

	<h1 style="margin: 0;">AKD5355</h1> <h2 style="margin: 0;">Evaluation board Rev.A for AK5355</h2>
---	---

<b>GENERAL DESCRIPTION</b>
----------------------------

AKD5355 is an evaluation board for the portable digital audio 16bit A/D converter, AK5355. The AKD5355 includes the input circuit and also has a digital interface transmitter. Further, the AKD5355 can evaluate direct interface with AKM's D/A converter evaluation board.

■ **Ordering guide**

AKD5355 --- Evaluation board for AK5355

<b>FUNCTION</b>
-----------------

- **Compatible with 2 types of interface**
  - **Direct interface with AKM's D/A converter evaluation boards**
  - **On-board AK4103 as DIT which transmits optical output**
- **BNC connector for an external clock input**

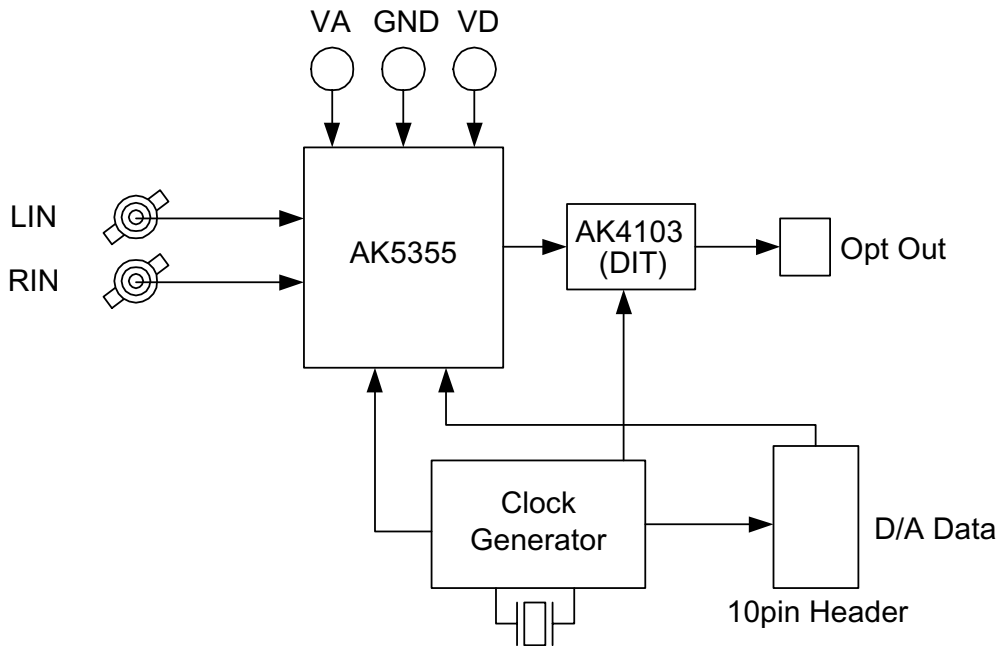

Figure 1. AKD5355 Block Diagram

\* Circuit diagram and PCB layout are attached at the end of this manual.

■ **Operation sequence**

1) Set up the power supply lines.

[VA]	(Orange)	= 2.1 ~ 3.6V	: typ. 3.0V, VA pin
[VD]	(Orange)	= 2.1 ~ VA	: typ. 3.0V, VD pin
[VCC]	(Red)	= 5.0V	: for digital logic except the AK5355
[AGND]	(Black)	= 0V	: for analog ground (including VSS of AK5355)
[DGND]	(Black)	= 0V	: for logic ground

Each supply line should be distributed from the power supply unit.  
VD and VA must be the same voltage level.

2) Set up the evaluation mode, jumper pins and DIP switches. (See the followings.)

3) Power on.

The AK5355 and AK4103 should be reset once bringing SW1 = SW3 = “L” upon power-up.

■ **Evaluation mode**

Applicable Evaluation Mode

- (1) Evaluation of A/D using DIT (Optical Link) <Default Setting>
- (2) All interface signals including master clock are fed externally.
- (3) Evaluation of A/D using DIT at MCLK = 384fs

(1) Evaluation of A/D using DIT (Optical Link)

PORT1 (DIT) is used. On board DIT (AK4103) converts A/D data to an audio biphasic signal, which is output through optical connector (TOTX176). It is possible to connect AKM’s D/A converter evaluation boards or the digital-amplifier that equips DIR input etc. Nothing should be connected to PORT2. DIT (AK4103) operates at SW3=“H”. When using an external clock through a BNC connector (J3), select “EXT” on JP4 (CLK) and short JP3 (XTE).

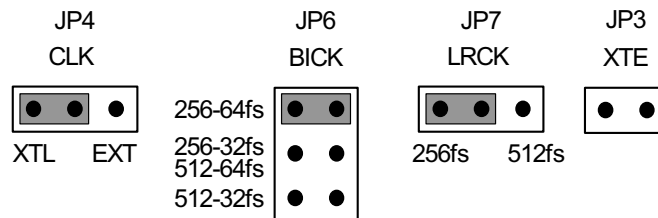

(2) All interface signals including master clock are fed externally.

All interface signals are provided to the AK5355 through PORT2. AKM’s D/A converter evaluation boards can be also connected to PORT2.

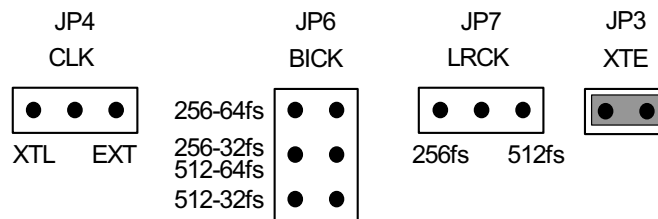

(3) Evaluation of A/D using DIT at MCLK=384fs.

PORT1 (DIT) is used. On board DIT (AK4103) is set to the master mode. The AK4103 provides BICK and LRCK to the AK5355 from an external master clock (MCLK). When using an external clock through a BNC connector (J3), select “EXT” on JP4 (CLK) and short JP3 (XTE). (Refer to a Table 1 ~ 3 for the set up of the DIP switch. The master mode should be selected in Table 2.)

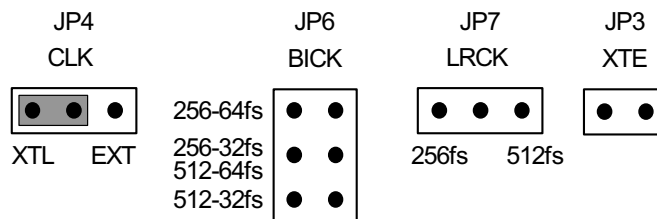

■ Jumpers Set up

1. JP1 (VD) : VD pin of the AK5355  
 VA : Supplied from “VA” connector via 10Ω.  
 VD : Supplied from “VD” connector.
2. JP2 (GND) : Connection between AGND and DGND.  
 OPEN : Both grounds are separated on board.  
 SHORT : Both grounds are connected on board.

■ DIP switch set up

[SW2]: Set up of AK5355 and AK4103 (Refer to the datasheet)

No.	Pin	default	Mode
1	SEL	L	H: Input Gain +15dB L: Input Gain +0dB
2	5355_DIF	L	H:I2S L:16bit Left justified
3	4103_DIF1	L	See Table 2
4	4103_DIF0	L	
5	CKS1	L	See Table 3
6	CKS0	H	

Table 1. Set up for AK5355 and AK4103

4103_DIF1	4103_DIF0	Mode	Clock mode
OFF	OFF	24bit, Left justified	Slave mode
OFF	ON	24bit, I <sup>2</sup> S	
ON	OFF	24bit, Left justified	Master mode
ON	ON	24bit, I <sup>2</sup> S	

Table 2. Set up of Interface Format

CKS1	CKS0	MCLK
0	0	no using
0	1	256fs
1	0	384fs
1	1	512fs

Table 3. Set up of CKS0 and CKS1

■ The function of the toggle SW

Upper-side is “H” and lower-side is “L”.

[SW1] (PDN): Resets the AK5355. Keep “H” during normal operation.

[SW3] (DIT): Resets the AK4103. Keep “H” during normal operation.

■ Input circuit

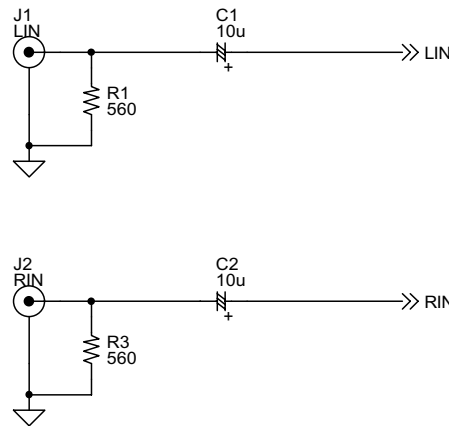

Figure 2. LIN/RIN Input circuit on board

\* AKM assumes no responsibility for the trouble when using the circuit examples.

**MEASUREMENT RESULTS**

[Measurement condition]

- Measurement unit: Audio Precision, System Two, Cascade
- MCLK : 256fs
- BCLK : 64fs
- fs : 44.1kHz
- Bit : 16bit
- Power Supply : VA=VD=3.0V
- Interface : DIT (AK4103)
- Temperature : Room

•Gain=0dB (SEL="L")

	LIN	RIN	Filter
S/(N+D) (-0.5dB)	85.1[dB]	85.3[dB]	20kHzLPF
DR (-60dB)	89.4[dB]	89.4[dB]	20kHzLPF
	91.8[dB]	91.9[dB]	20kHzLPF+A-Weighted
S/N	89.4[dB]	89.4[dB]	20kHzLPF
	91.9[dB]	91.9[dB]	20kHzLPF+A-Weighted

•Gain=+15dB (SEL="H")

	LIN	RIN	Filter
S/(N+D) (-0.5dB)	81.7[dB]	81.3[dB]	20kHzLPF
DR (-60dB)	81.2[dB]	81.5[dB]	20kHzLPF
	84.3[dB]	84.3[dB]	20kHzLPF+A-Weighted
S/N	81.5[dB]	81.7[dB]	20kHzLPF
	84.4[dB]	84.3[dB]	20kHzLPF+A-Weighted

• Plot

[Gain = 0dB]

AKM

AK5355 THD + N vs Amplitude (fin=1kHz, Gain=0dB)

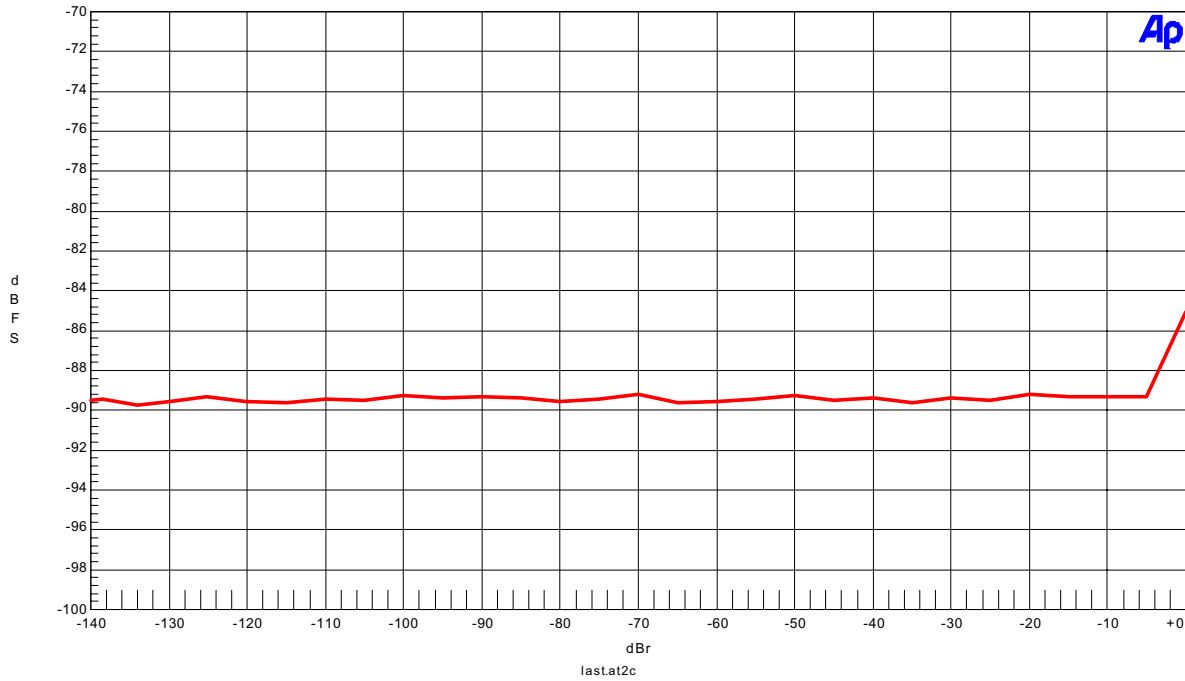

Figure 1. THD+N vs. Input Level

AKM

AK5355 THD + N vs Input Frequency (Input Level=-0.5dB, Gain=+15dB)

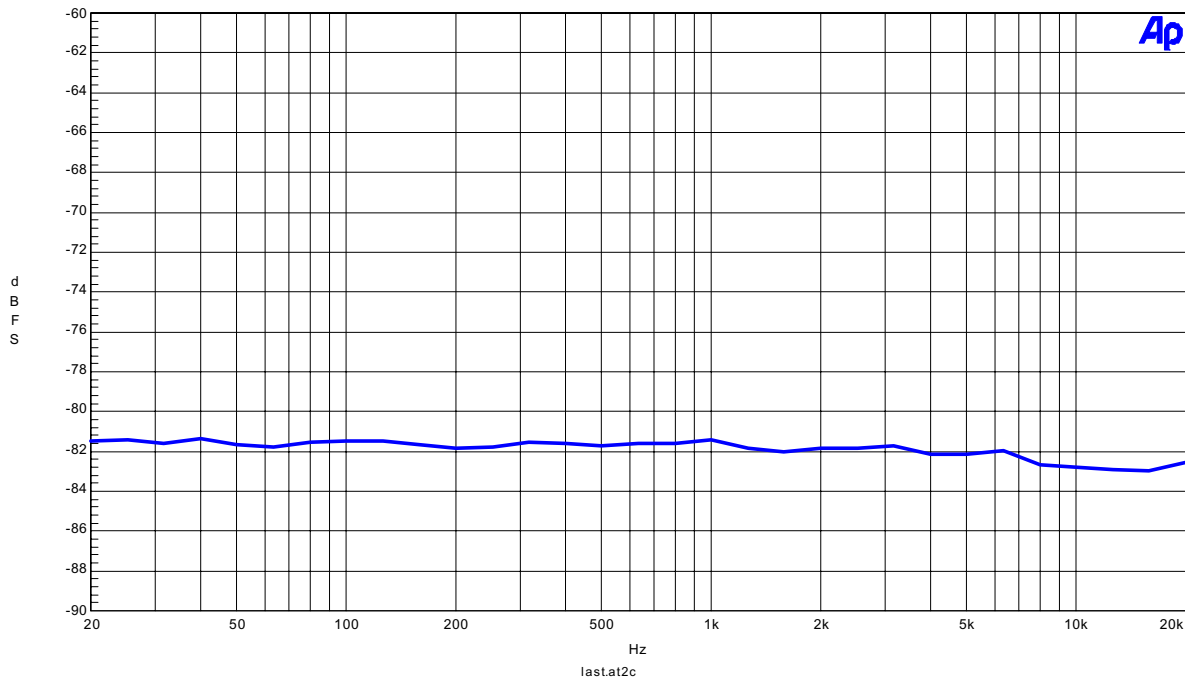

Figure 2. THD+N vs. Input Frequency

AKM

AK5355 Linearity (fin=1kHz, Gain=0dB)

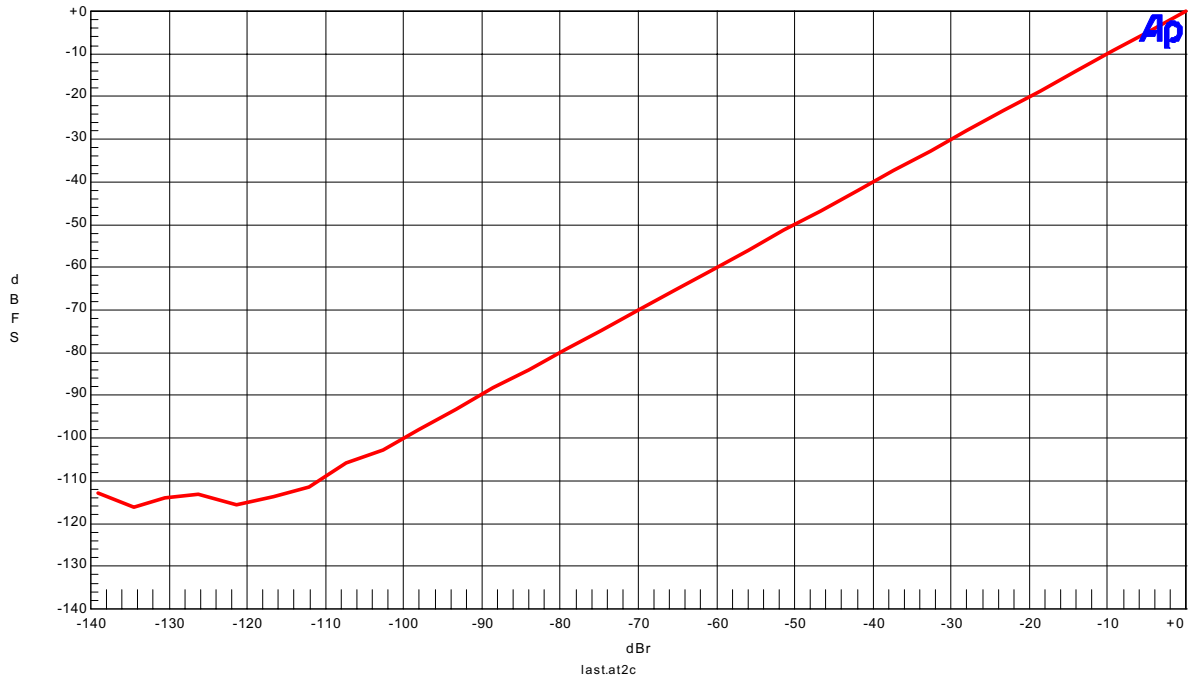

Figure 3. Linearity

AKM

AK5355 Frequency Response (Input Level-0.5dB, Gain=0dB)

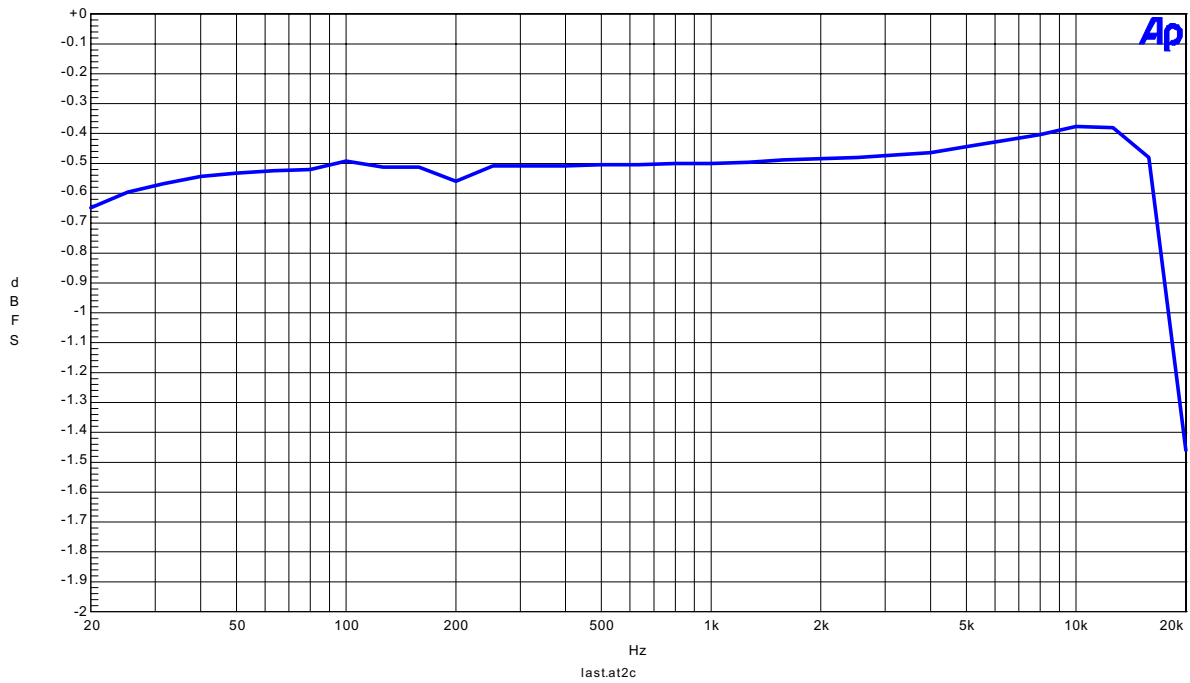

Figure 4. Frequency Response

AKM

AK5355 Crosstalk (Gain=0dB)

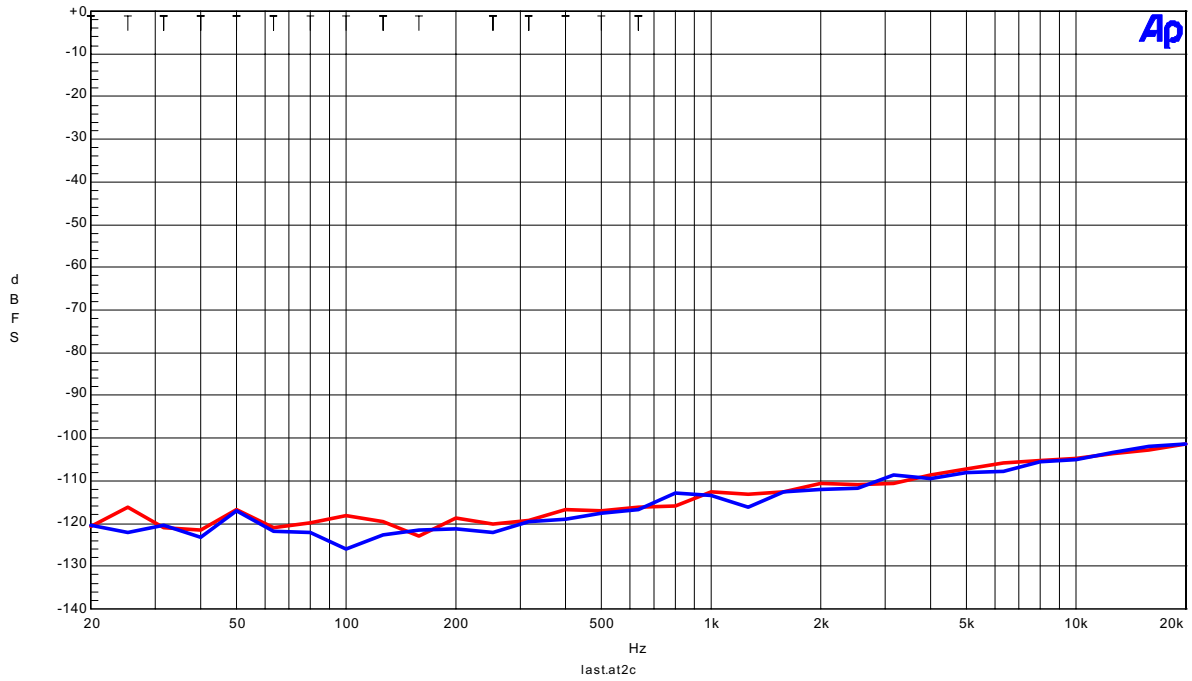

Figure 5. Crosstalk

AKM

AK5355 FFT (Input Level=-0.5dB, fiin=1kHz, Gain=0dB)

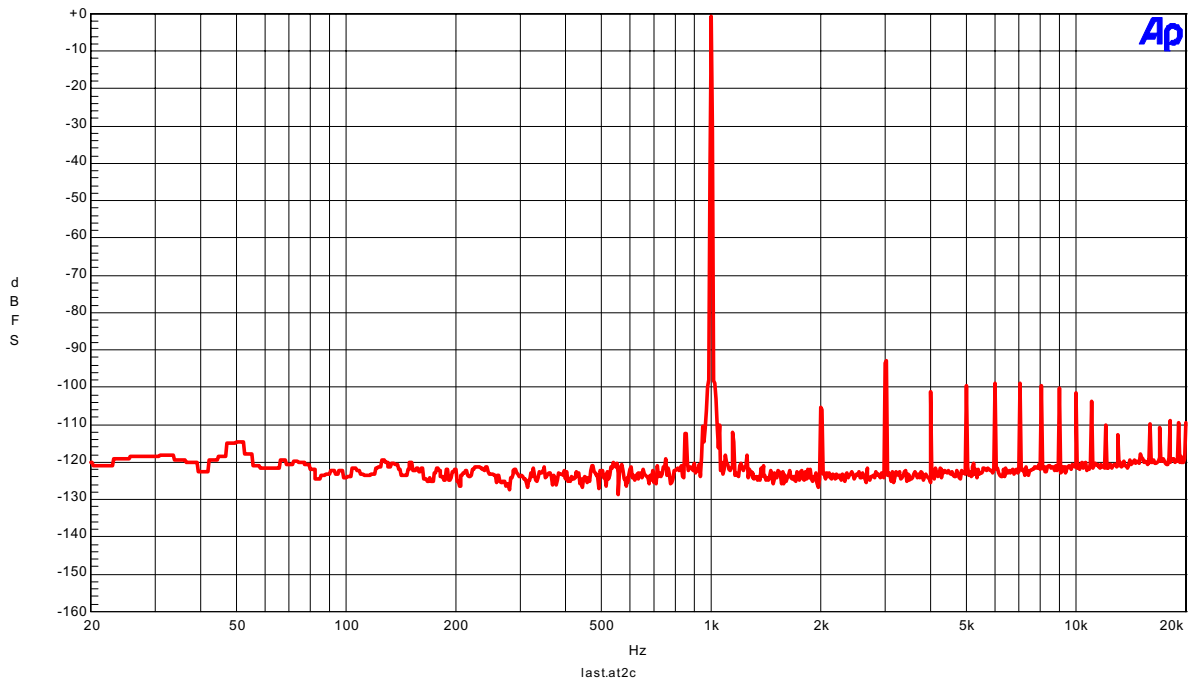

Figure 6. FFT Plot



AKM

AK5355 FFT (Input Level=-60dB, fiin=1kHz, Gain=0dB)

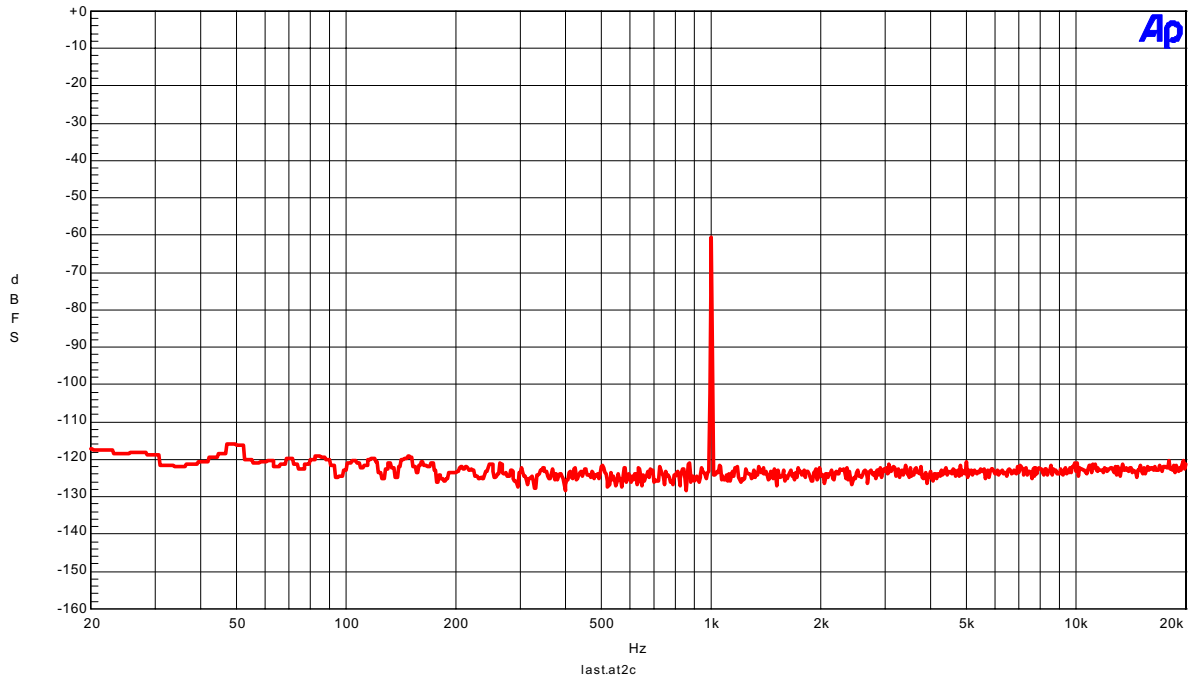

Figure 7. FFT Plot

AKM

AK5355 FFT (noise floor, Gain=0dB)

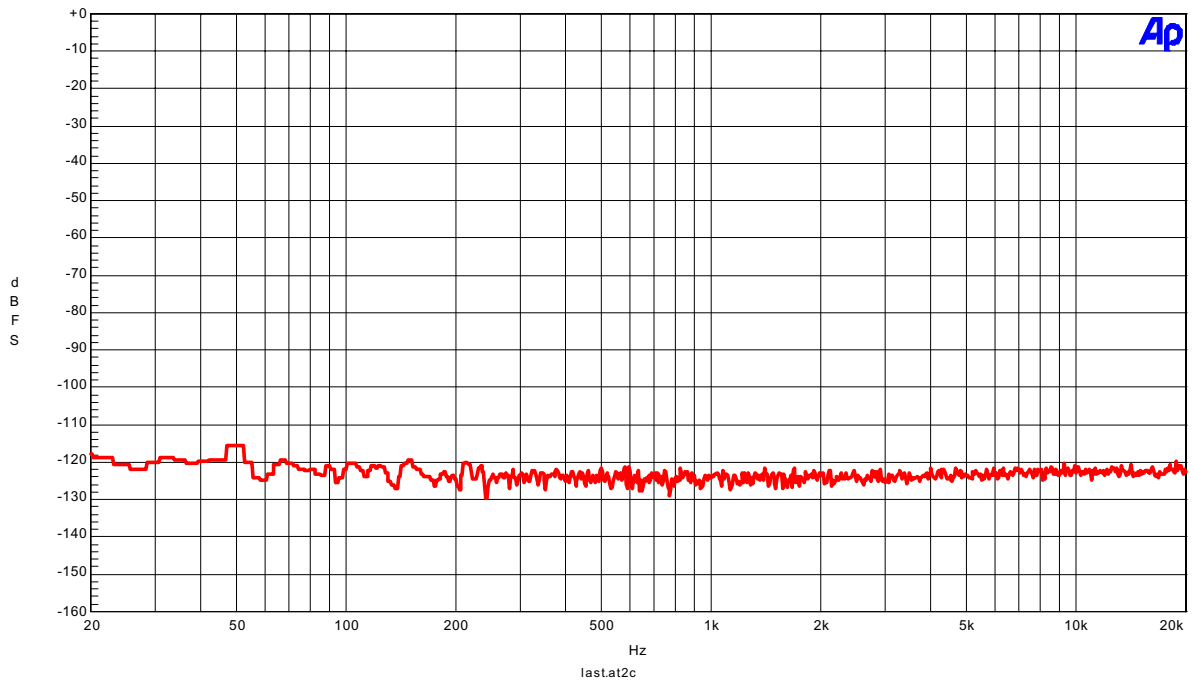

Figure 8. FFT Plot

[Gain = +15dB]

AKM

AK5355 THD + N vs Amplitude (fin=1kHz, Gain=+15dB)

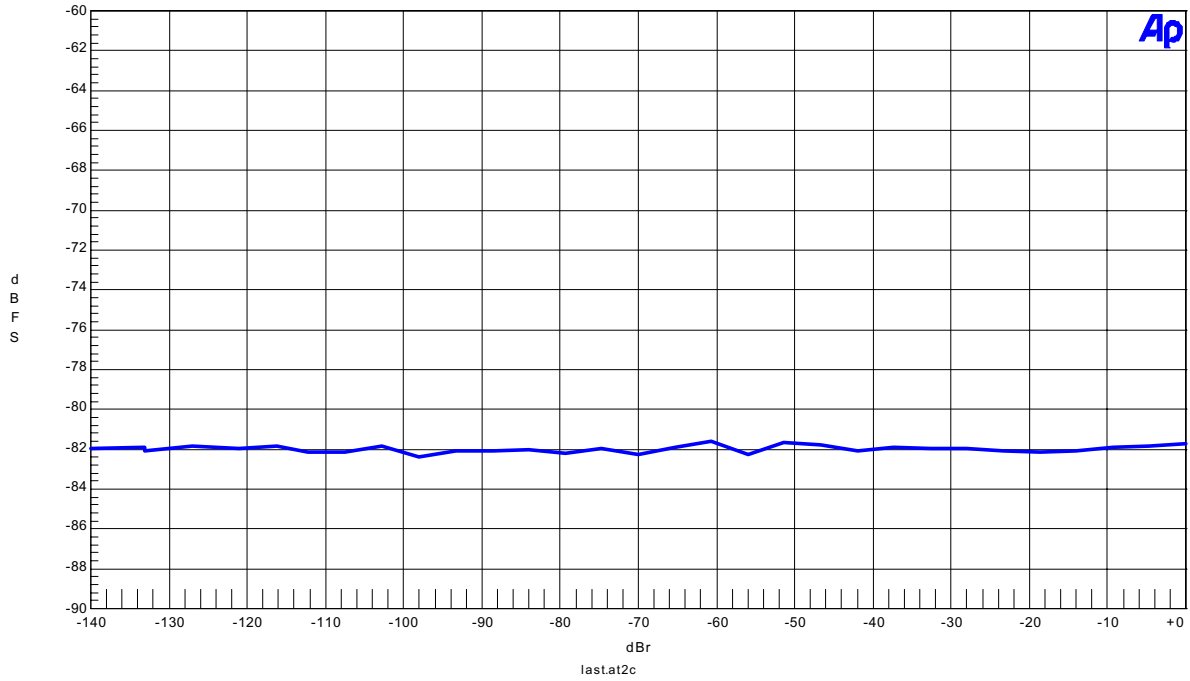

Figure 9. THD+N vs. Input Level

AKM

AK5355 THD + N vs Input Frequency (Input Level=-0.5dB, Gain=+15dB)

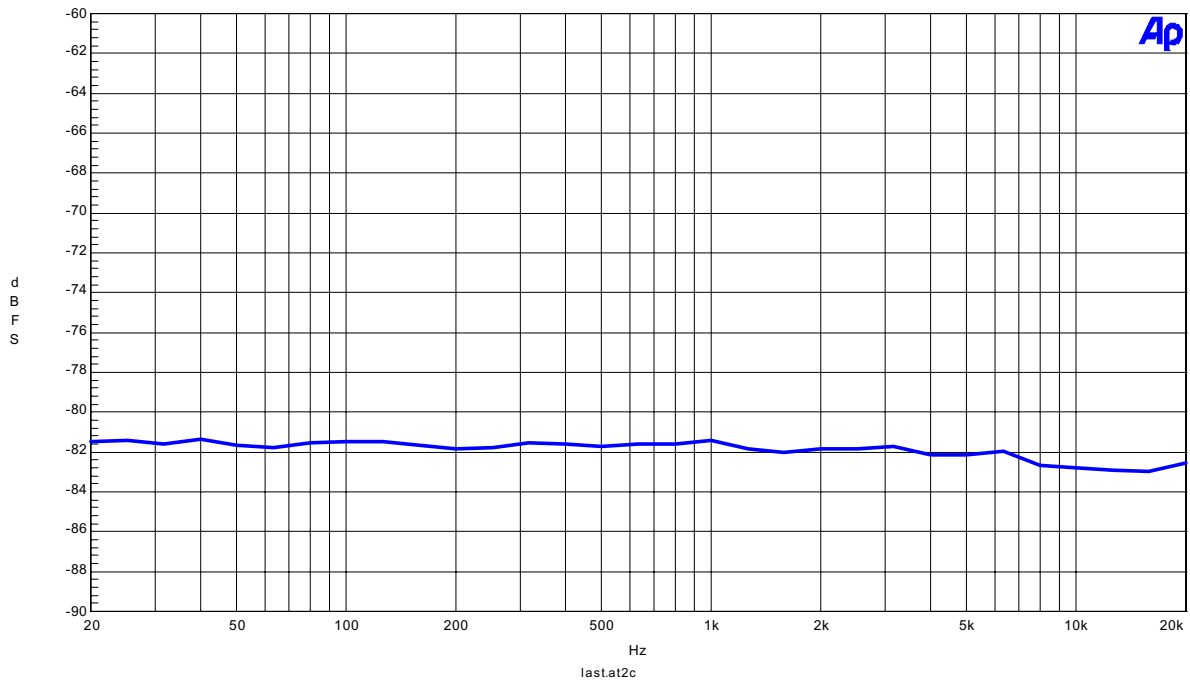

Figure 10. THD+N vs. Input Frequency

AKM

AK5355 Linearity (Gain=+15dB)

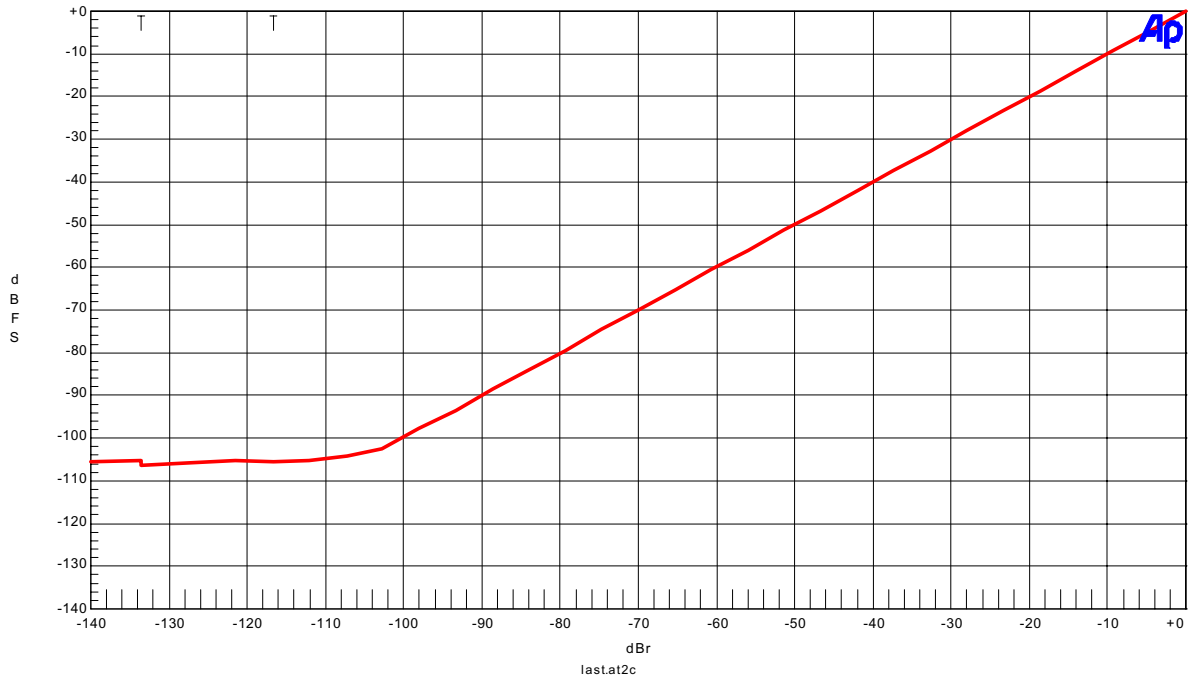

Figure 11. Linearity

AKM

AK5355 Frequency Response (Gain=+15dB)

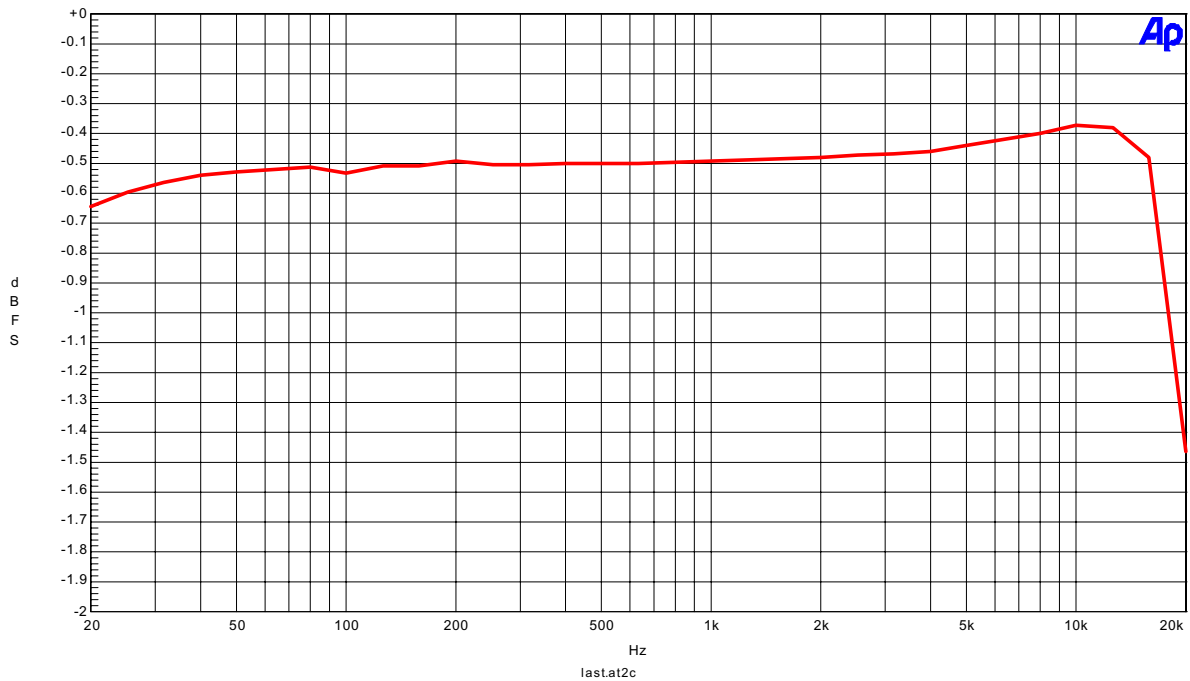

Figure 12. Frequency Response

AKM

AK5355 Crosstalk (Gain=+15dB)

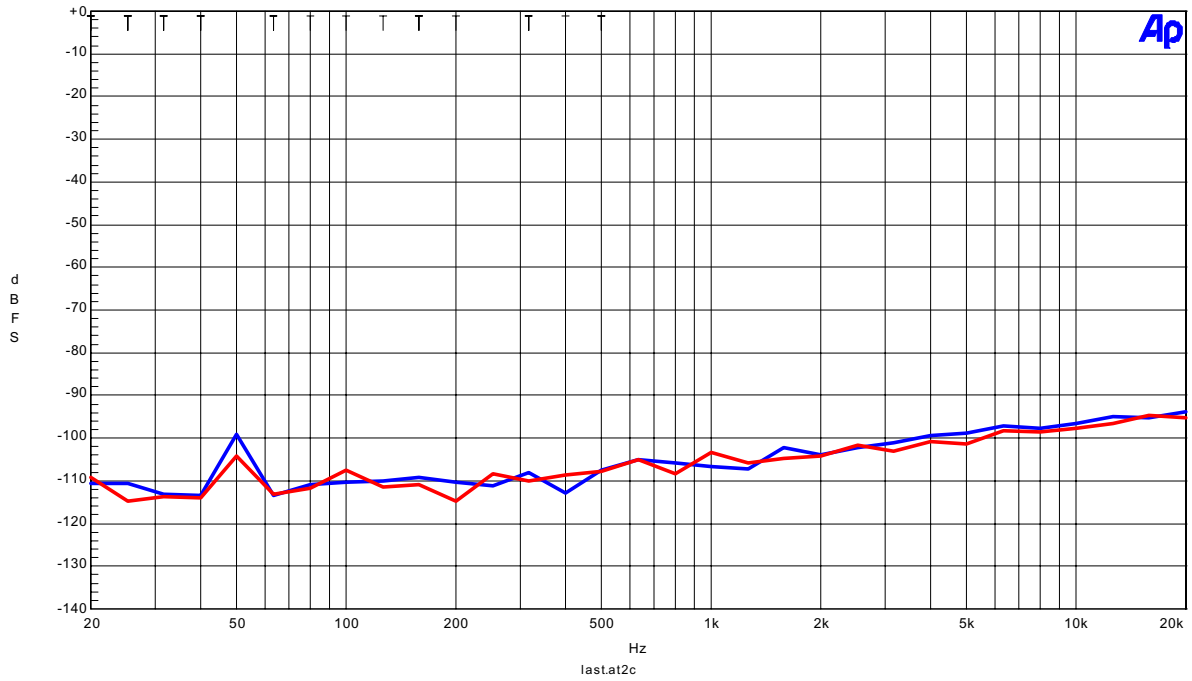

Figure 13. Crosstalk

AKM

AK5355 FFT (Input Level-0.5dB,fin=1kHz, Gain=+15dB)

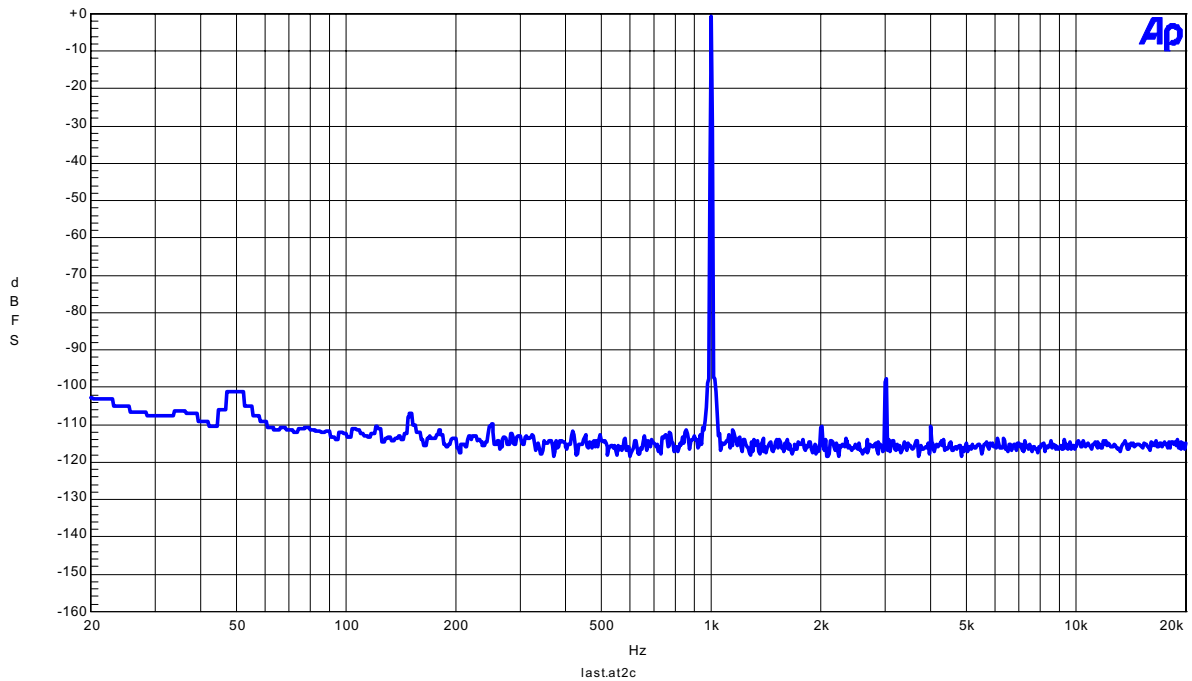

Figure 14. FFT Plot

AKM

AK5355 FFT (Input Level=-60dB,fin=1kHz, Gain=+15dB)

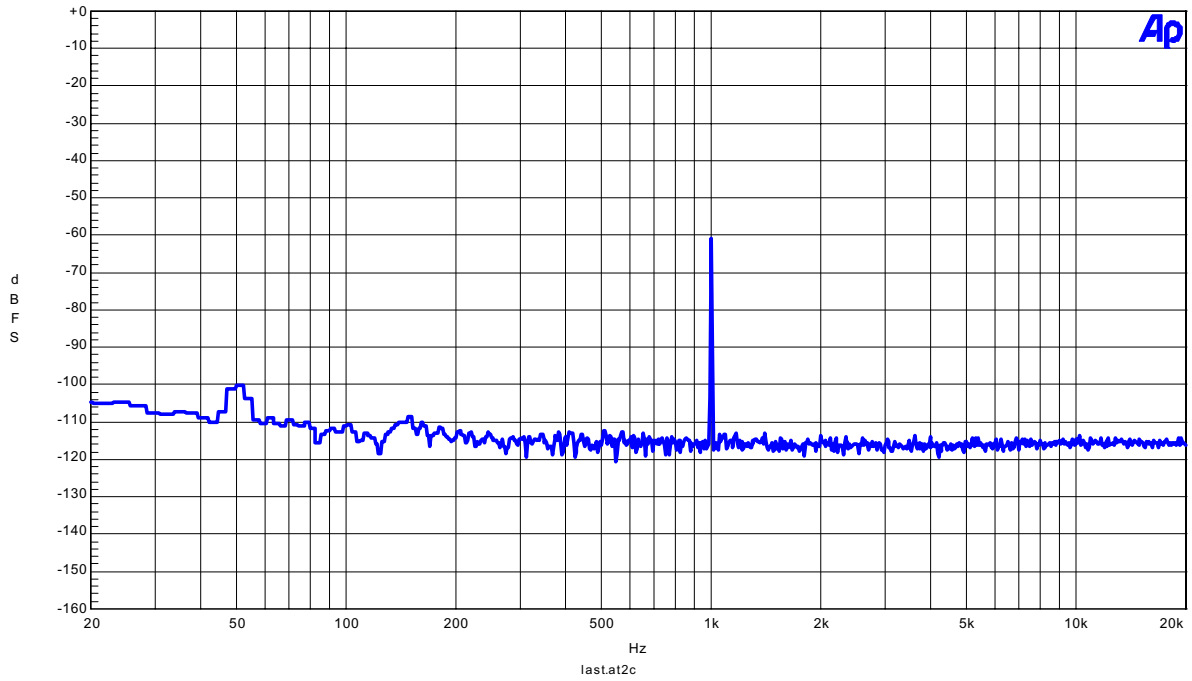

Figure 15. FFT Plot

AKM

AK5355 FFT (noise floor, Gain=+15dB)

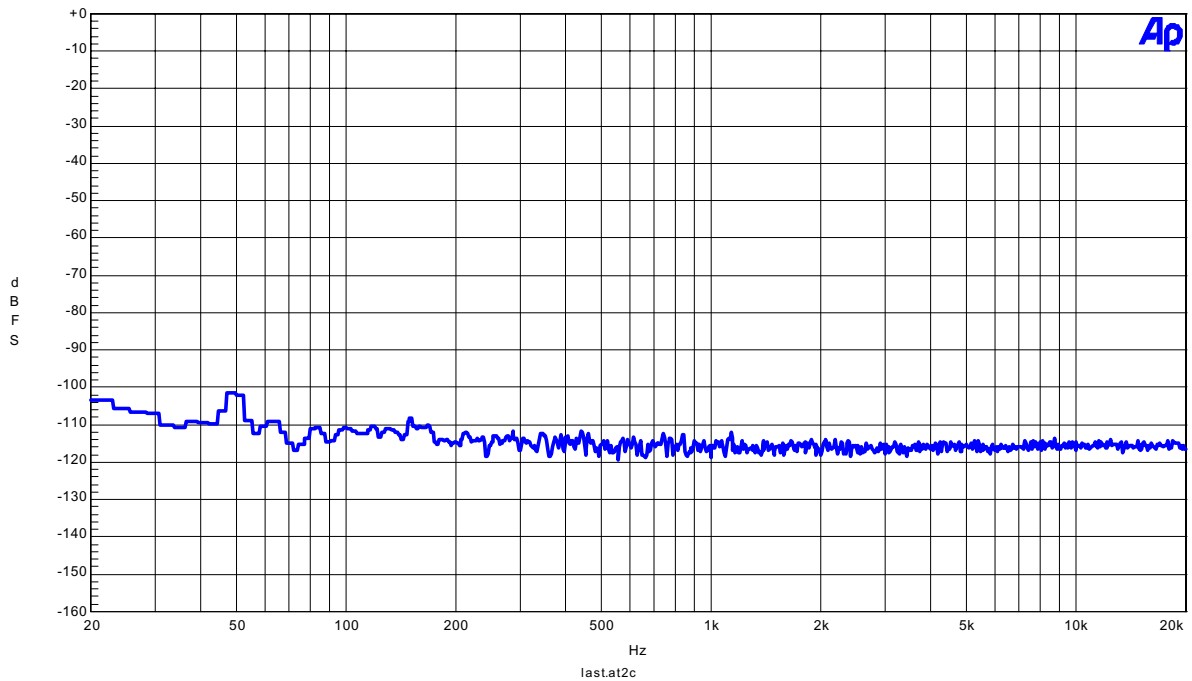
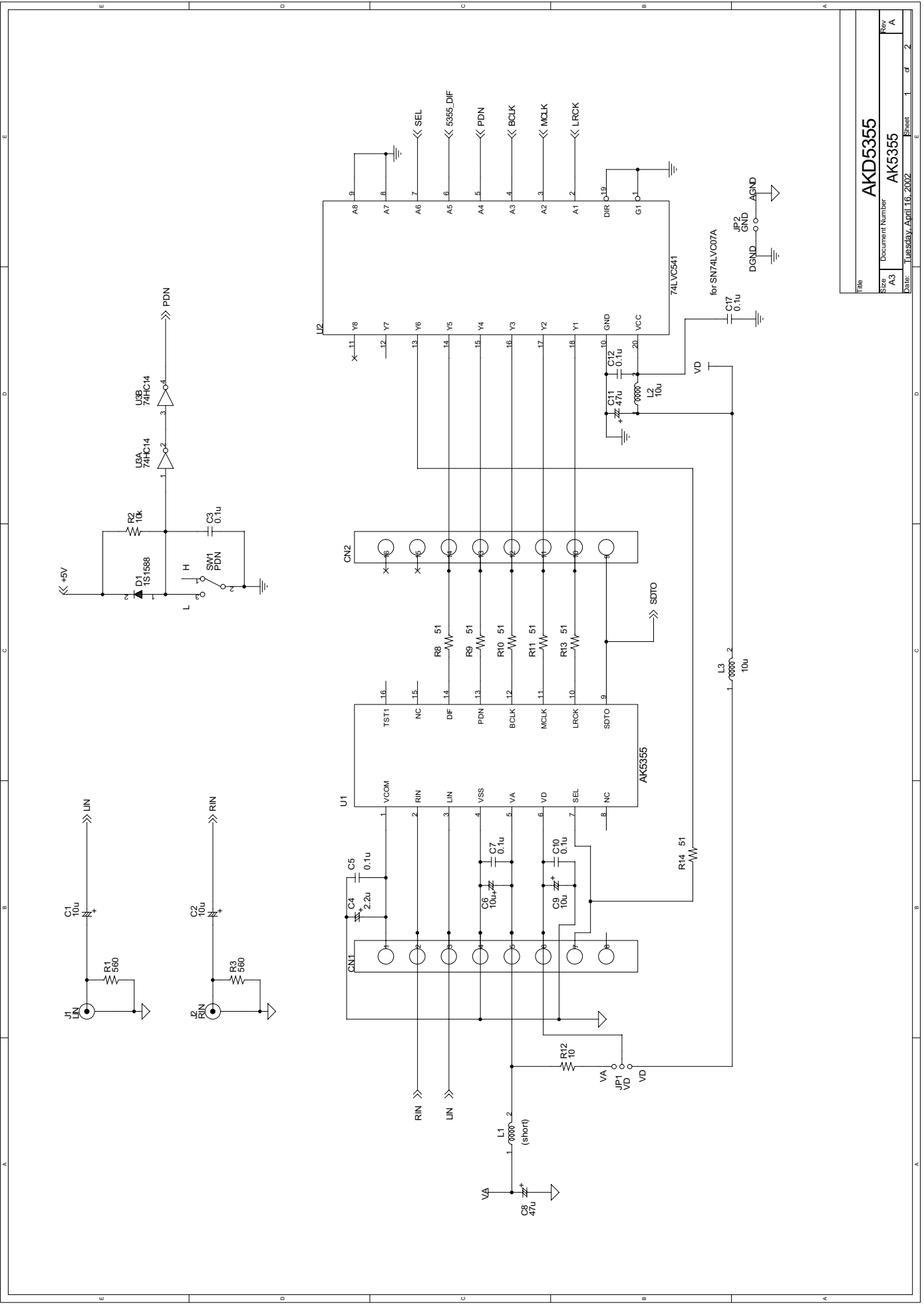

Figure 16. FFT Plot

IMPORTANT NOTICE

- These products and their specifications are subject to change without notice. Before considering any use or application, consult the Asahi Kasei Microsystems Co., Ltd. (AKM) sales office or authorized distributor concerning their current status.
- AKM assumes no liability for infringement of any patent, intellectual property, or other right in the application or use of any information contained herein.
- Any export of these products, or devices or systems containing them, may require an export license or other official approval under the law and regulations of the country of export pertaining to customs and tariffs, currency exchange, or strategic materials.
- AKM products are neither intended nor authorized for use as critical components in any safety, life support, or other hazard related device or system, and AKM assumes no responsibility relating to any such use, except with the express written consent of the Representative Director of AKM. As used here:
  - (a) A hazard related device or system is one designed or intended for life support or maintenance of safety or for applications in medicine, aerospace, nuclear energy, or other fields, in which its failure to function or perform may reasonably be expected to result in loss of life or in significant injury or damage to person or property.
  - (b) A critical component is one whose failure to function or perform may reasonably be expected to result, whether directly or indirectly, in the loss of the safety or effectiveness of the device or system containing it, and which must therefore meet very high standards of performance and reliability.
- It is the responsibility of the buyer or distributor of an AKM product who distributes, disposes of, or otherwise places the product with a third party to notify that party in advance of the above content and conditions, and the buyer or distributor agrees to assume any and all responsibility and liability for and hold AKM harmless from any and all claims arising from the use of said product in the absence of such notification.



Title		AKD5355	
Size	A3	Document Number	AK5355
Rev	A	Date	Tuesday, April 16, 2002
Sheet	1	of	2

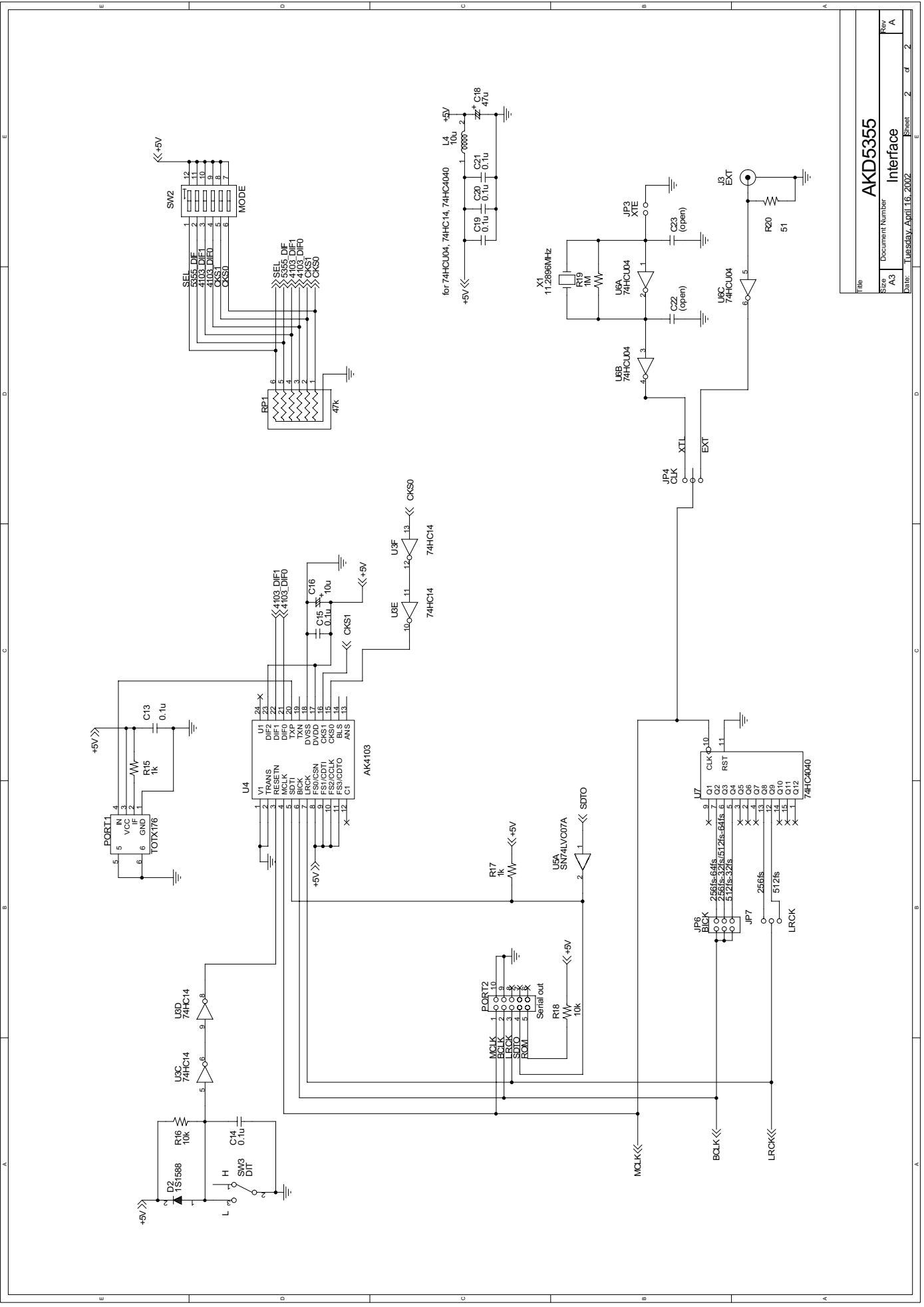

Title		AKD5355	
Size	Document Number	Interface	
A3			
Rev	Date	Tuesday, April 16, 2002	Sheet 2 of 2



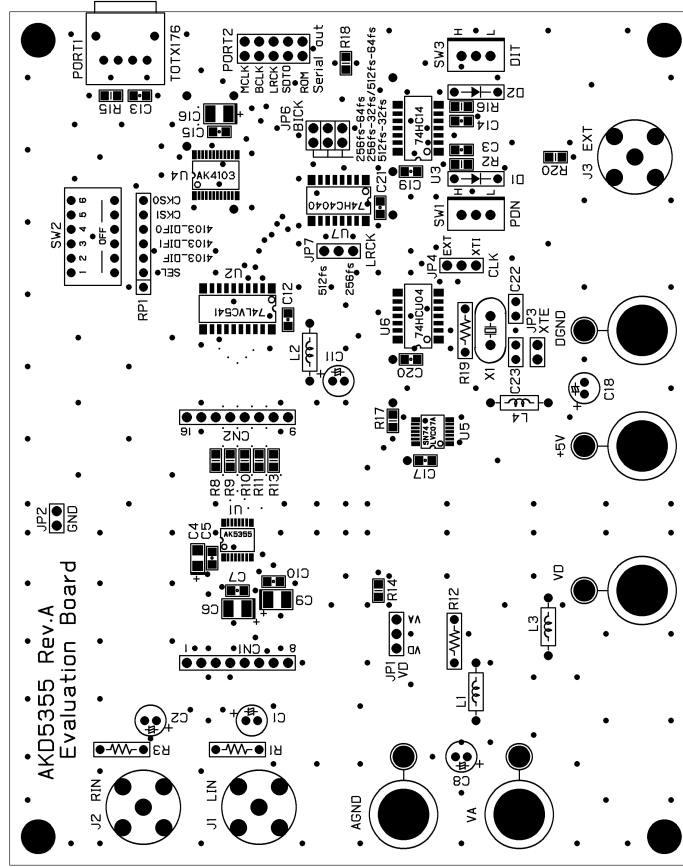

AKD5355 Rev.A L1 SR SILK

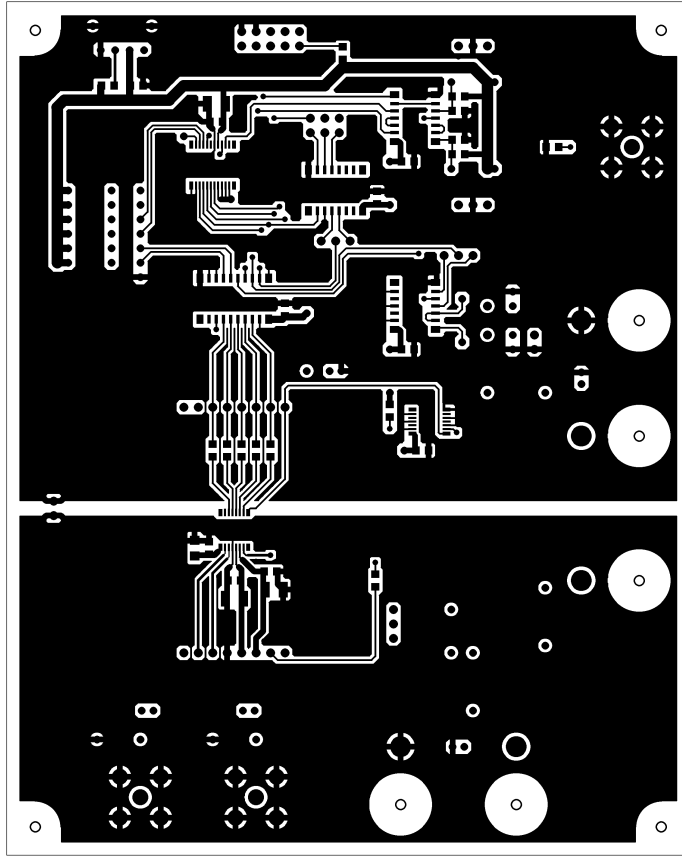

AKD5355 Rev.A L1

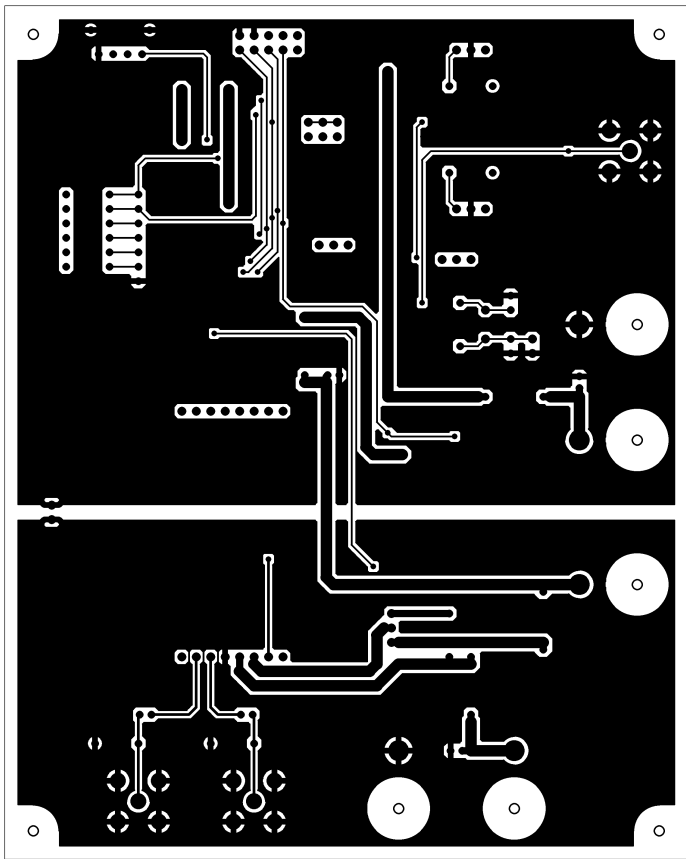

VKD2322 Rev.A FS