



AKD5385A

Evaluation board Rev.A for AK5385A

GENERAL DESCRIPTION

AKD5385A is an evaluation board for the digital audio 24bit 192kHz A/D converter, AK5385A. The AKD5385A includes the input circuit and also has a digital interface transmitter. Further, the AKD5385A can achieve the interface with digital audio systems via opt-connector.

■ **Ordering guide**

AKD5385A --- Evaluation board for AK5385A

FUNCTION

- **DIT with optical output**
- **BNC connector for an external clock input**

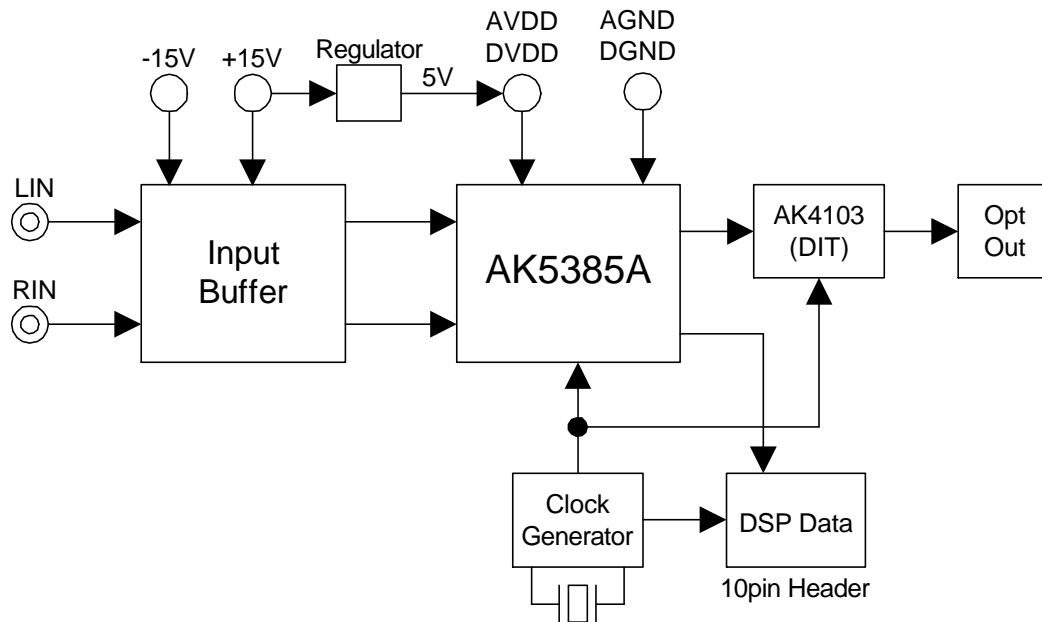

Figure 1. AKD5385A Block Diagram

* Circuit diagram and PCB layout are attached at the end of this manual.

■ **Operation sequence**

- 1) Set up the power supplies lines.

[AVDD]	(red)	= 4.75 ~ 5.25V	: for AVDD of AK5385A (typ. 5.0V)
[DVDD]	(red)	= 3.0 ~ 5.25V	: for DVDD of AK5385A (typ. 3.3V)
[+15V]	(green)	= +15V	: for Op-amp
[-15V]	(blue)	= -15V	: for Op-amp
[VCC]	(red)	= 5V	: for logic
[AGND]	(black)	= 0V	: for analog ground
[DGND]	(black)	= 0V	: for logic ground

Each supply line should be distributed from the power supply unit.

- 2) Set up the evaluation mode, jumper pins and DIP switches. (See the followings.)
- 3) Power on.

The AK5385A and AK4103 should be reset once bringing SW1 = “L” upon power-up.

■ **Evaluation mode**

(1) Slave Mode

(1-1) A/D evaluation using DIT function of AK4103

PORT1 (DIT) is used. DIT generates audio bi-phase signal from received data and which is output through optical connector (TOTX176). It is possible to connect AKM’s D/A converter evaluation boards on the digital-amplifier which equips DIR input. Nothing should be connected to PORT2 (DSP). In case of using external clock through a BNC connector (J3), select EXT on JP8 (CLK) and short JP5 (XTE) and open JP10 (EXT).

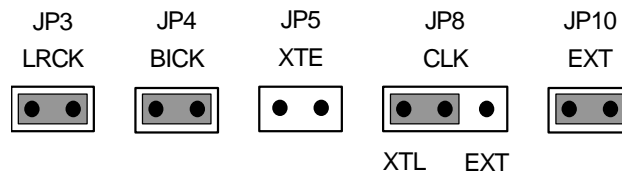

(1-2) Feeding all clocks from PORT2 (DSP)

Under the following set-up, all external clocks (MCLK, BICK, LRCK) can be fed through PORT2 (DSP). The A/D converted data is output from SDTO of PORT2 (DSP). Also, the A/D converted data is output through optical connector (TOTX176).

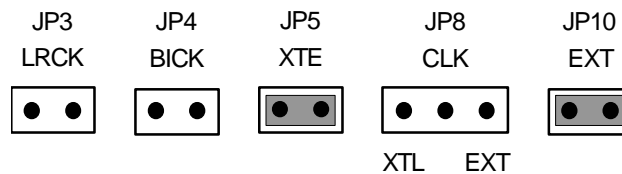

(2) Master Mode

(2-1) A/D evaluation using DIT function of AK4103

PORT1 (DIT) is used. DIT generates audio bi-phase signal from received data and which is output through optical connector (TOTX176). It is possible to connect AKM's D/A converter evaluation boards on the digital-amplifier which equips DIR input. Nothing should be connected to PORT2 (DSP). In case of using external clock through a BNC connector (J3), select EXT on JP8 (CLK) and short JP5 (XTE) and open JP10 (EXT).

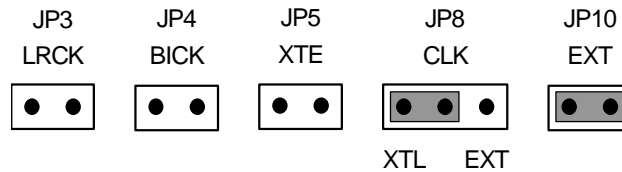

■ Other jumper pins set up

1. JP1 (GND) : Analog ground and Digital ground
 OPEN : Separated.
 SHORT : Common. (The connector "DGND" can be open.) <Default>
2. JP2 (AVDD) : Select AVDD for AK5385A
 AVDD : Supply from AVDD connector <Default>
 REG : Supply from regulator. AVDD connector should be supplied +15V.
3. JP6 (BCFS) : Select BICK frequency
 256 : In case of MCLK=256fs/512fs <Default>
 384 : In case of MCLK=128fs/384fs
4. JP7 (MCLK) : Supply MCLK frequency for 74HC4040
 256 : In case of MCLK=128fs/256fs
 512 : In case of MCLK=512fs <Default>
 384/768 : In case of MCLK=384fs
5. JP9 (LRFS) : Select LRCK frequency
 256 : In case of MCLK=256fs/512fs <Default>
 384 : In case of MCLK=128fs/384fs

■ Clock Setting

Mode	fs	MCLK	JP6(BCFS)	JP7(MCLK)	JP9(LRFS)
Normal Speed	8kHz	256fs = 2.048MHz	256	256	256
		384fs = 3.072MHz	384	384/768	384
		512fs = 4.096MHz	256	512	256
	32kHz	256fs = 8.192MHz	256	256	256
		384fs = 12.288MHz	384	384/768	384
		512fs = 16.384MHz	256	512	256
	44.1kHz	256fs = 11.2896MHz	256	256	256
		384fs = 16.9344MHz	384	384/768	384
		512fs = 22.5792MHz	256	512	256
	48kHz	256fs = 12.288MHz	256	256	256
		384fs = 18.432MHz	384	384/768	384
		512fs = 24.576MHz	256	512	256
Double Speed	88.2kHz	256fs = 22.5792MHz	256	256	256
		384fs = 33.8688MHz	384	384/768	384
	96kHz	256fs = 24.576MHz	256	256	256
		384fs = 36.864MHz	384	384/768	384
Quad Speed	176.4kHz	128fs = 22.5792MHz	384	256	384
	192kHz	128fs = 24.576MHz	384	256	384

Default

Table 1. Clock Setting

■ DIP Switch set up

[SW2] (MODE): Setting the evaluation mode for AK5385A and AK4103
ON is “H”, OFF is “L”.

No.	Name	OFF (“L”)	ON (“H”)	Default
1	CKS0	See Table 3		OFF (“L”)
2	CKS1			ON (“H”)
3	DIF	MSB justified	I ² S Compatible	OFF (“L”)
4	M/S	Slave mode	Master mode	OFF (“L”)
5	DFS0	See Table 4		OFF (“L”)
6	DFS1			OFF (“L”)
7	HPFE	HPF Disable	HPF Enable	ON (“H”)
8	DIT1	See Table 5		ON (“H”)
9	DIT0			OFF (“L”)
10	-	N/A	N/A	OFF (“L”)

Table 2. Mode Setting

CKS1	CKS0	MCLK Frequency	Default
L	L	256fs	
L	H	128fs	
H	L	512fs	
H	H	384fs	

Table 3. MCLK Frequency

DFS1	DFS0	LRCK Frequency	Default
L	L	8kHz ≤ fs ≤ 54kHz	
L	H	54kHz < fs ≤ 108kHz	
H	L	108kHz < fs ≤ 216kHz	
H	H	N/A	

Table 4. Sampling Speed

Mode	DIT1	DIT0	MCLK	fs	Default
0	L	L	256fs	~ 108kHz	
1	L	H	128fs	~ 216kHz	
2	H	L	512fs	~ 54kHz	
3	H	H	384fs	~ 54kHz	

Table 5. MCLK Frequency Setting of AK4103

■ The function of the toggle SW

Upper-side is “H” and lower-side is “L”.

[SW1] (PDN): Resets the AK5385A and AK4103. Keep “H” during normal operation.

■ Input Circuit

Analog signal is input to LIN/RIN pins via J1, J2 connectors.

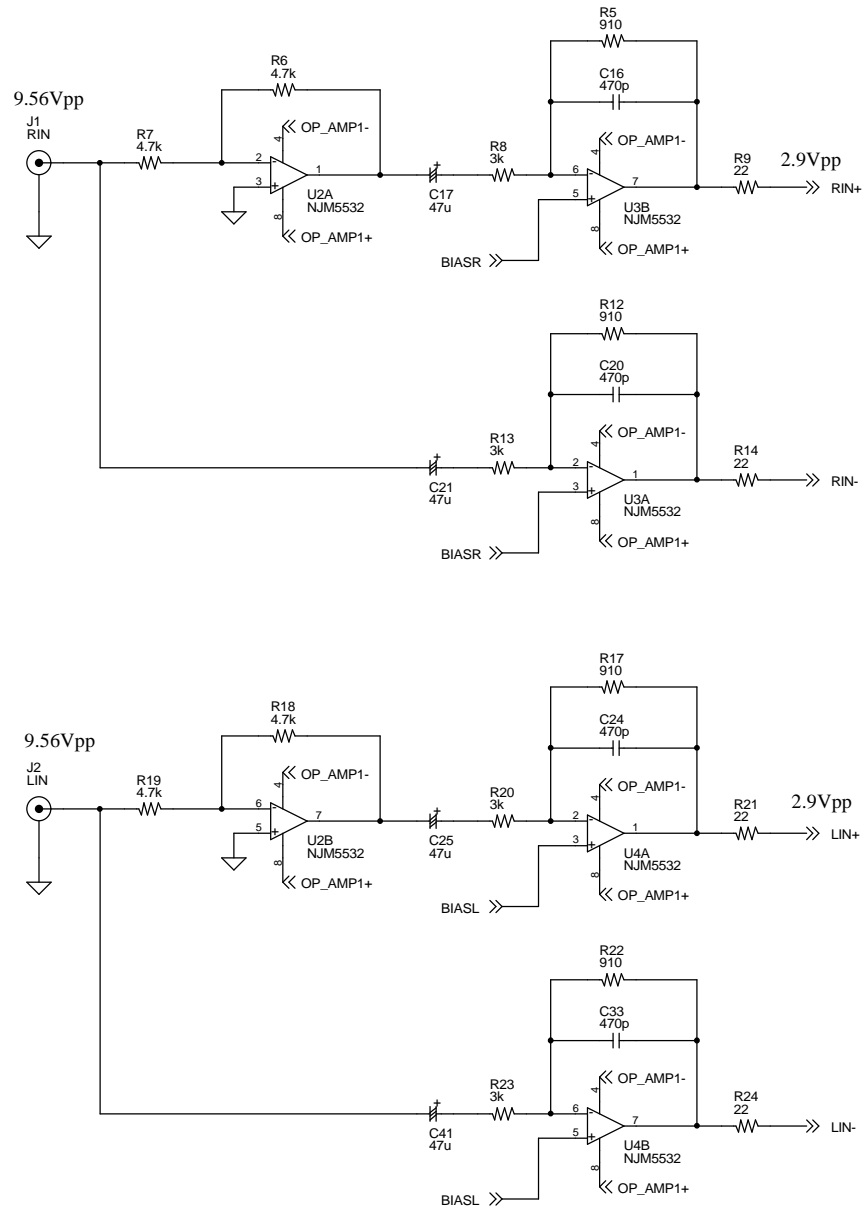

Figure 2. LIN/RIN Input circuits

* AKM assumes no responsibility for the trouble when using the circuit examples.

MEASUREMENT RESULTS

[Measurement condition]

- Measurement unit : Audio Precision, System Two Cascade
- MCLK : 256fs@fs=48kHz/96kHz, 128fs@fs=192kHz
- BICK : 64fs
- fs : 48kHz, 96kHz, 192kHz
- Band width : 10Hz ~ 20kHz@fs=48kHz, 10Hz ~ 40kHz@fs=96kHz/192kHz
- Bit : 24bit
- Power Supply : AVDD = 5.0V, DVDD = 3.3V
- Interface : DIT@fs=48kHz/96kHz, Serial port@fs=192kHz
- Temperature : Room

[Measurement Results]

Parameter	Result (Lch/Rch)	Unit
ADC Analog Input Characteristics:		
S/(N+D)		
(fs=48kHz, -1dBFS, BW=20kHz)	101.3 / 101.4	dB
(fs=48kHz, -1dBFS, BW=20kHz, VREF Cap=100μF, Note)	103.5 / 104.1	dB
(fs=96kHz, -1dBFS, BW=40kHz)	99.5 / 100.2	dB
(fs=192kHz, -1dBFS, BW=40kHz)	99.4 / 100.2	dB
D-Range		
(fs=48kHz, -60dBFS, A-weighted)	114.0 / 114.0	dB
(fs=96kHz, -60dBFS, BW=40kHz)	106.1 / 107.2	dB
(fs=192kHz, -60dBFS, BW=40kHz)	105.6 / 107.2	dB
S/N		
(fs=48kHz, A-weighted)	114.0 / 114.0	dB
(fs=96kHz, BW=40kHz)	106.1 / 107.2	dB
(fs=192kHz, BW=40kHz)	105.6 / 107.2	dB
Interchannel Isolation		
(fs=48kHz)	125.1 / 123.3	dB
(fs=96kHz)	121.6 / 123.3	dB
(fs=192kHz)	117.6 / 123.6	dB

Note. 10μF is mounted on the VREFL and VREFR pins on the evaluation board.

[ADC Plot : fs=48kHz]

AKM

AK5385A THD+N vs. Input Level
AVDD=5.0V, DVDD=3.3V, fs=48kHz, fin=1kHz

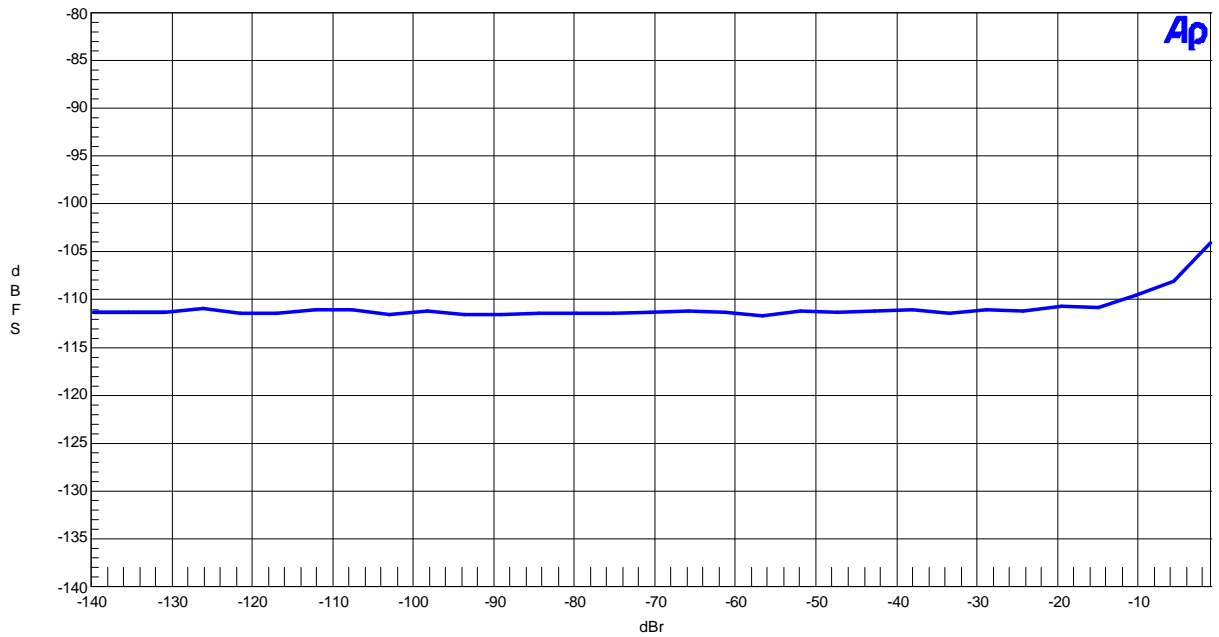

Figure 1. THD+N vs. Input Level

AKM

AK5385A THD+N vs. Input Frequency
AVDD=5.0V, DVDD=3.3V, fs=48kHz, Input=-1.0dBr

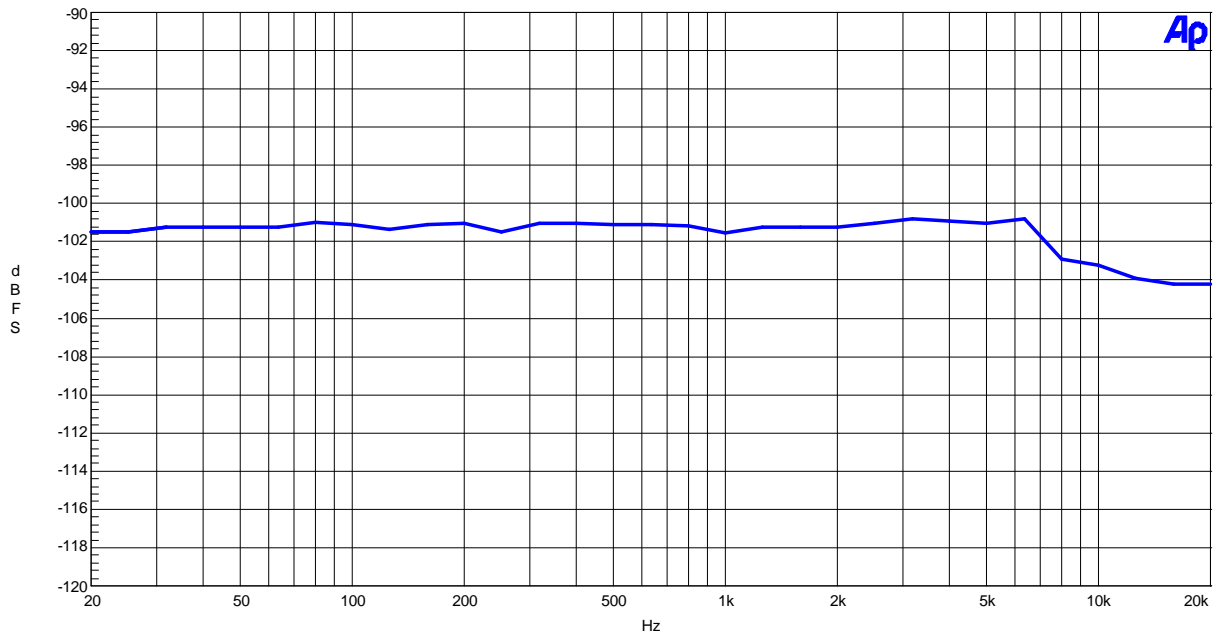

Figure 2. THD+N vs. Input Frequency

AKM

AK5385A Linearity
AVDD=5.0V, DVDD=3.3V, fs=48kHz, fin=1kHz

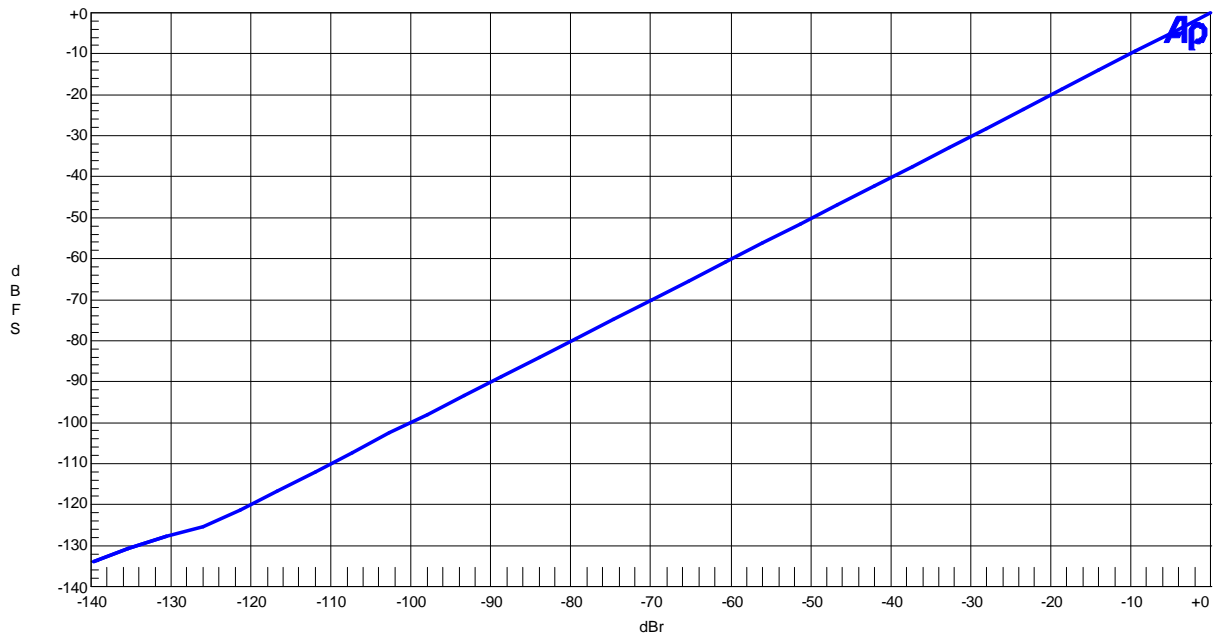

Figure 3. Linearity

AKM

AK5385A Frequency Response
AVDD=5.0V, DVDD=3.3V, fs=48kHz, Input=-1.0dBr

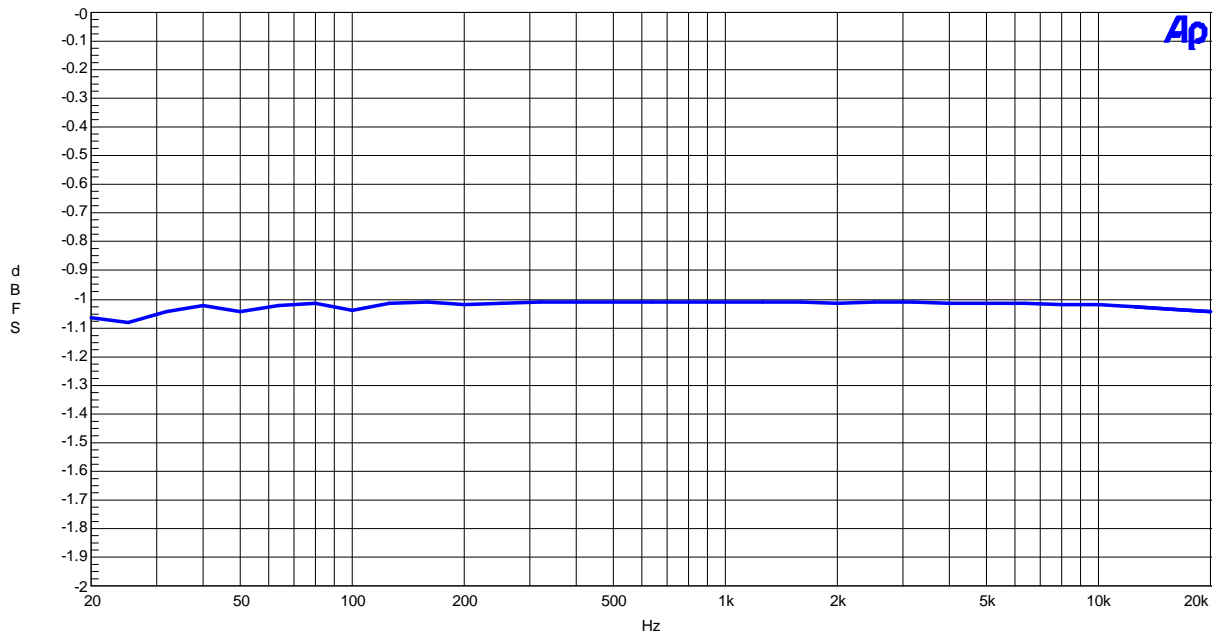

Figure 4. Frequency Response

AKM

AK5385A Crosstalk
AVDD=5.0V, DVDD=3.3V, fs=48kHz, Input=-1.0dB

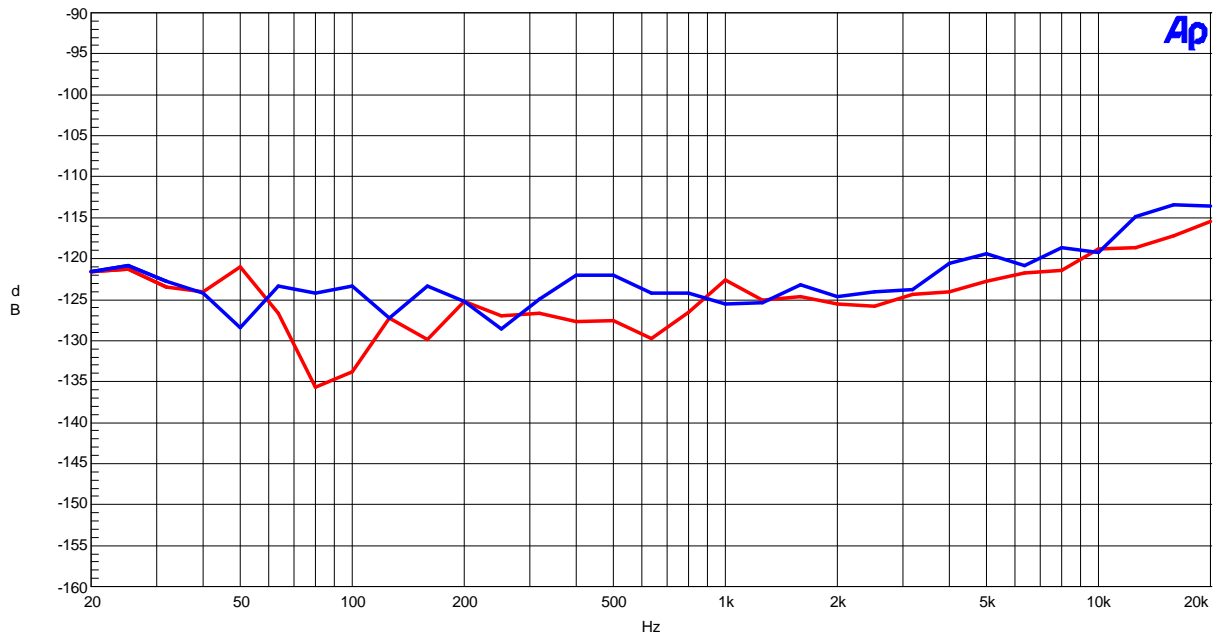

Figure 5. Crosstalk

AKM

AK5385A FFT Plot
AVDD=5.0V, DVDD=3.3V, fs=48kHz, Input=-1.0dB, fin=1kHz

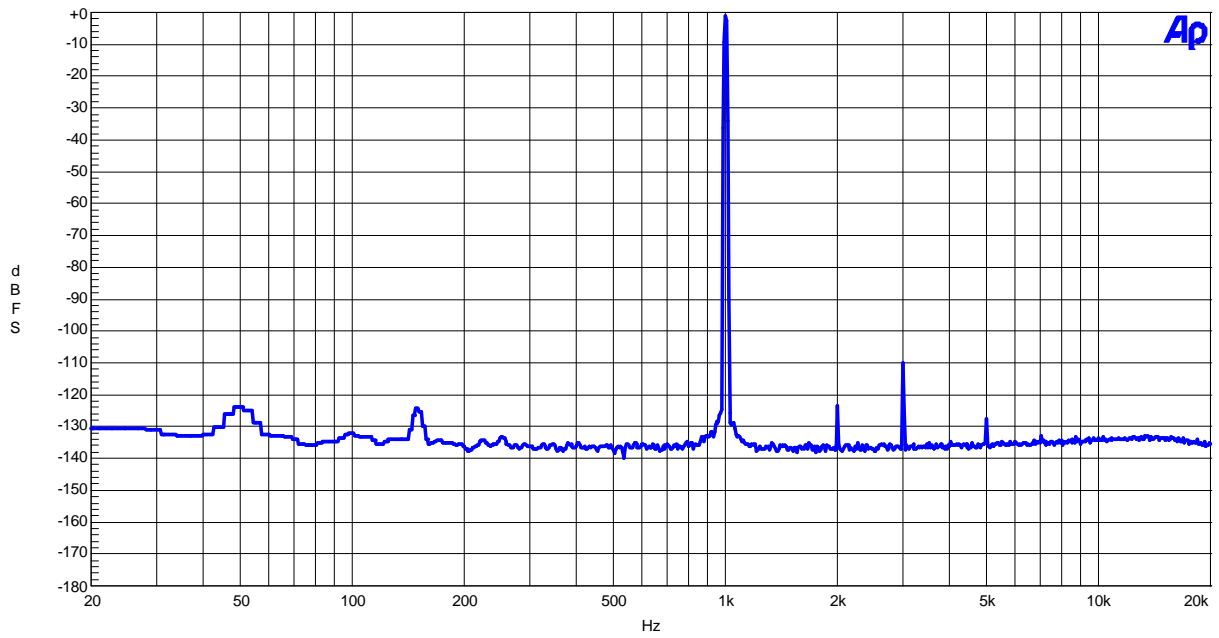

Figure 6. FFT Plot

AKM

AK5385A FFT Plot
AVDD=5.0V, DVDD=3.3V, fs=48kHz, Input=-60dB, fin=1kHz

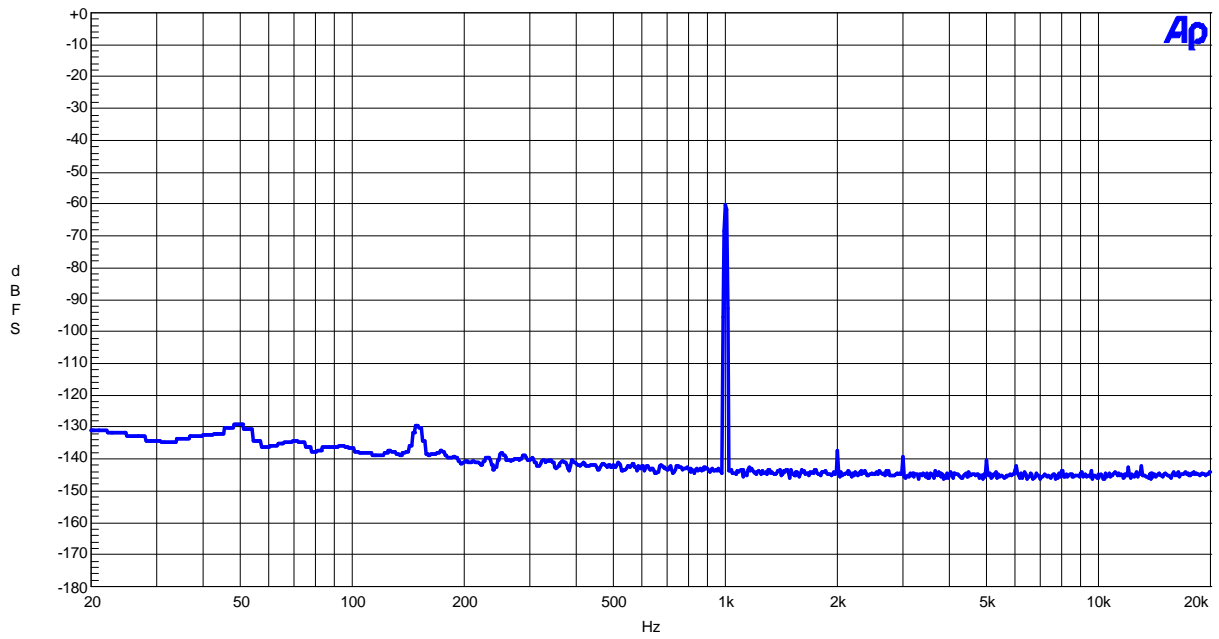

Figure 7. FFT Plot

AKM

AK5385A FFT Plot
AVDD=5.0V, DVDD=3.3V, fs=48kHz, fin=None

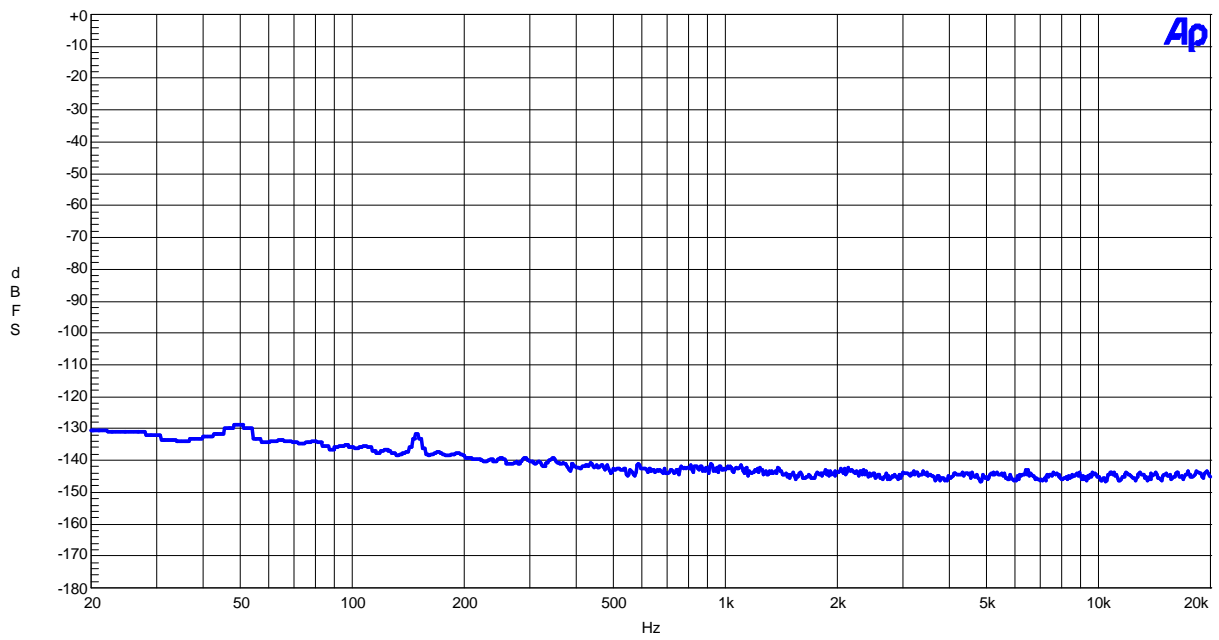

Figure 8. FFT Plot

[ADC Plot : fs=96kHz]

AKM

AK5385A THD+N vs. Input Level
AVDD=5.0V, DVDD=3.3V, fs=96kHz, fin=1kHz

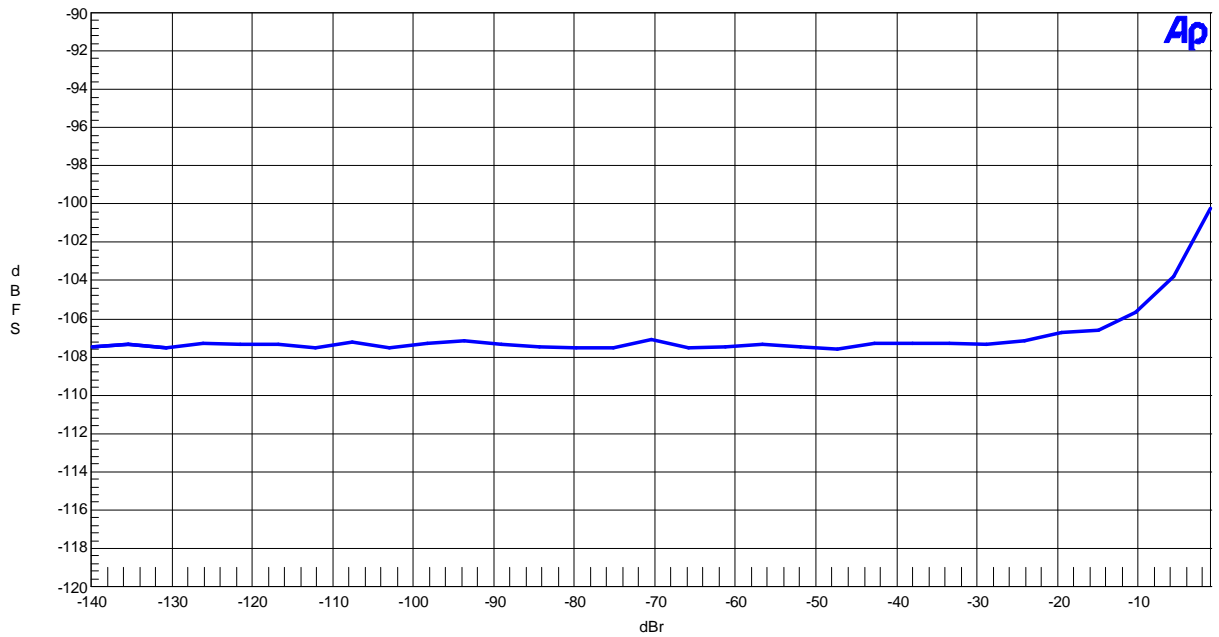

Figure 9. THD+N vs. Input Level

AKM

AK5385A THD+N vs. Input Frequency
AVDD=5.0V, DVDD=3.3V, fs=96kHz, Input=-1.0dBr

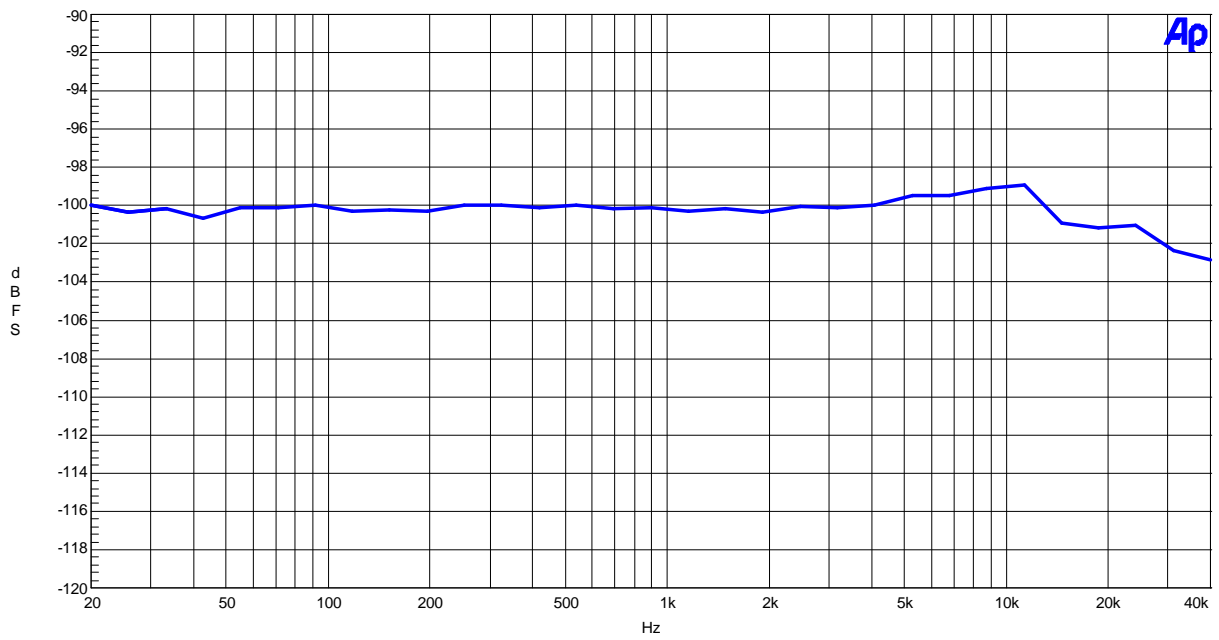

Figure 10. THD+N vs. Input Frequency

AKM

AK5385A Linearity
AVDD=5.0V, DVDD=3.3V, fs=96kHz, fin=1kHz

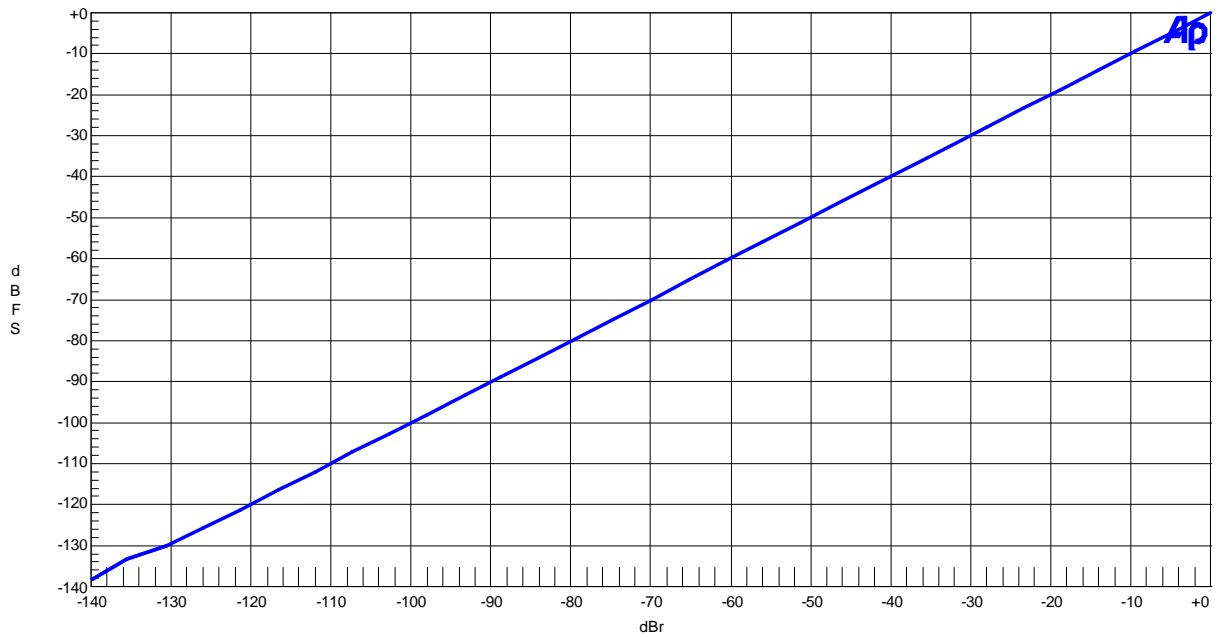

Figure 11. Linearity

AKM

AK5385A Frequency Response
AVDD=5.0V, DVDD=3.3V, fs=96kHz, Input=-1.0dBr

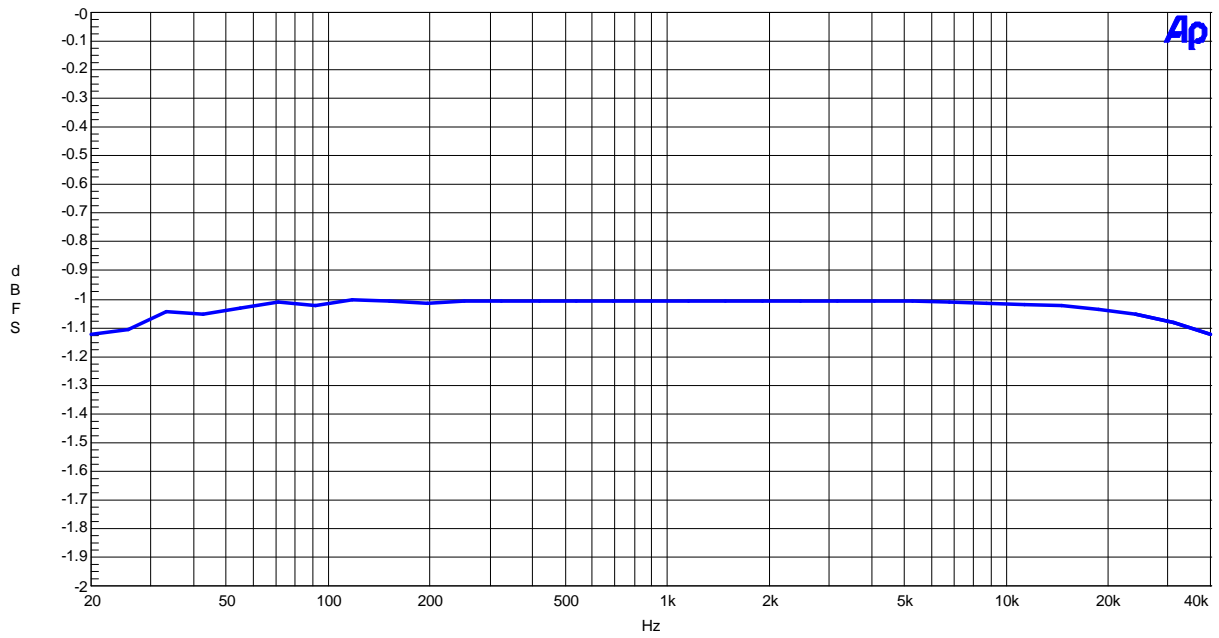

Figure 12. Frequency Response

AKM

AK5385A Crosstalk
AVDD=5.0V, DVDD=3.3V, fs=96kHz, Input=-1.0dB

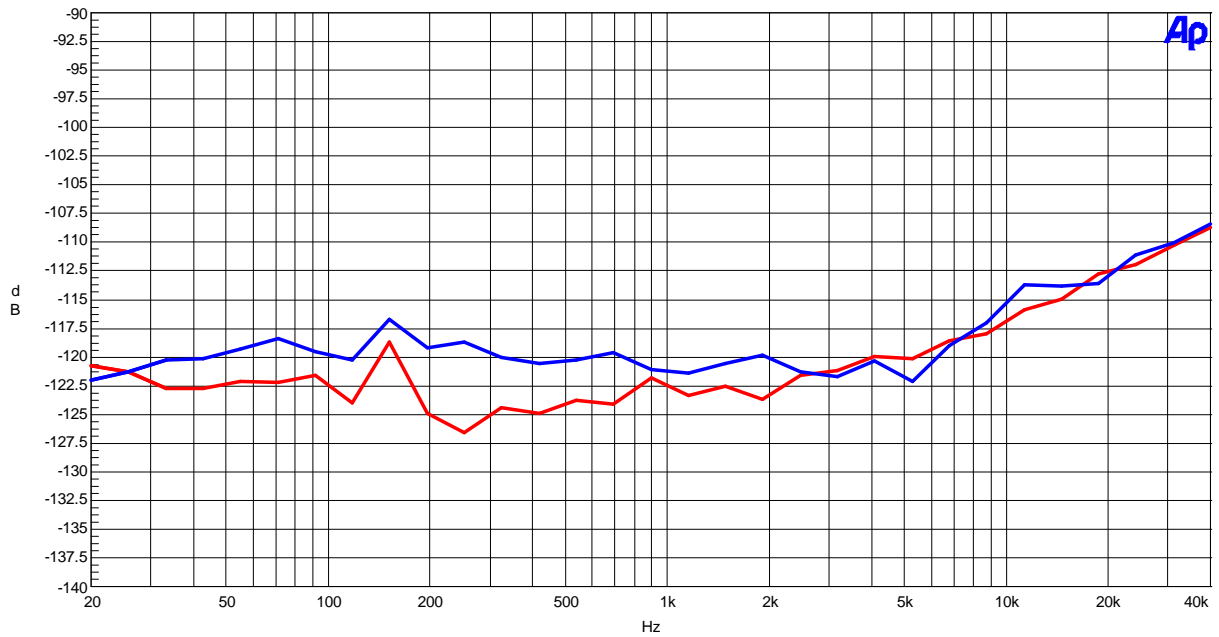

Figure 13. Crosstalk

AKM

AK5385A FFT Plot
AVDD=5.0V, DVDD=3.3V, fs=96kHz, Input=-1.0dB, fin=1kHz

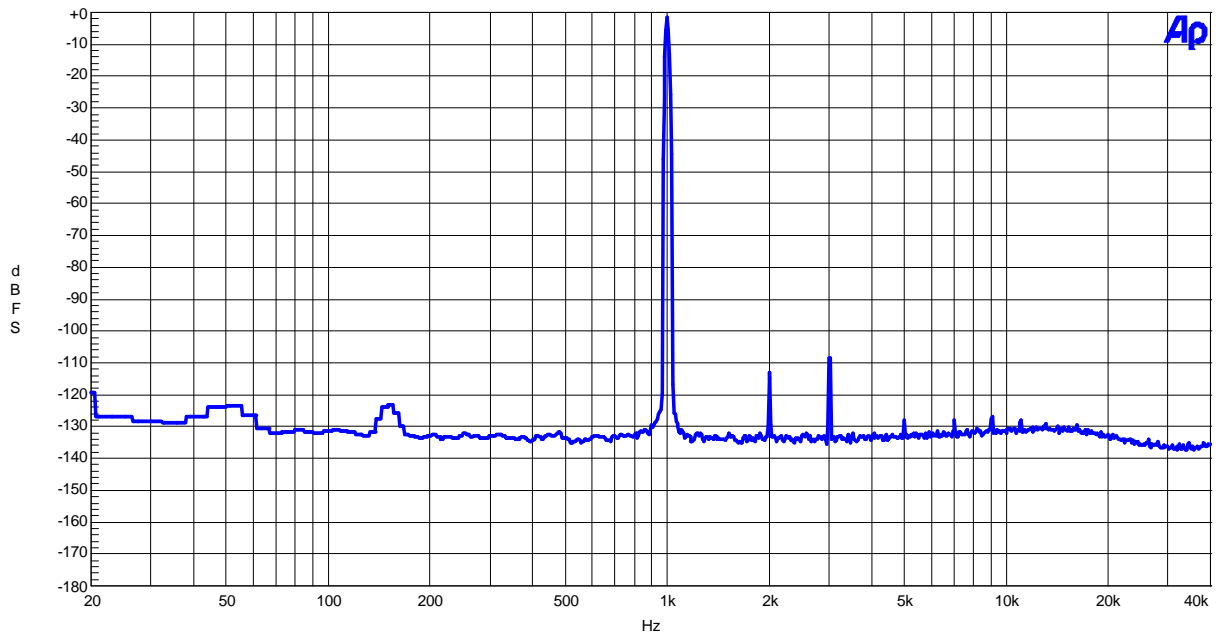

Figure 14. FFT Plot

AKM

AK5385A FFT Plot
AVDD=5.0V, DVDD=3.3V, fs=96kHz, Input=-60dB, fin=1kHz

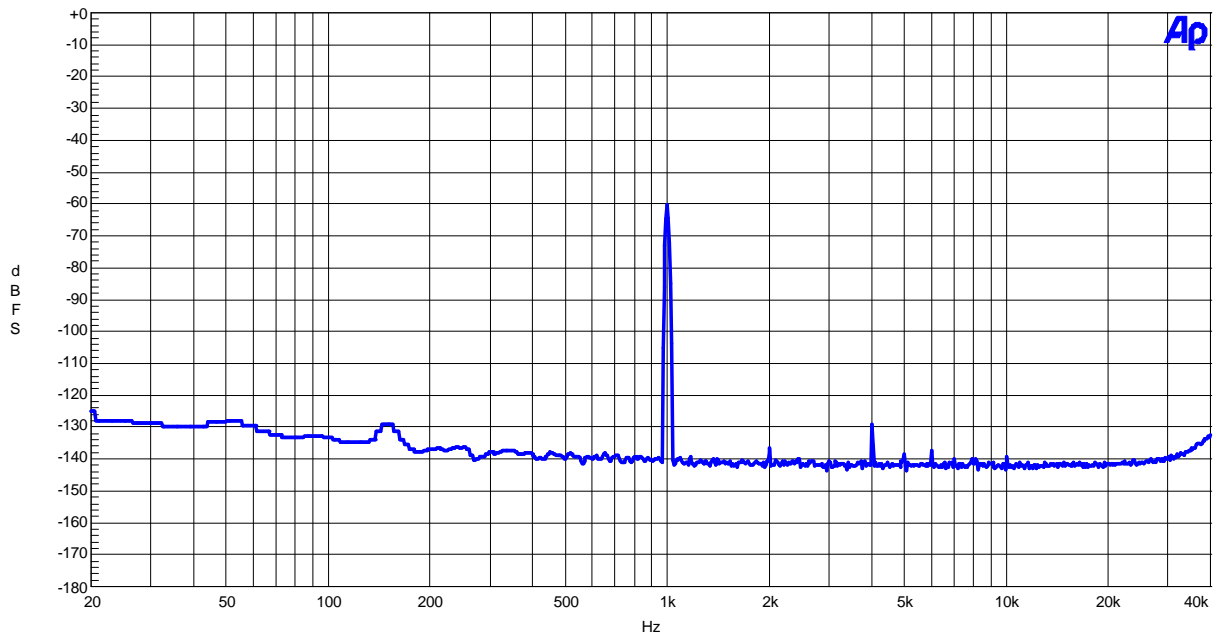

Figure 15. FFT Plot

AKM

AK5385A FFT Plot
AVDD=5.0V, DVDD=3.3V, fs=96kHz, fin=None

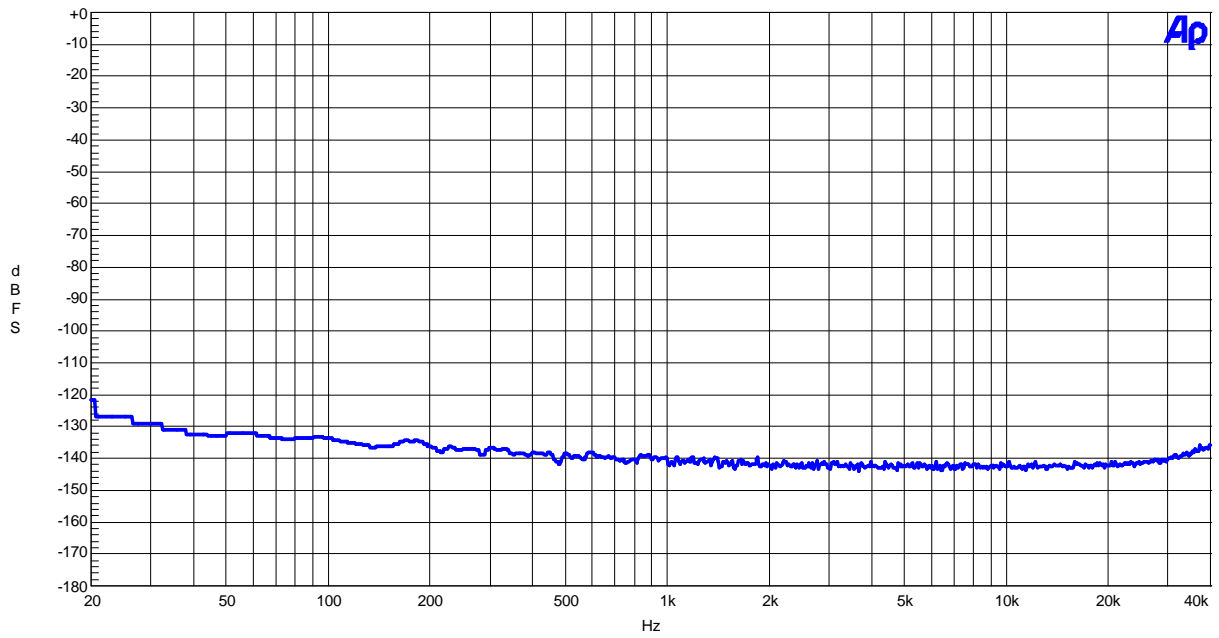

Figure 16. FFT Plot

[ADC Plot : fs=192kHz]

AKM

AK5385A THD+N vs. Input Level
AVDD=5.0V, DVDD=3.3V, fs=192kHz, fin=1kHz

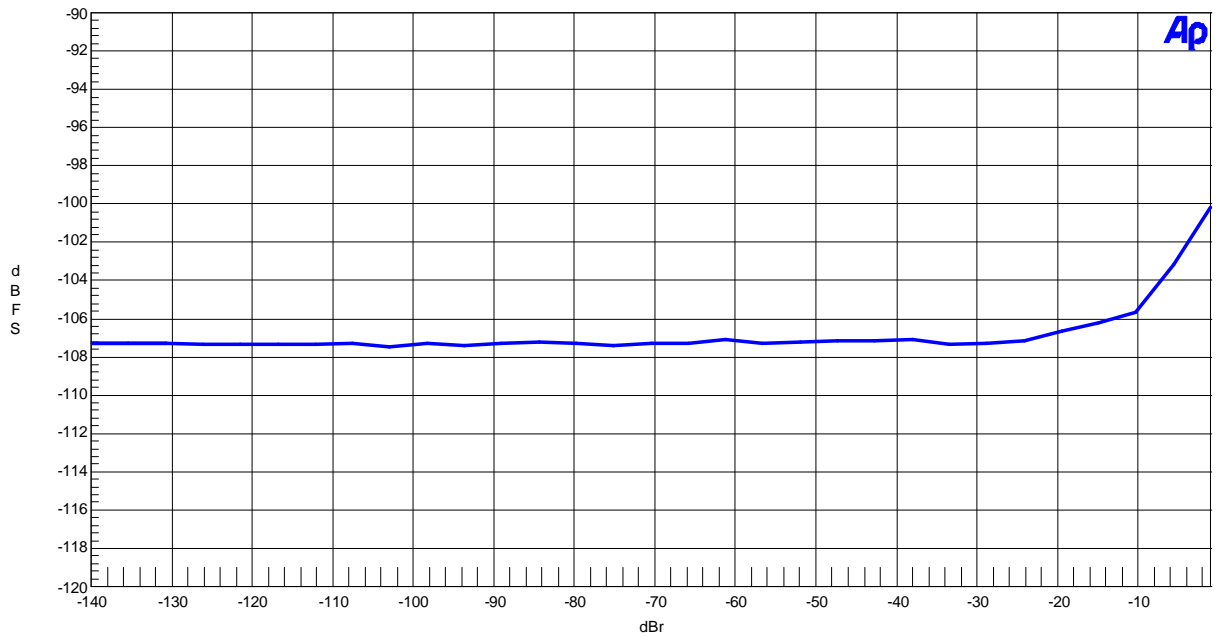

Figure 17. THD+N vs. Input Level

AKM

AK5385A THD+N vs. Input Frequency
AVDD=5.0V, DVDD=3.3V, fs=192kHz, Input=-1.0dBr

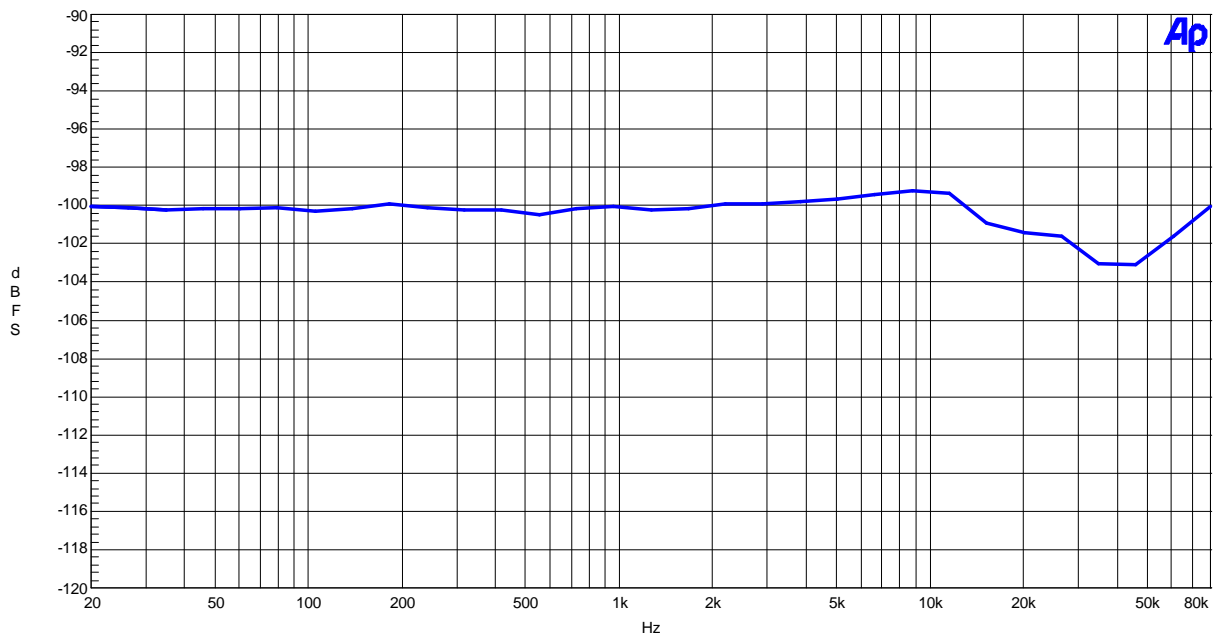

Figure 18. THD+N vs. Input Frequency (BW=40kHz)

AKM

AK5385A Linearity
AVDD=5.0V, DVDD=3.3V, fs=192kHz, fin=1kHz

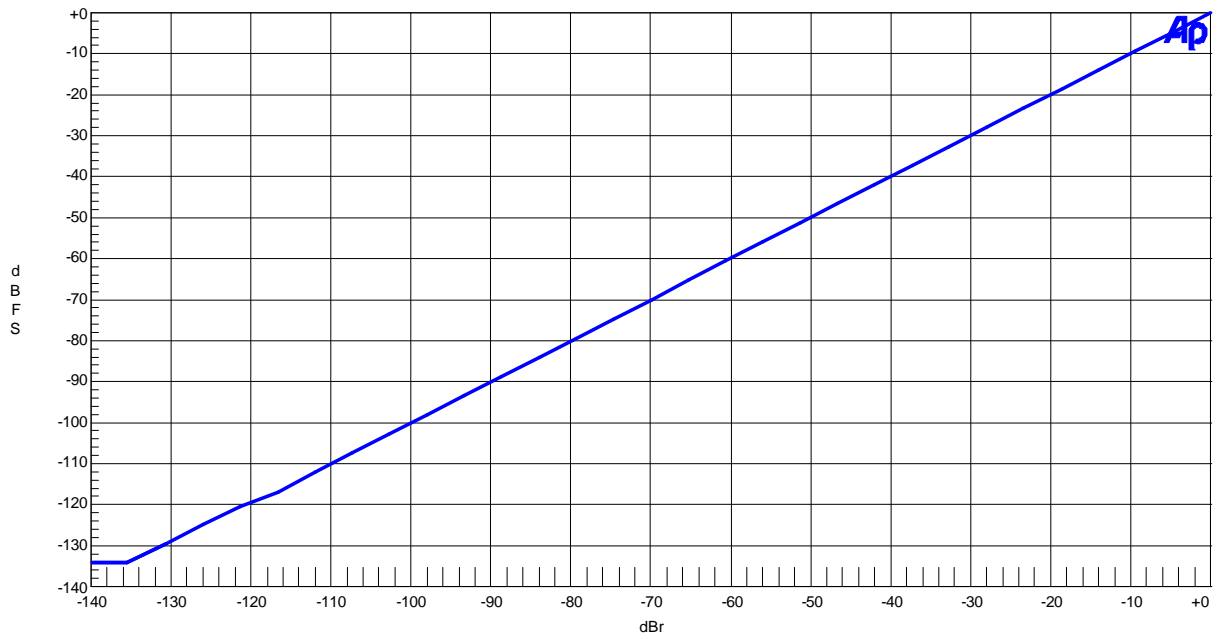

Figure 19. Linearity

AKM

AK5385A Frequency Response
AVDD=5.0V, DVDD=3.3V, fs=192kHz, Input=-1.0dBr

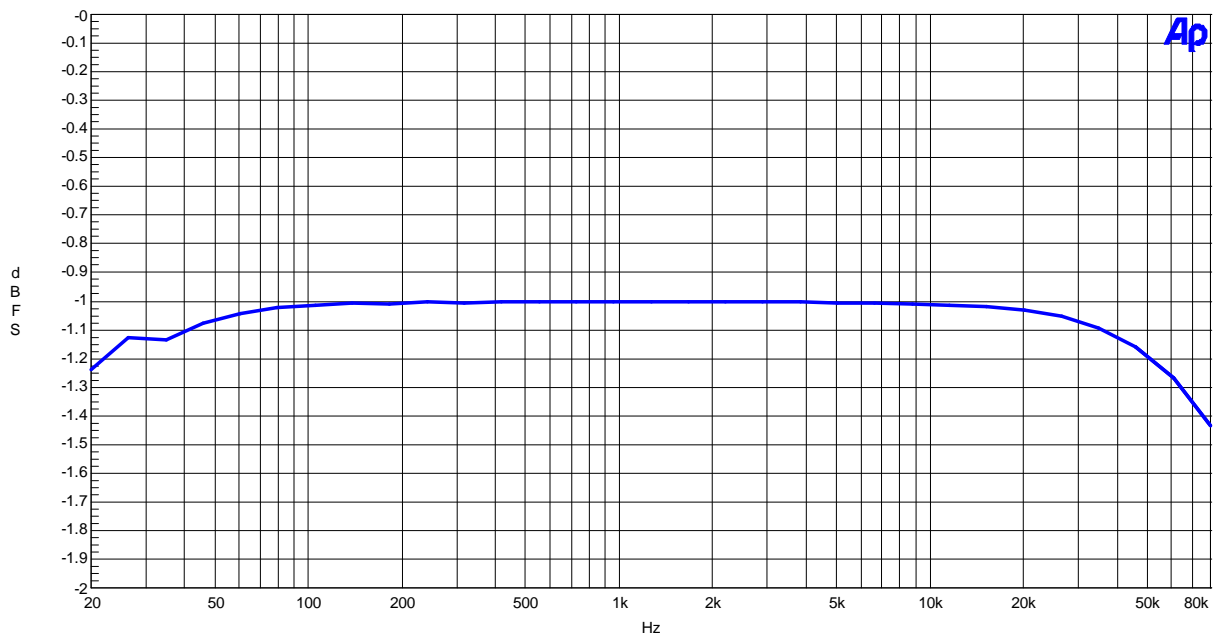

Figure 20. Frequency Response

AKM

AK5385A Crosstalk
AVDD=5.0V, DVDD=3.3V, fs=192kHz, Input=-1.0dB

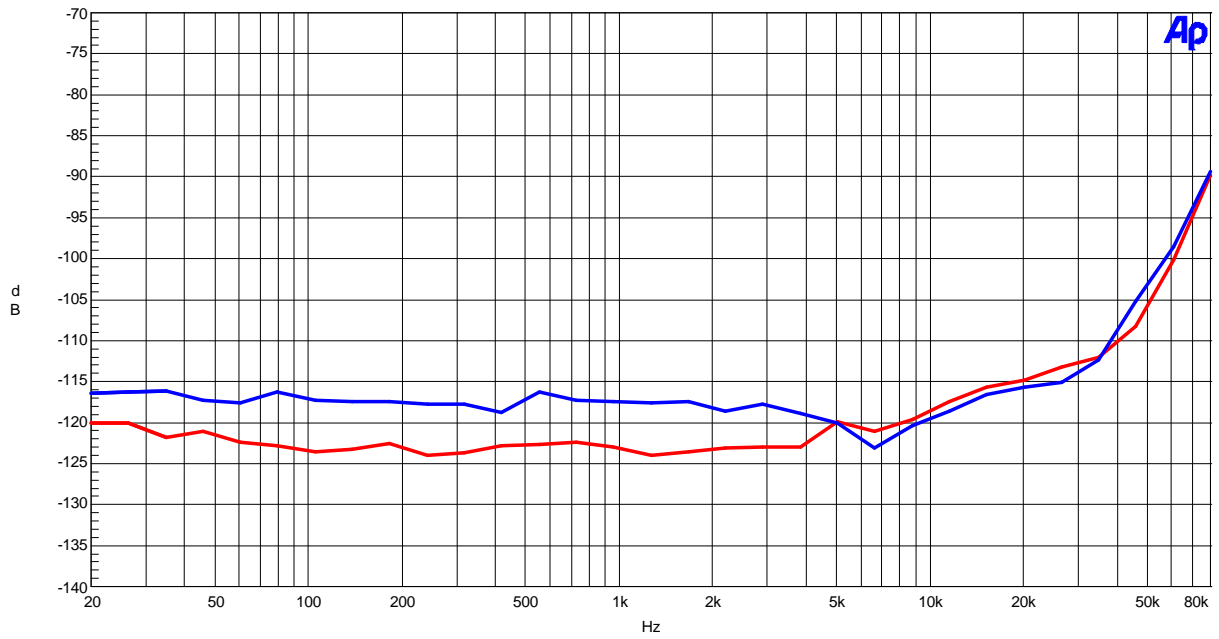

Figure 21. Crosstalk

AKM

AK5385A FFT Plot
AVDD=5.0V, DVDD=3.3V, fs=192kHz, Input=-1.0dB, fin=1kHz

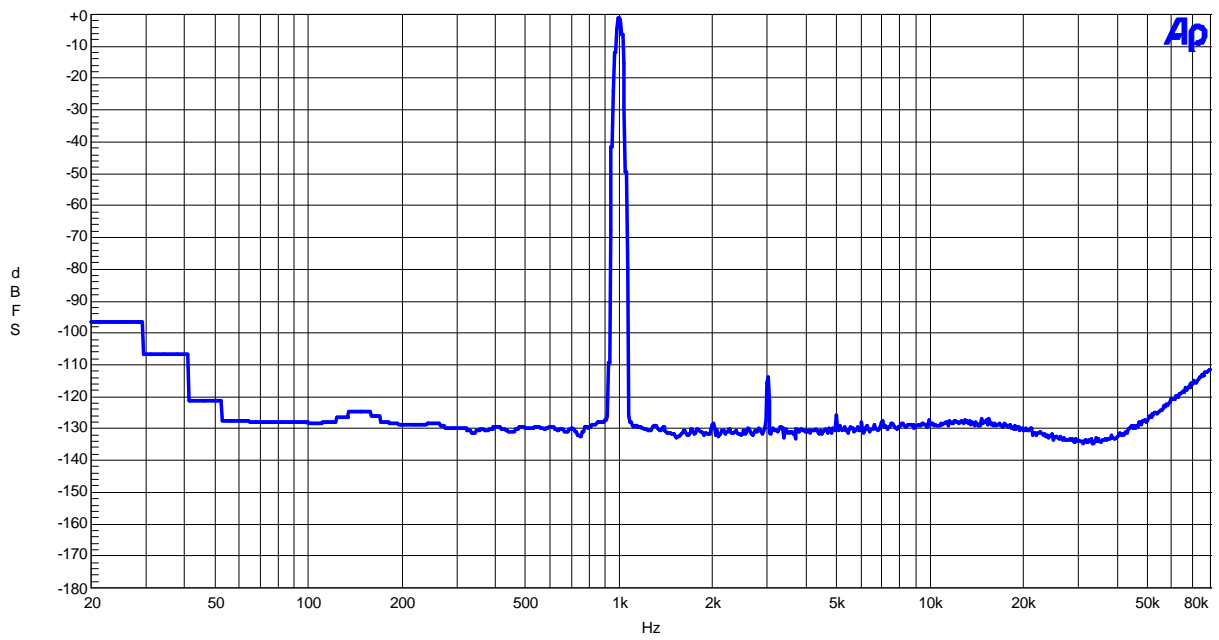

Figure 22. FFT Plot

AKM

AK5385A FFT Plot
AVDD=5.0V, DVDD=3.3V, fs=192kHz, Input=-60dB, fin=1kHz

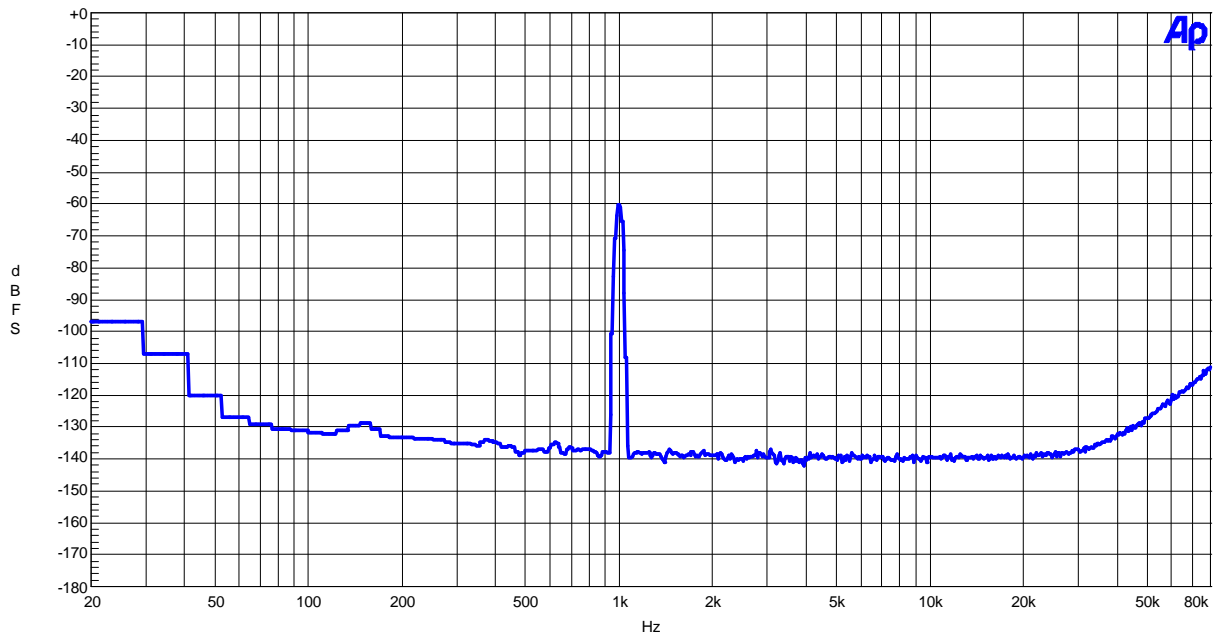

Figure 23. FFT Plot

AKM

AK5385A FFT Plot
AVDD=5.0V, DVDD=3.3V, fs=192kHz, fin=None

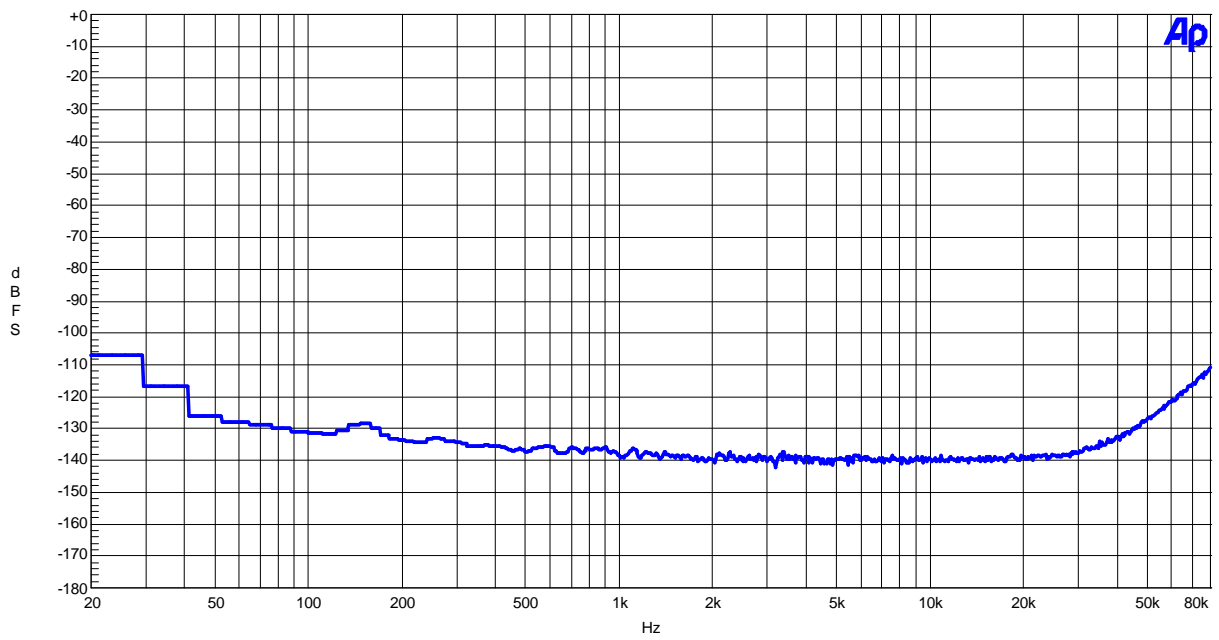
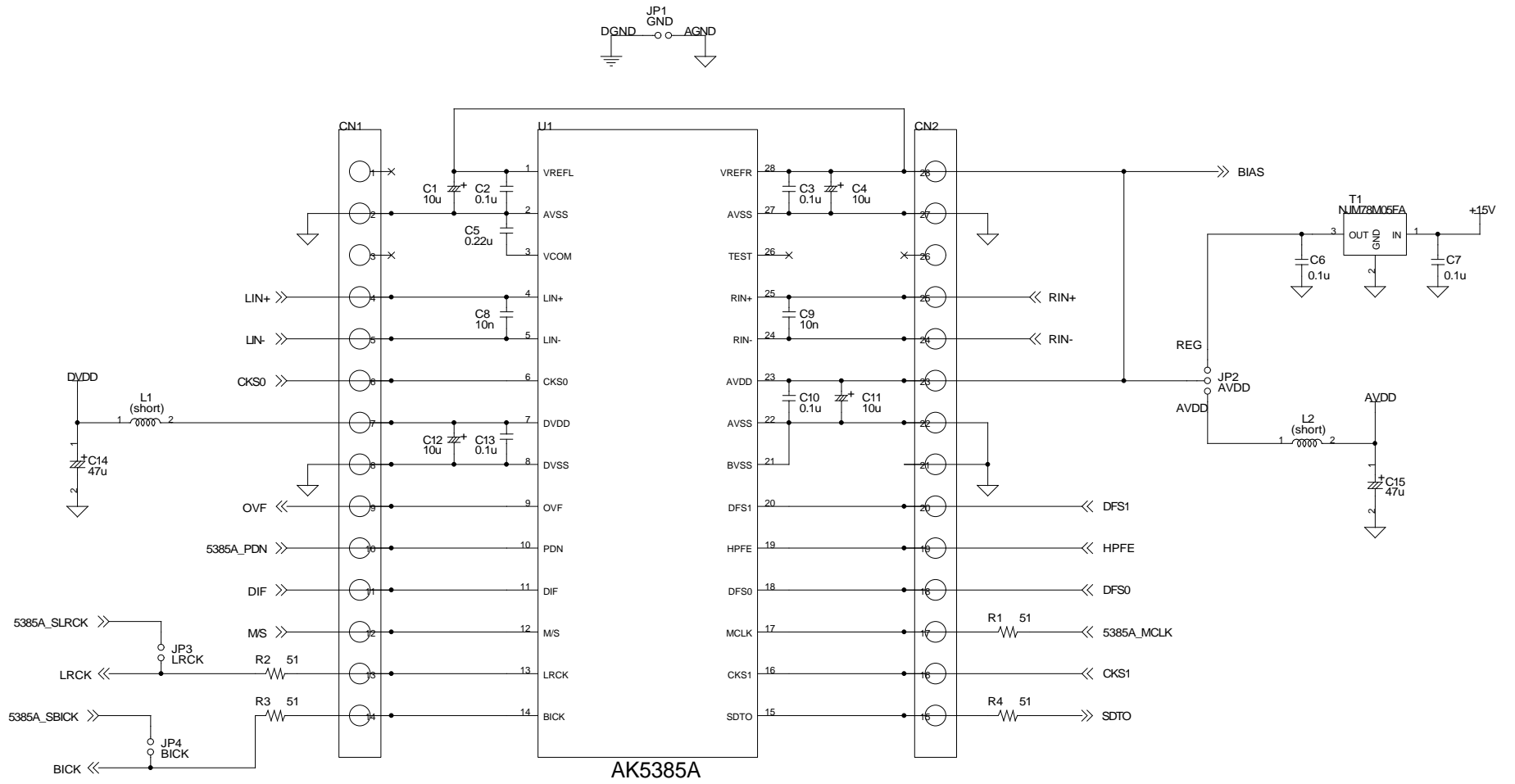

Figure 24. FFT Plot

IMPORTANT NOTICE

- These products and their specifications are subject to change without notice. Before considering any use or application, consult the Asahi Kasei Microsystems Co., Ltd. (AKM) sales office or authorized distributor concerning their current status.
- AKM assumes no liability for infringement of any patent, intellectual property, or other right in the application or use of any information contained herein.
- Any export of these products, or devices or systems containing them, may require an export license or other official approval under the law and regulations of the country of export pertaining to customs and tariffs, currency exchange, or strategic materials.
- AKM products are neither intended nor authorized for use as critical components in any safety, life support, or other hazard related device or system, and AKM assumes no responsibility relating to any such use, except with the express written consent of the Representative Director of AKM. As used here:
 - a. A hazard related device or system is one designed or intended for life support or maintenance of safety or for applications in medicine, aerospace, nuclear energy, or other fields, in which its failure to function or perform may reasonably be expected to result in loss of life or in significant injury or damage to person or property.
 - b. A critical component is one whose failure to function or perform may reasonably be expected to result, whether directly or indirectly, in the loss of the safety or effectiveness of the device or system containing it, and which must therefore meet very high standards of performance and reliability.
- It is the responsibility of the buyer or distributor of an AKM product who distributes, disposes of, or otherwise places the product with a third party to notify that party in advance of the above content and conditions, and the buyer or distributor agrees to assume any and all responsibility and liability for and hold AKM harmless from any and all claims arising from the use of said product in the absence of such notification.



Title		
AKD5385A		
Size	Document Number	Rev
A3	AK5385A	A
Date:	Thursday, July 10, 2003	Sheet 1 of 4

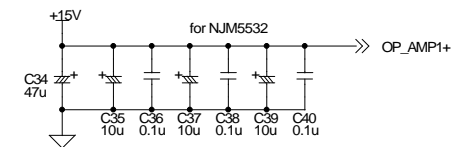
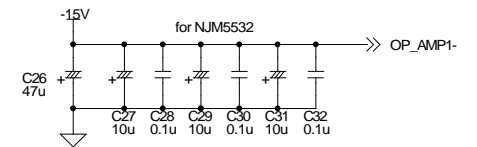
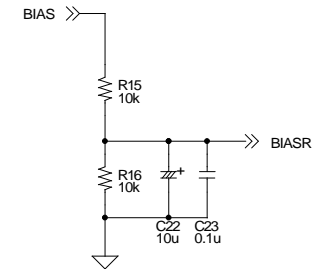
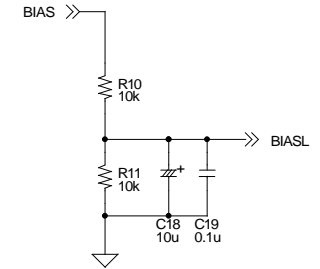
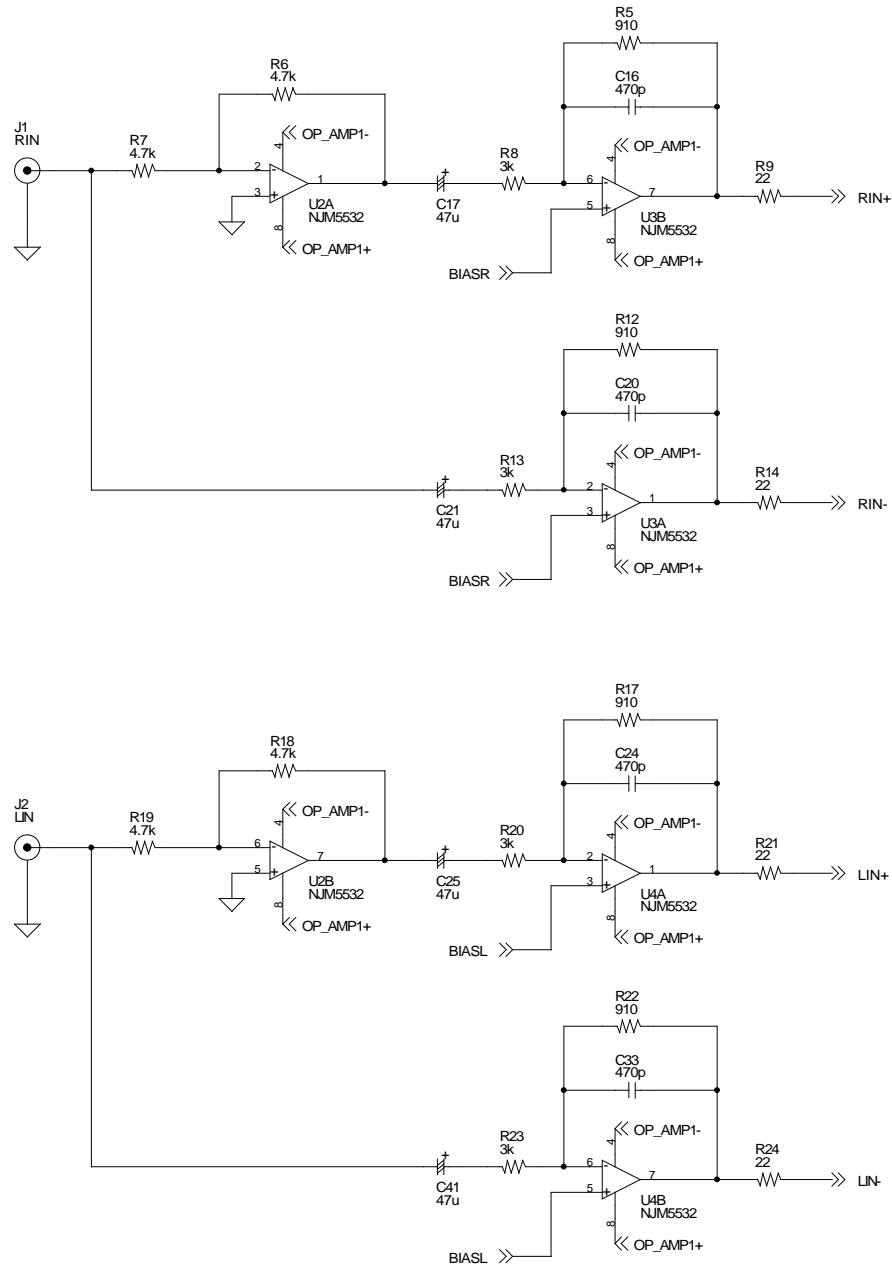

Title			
AKD5385A			
Size	Document Number	Rev	
A3	INPUT	A	
Date:	Thursday, July 10, 2003	Sheet	2 of 4

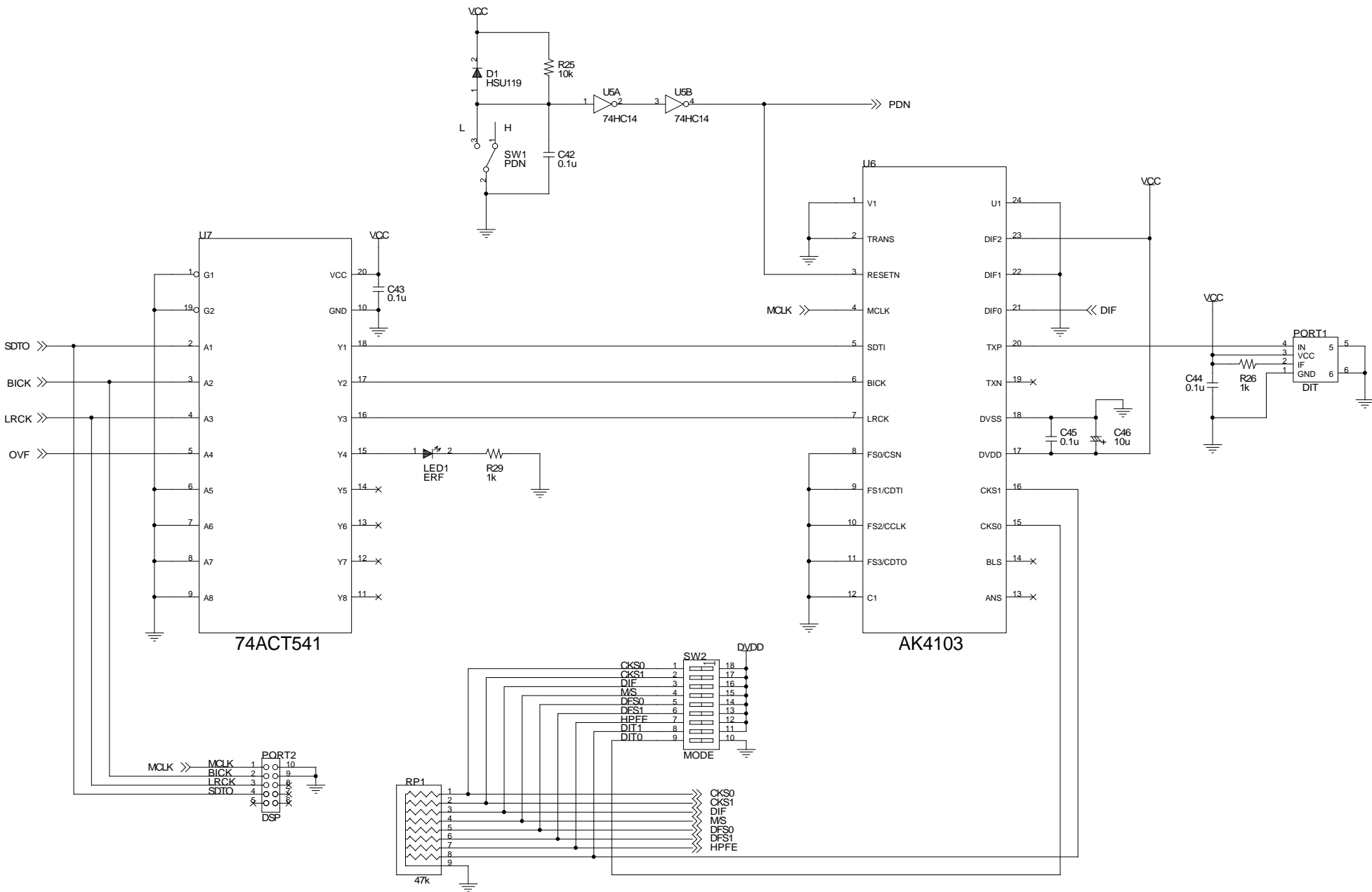

Title		
AKD5385A		
Size	Document Number	Rev
A3	DIT	A
Date:	Thursday, July 10, 2003	Sheet 3 of 4

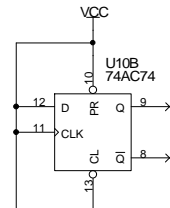
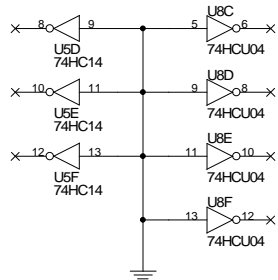
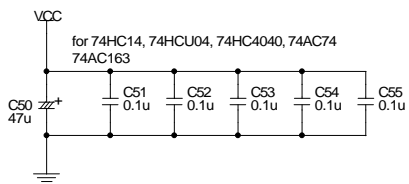
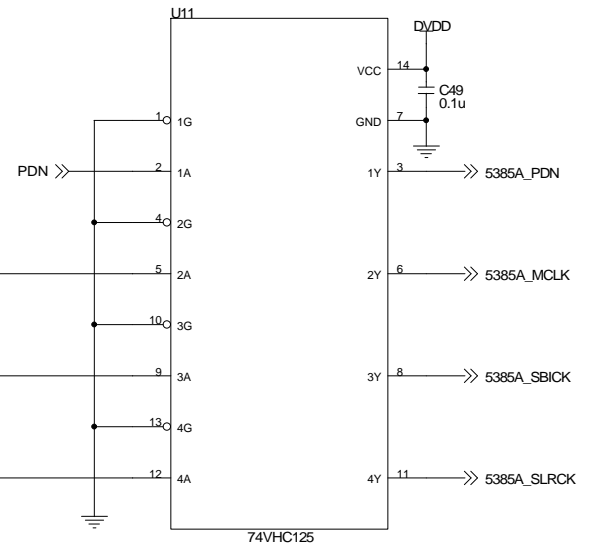
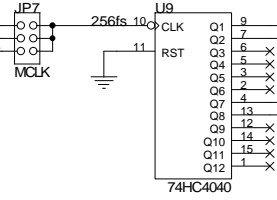
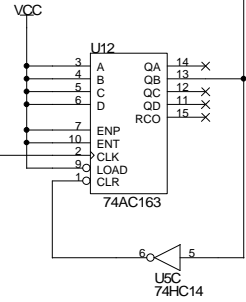
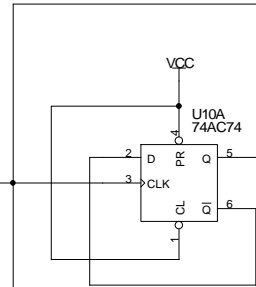
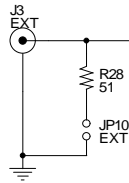
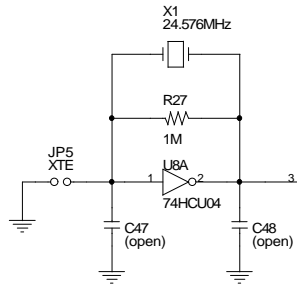

Title			AKD5385A		
Size	Document Number	LOGIC			Rev
A3					A
Date:	Thursday, July 10, 2003	Sheet	4	of	4

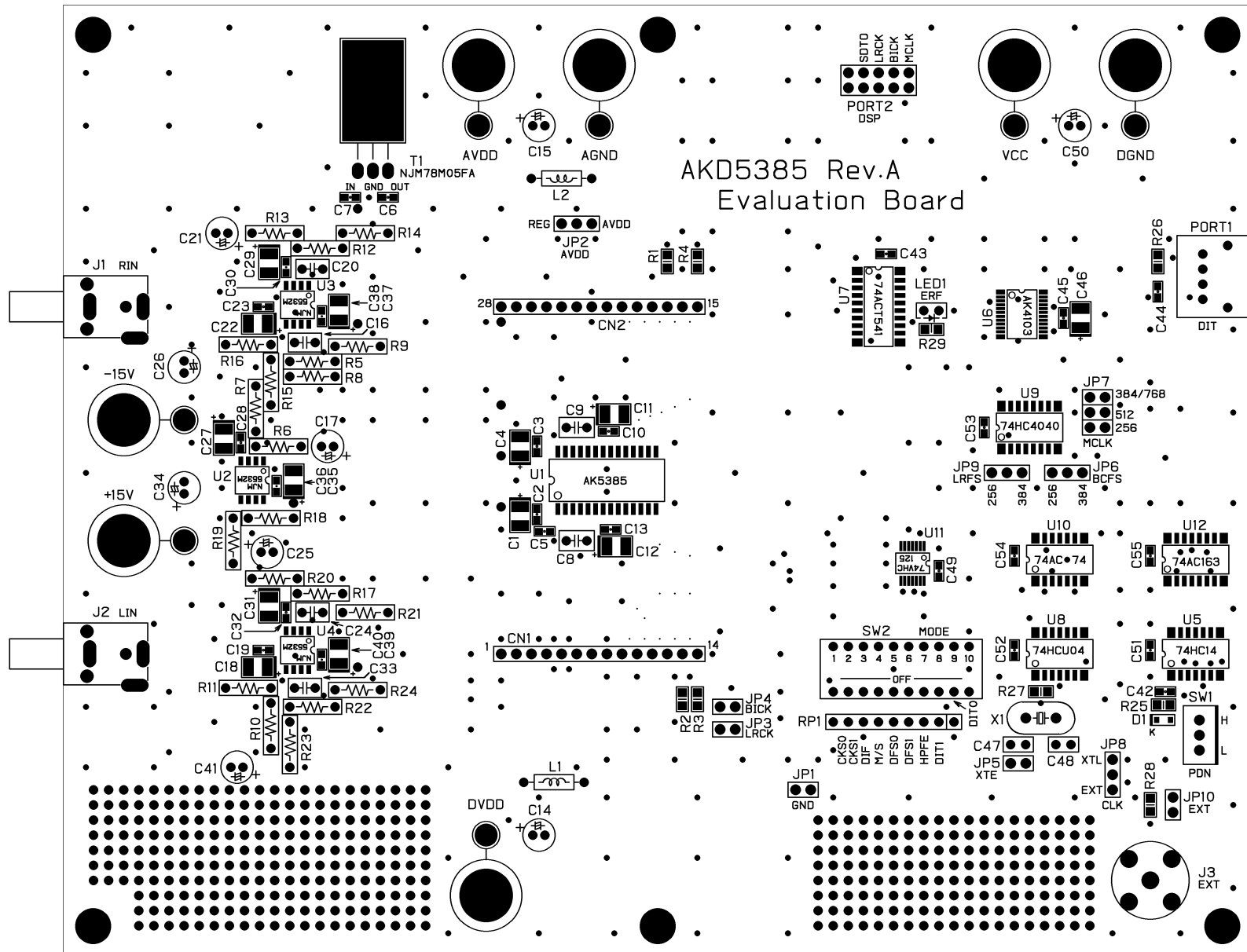

AKD5385 Rev.A
Evaluation Board

AKD5385 Rev.A L1 SR SILK

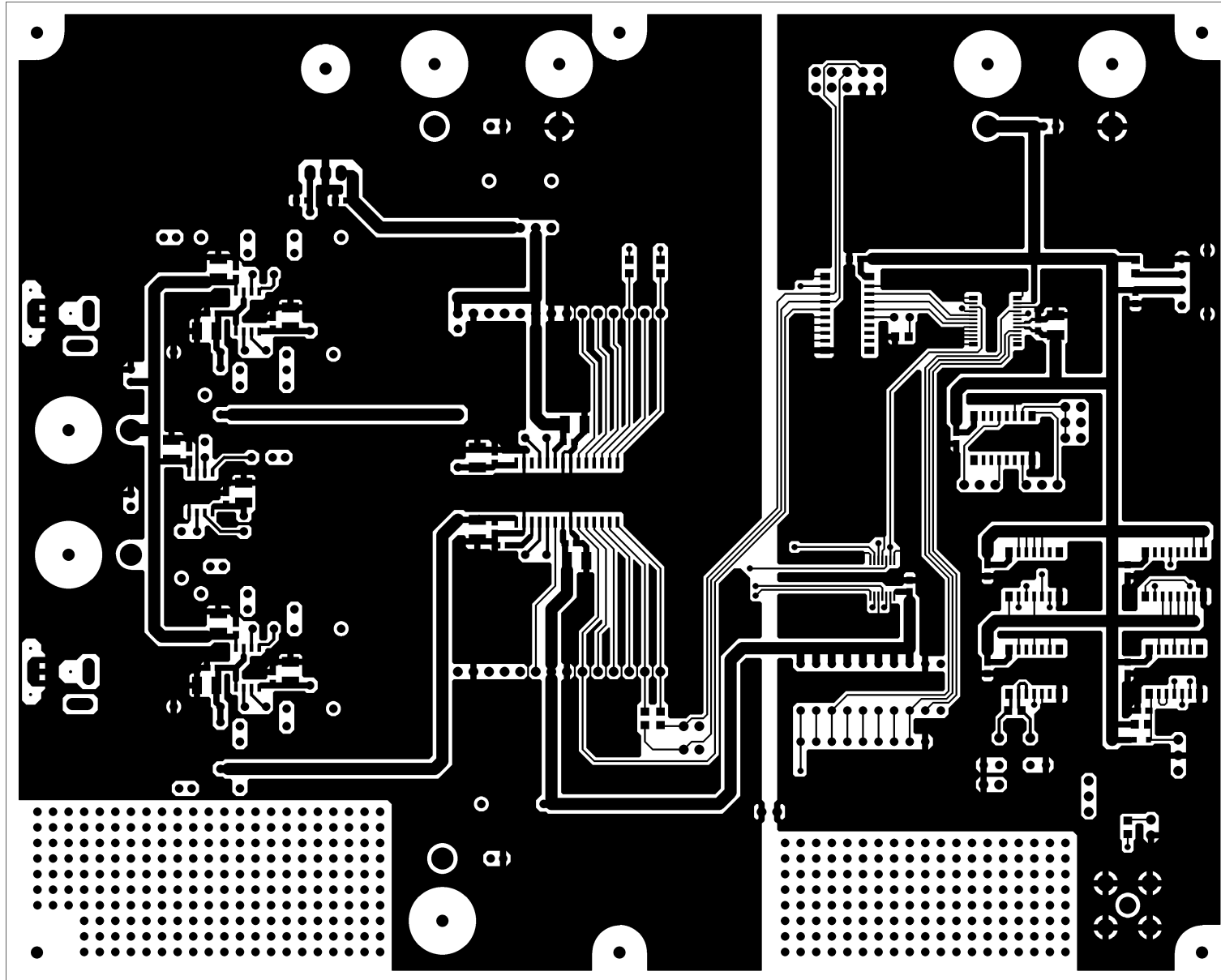

AKD5385 Rev.A L1

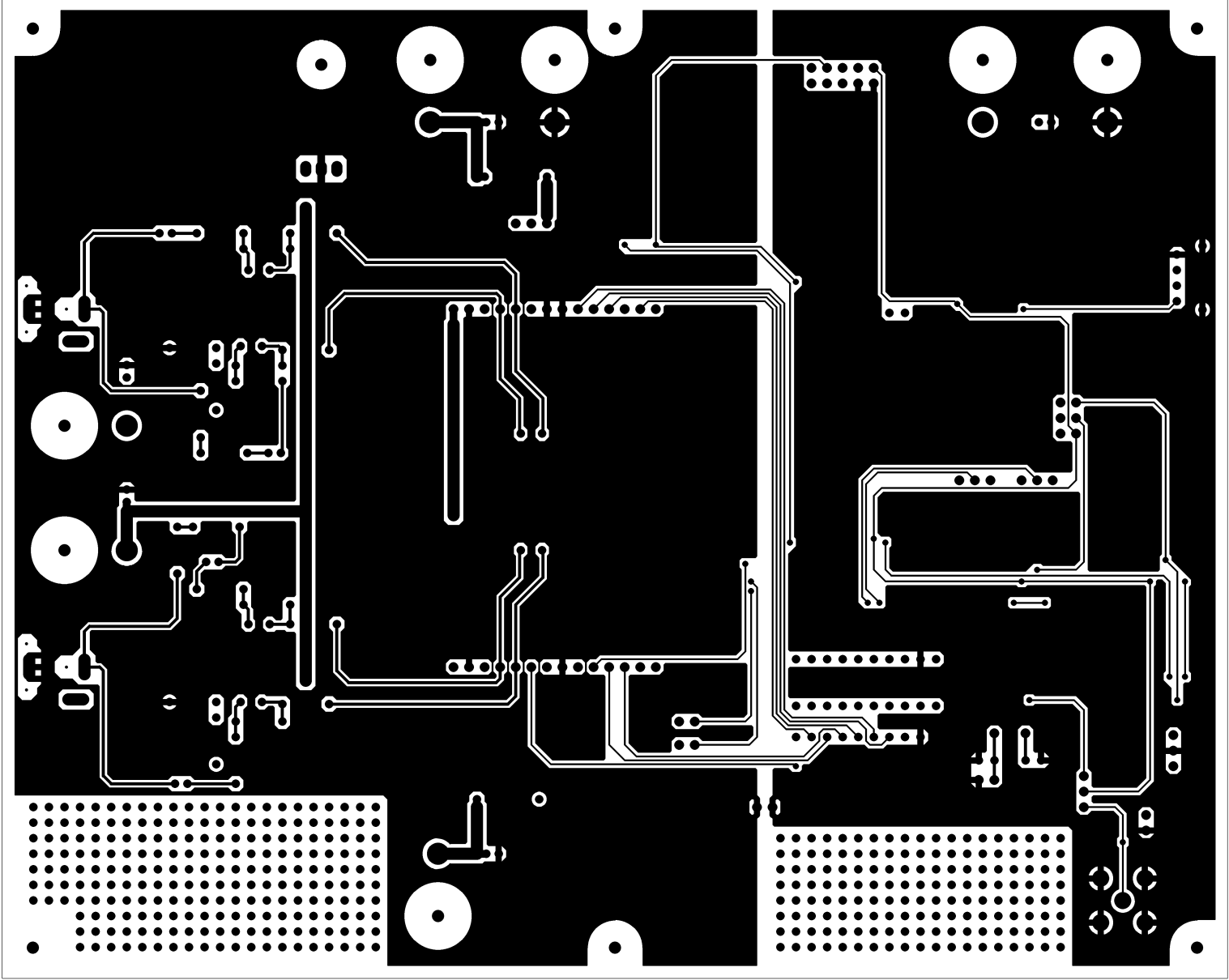

AKD2382 Rev.A LS