

VDSL Quad 4 Band Solution CPE (NT)

APC77174

FEATURES

- Compact single channel, four band VDSL filter solution
- Minimum footprint for maximized port density
- Optimized for use with Infineon PEF22810/14/15 chipset
- Designed for operation to Plan 997 specification



BLOCK DIAGRAM

APC77174

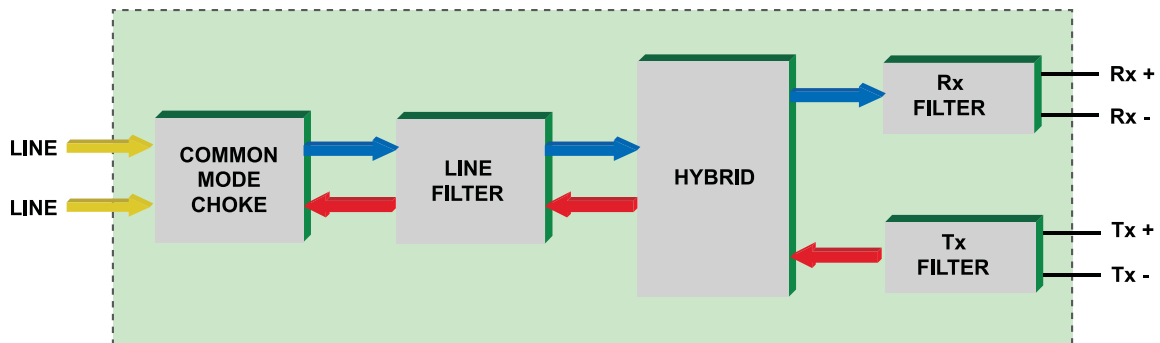

BAND ALLOCATION

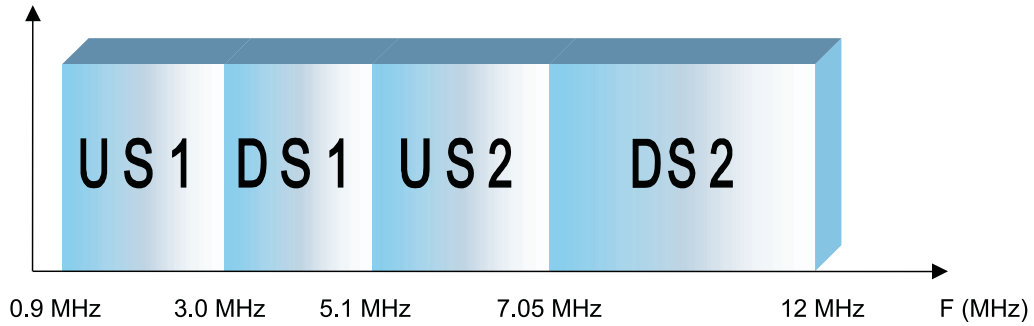

FREQUENCY RESPONSE

The following provisional response has been drawn up from a combination of specifications and simulation. It is an initial aiming point for the design allowing operation down to 900KHz.

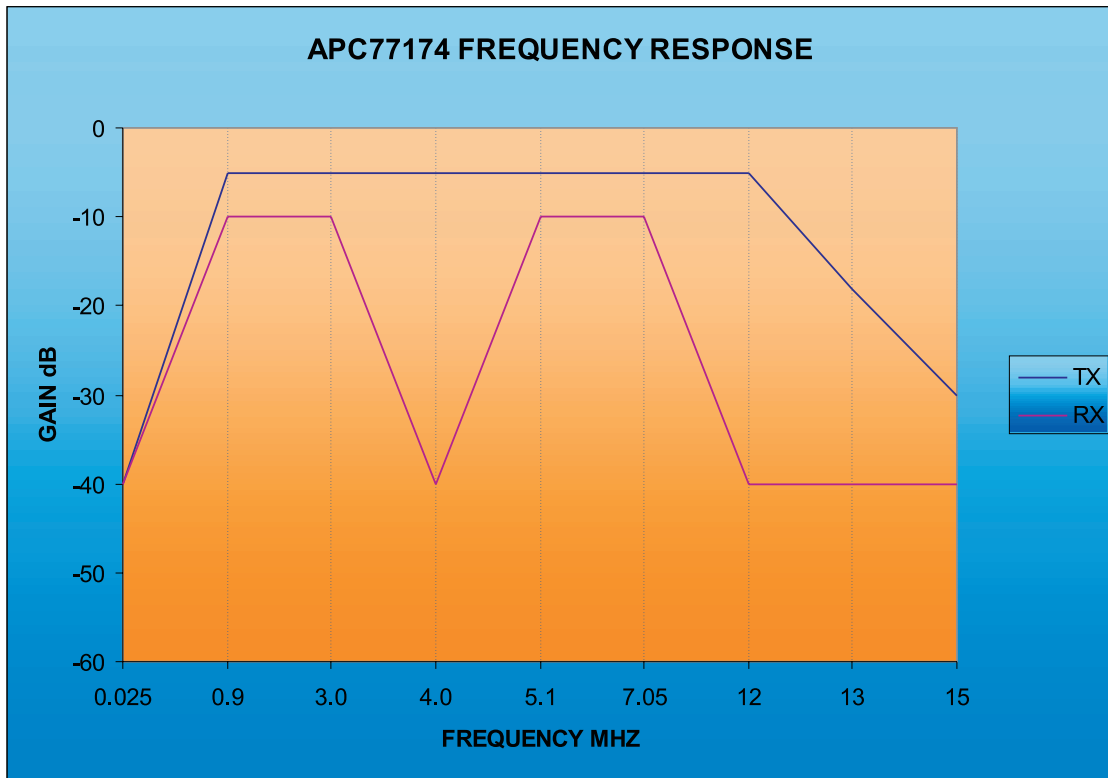

VDSL Quad 4 Band Solution CPE (NT)

APC77174



MECHANICAL

APC77174

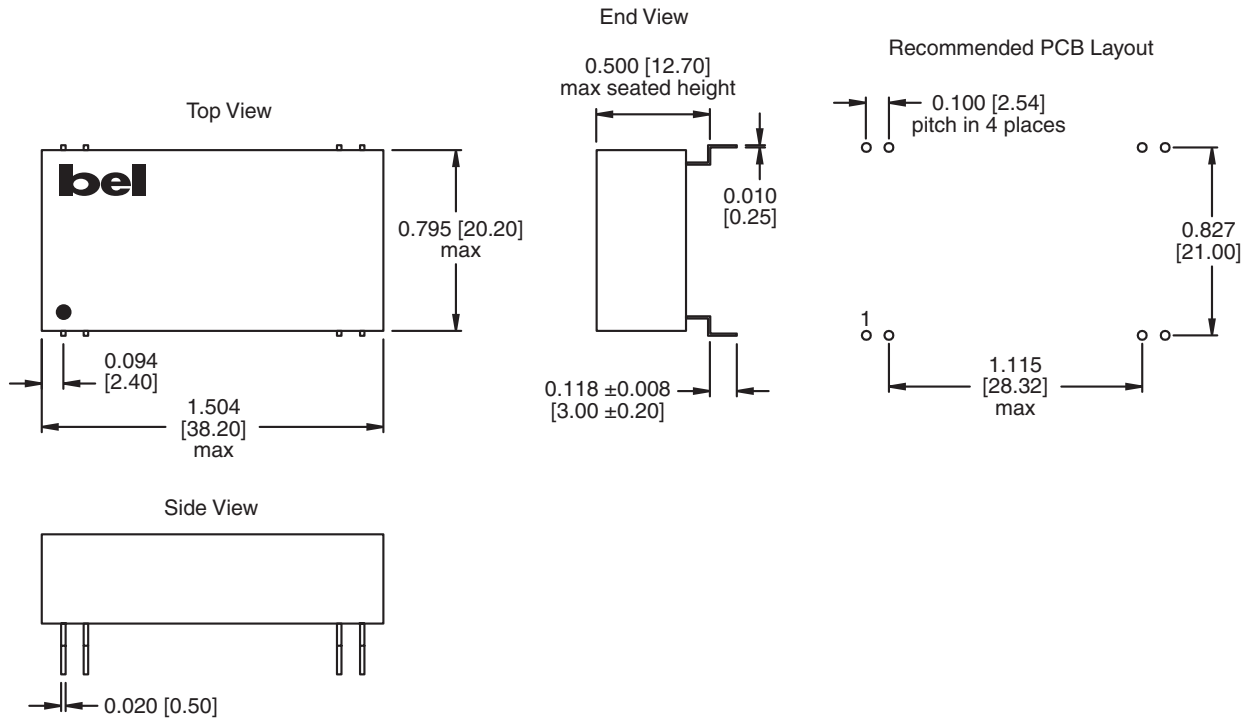

Signal Name	Pin Number
Line+	1
Line-	2
TX+	3
TX-	4
RX+	5
RX-	6
N/C	7 & 8

©2003 Bel Fuse Inc. Specifications subject to change without notice. 09.25.03

CORPORATE

Bel Fuse Inc.
 206 Van Vorst Street
 Jersey City, NJ 07302
 Tel 201-432-0463
 Fax 201-432-9542
 www.belfuse.com

FAR EAST

Bel Fuse Ltd.
 8F / 8 Luk Hop Street
 San Po Kong
 Kowloon, Hong Kong
 Tel 852-2328-5515
 Fax 852-2352-3706
 www.belfuse.com

EUROPE

Bel Stewart Connector
 45/46 Riverside
 Medway City Estate
 Rochester, Kent ME2 4DP U.K.
 Tel 44-1634-722890
 Fax 44-1634-716677
 www.belfuse.com