

APHHS1005MGCK

MEGA GREEN

Features

- 1.0mmX0.5mm SMT LED, 0.5mm THICKNESS.
- LOW POWER CONSUMPTION.
- WIDE VIEWING ANGLE.
- IDEAL FOR BACKLIGHT AND INDICATOR.
- VARIOUS COLORS AND LENS TYPES AVAILABLE.
- PACKAGE: 2000PCS / REEL .
- RoHS COMPLIANT.

Description

The Mega Green source color devices are made with DH InGaAlP on GaAs substrate Light Emitting Diode.

Package Dimensions

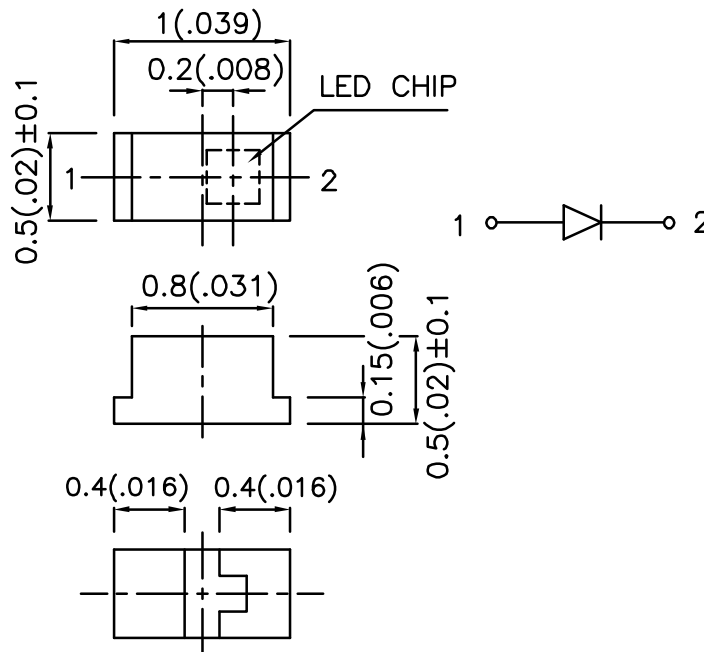

Notes:

1. All dimensions are in millimeters (inches).
2. Tolerance is ±0.1(0.004") unless otherwise noted.
3. Specifications are subject to change without notice.

Selection Guide

Part No.	Dice	Lens Type	Iv (mcd) @ 20mA		Viewing Angle
			Min.	Typ.	θ1/2
APHHS1005MGCK	MEGA GREEN (InGaAlP)	WATER CLEAR	18	45	120°

Note:

1. θ1/2 is the angle from optical centerline where the luminous intensity is 1/2 the optical centerline value.

Electrical / Optical Characteristics at T_A=25°C

Symbol	Parameter	Device	Typ.	Max.	Units	Test Conditions
λ _{peak}	Peak Wavelength	Mega Green	574		nm	I _F =20mA
λ _D	Dominant Wavelength	Mega Green	570		nm	I _F =20mA
Δλ _{1/2}	Spectral Line Half-width	Mega Green	20		nm	I _F =20mA
C	Capacitance	Mega Green	15		pF	V _F =0V;f=1MHz
V _F	Forward Voltage	Mega Green	2.1	2.5	V	I _F =20mA
I _R	Reverse Current	Mega Green		10	uA	V _R = 5V

Absolute Maximum Ratings at T_A=25°C

Parameter	Mega Green	Units
Power dissipation	105	mW
DC Forward Current	30	mA
Peak Forward Current [1]	150	mA
Reverse Voltage	5	V
Operating/Storage Temperature	-40°C To +85°C	

Note:

1. 1/10 Duty Cycle, 0.1ms Pulse Width.

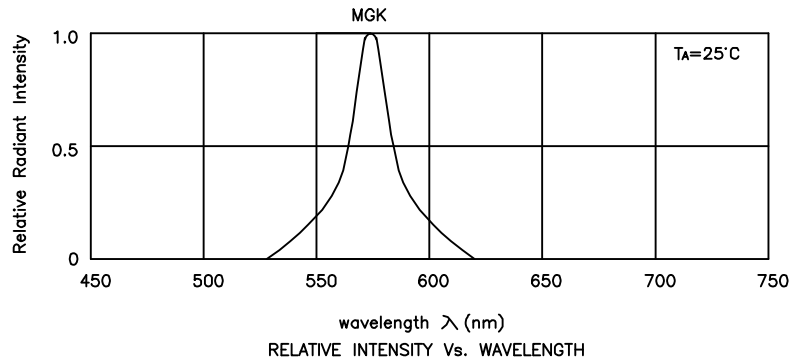

Mega Green

APHHS1005MGCK

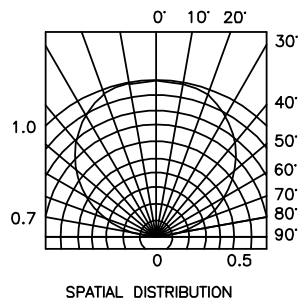
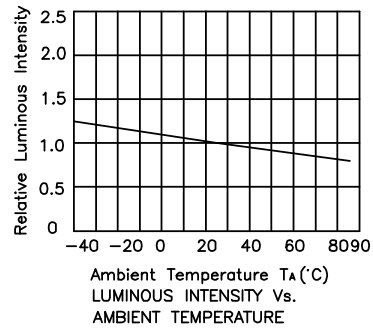
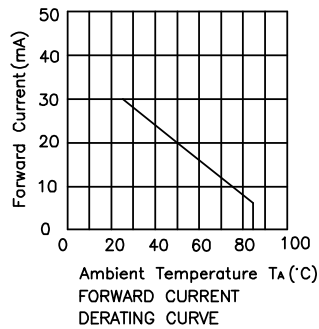
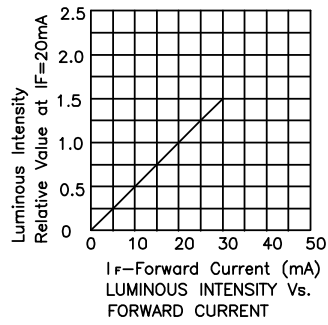
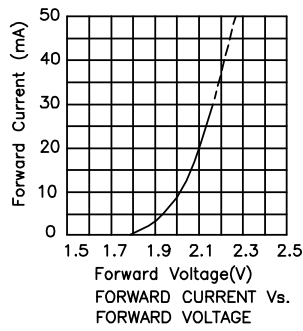

APHHS1005MGCK

Reflow Soldering Profile For Lead-free SMT Process.

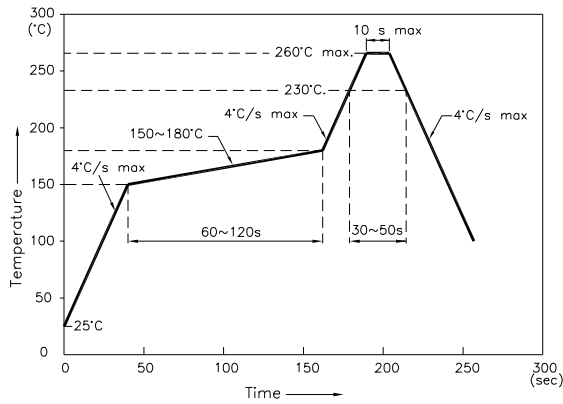

NOTES:

1. We recommend the reflow temperature 245°C(+/-5°C). The maximum soldering temperature should be limited to 260°C.
2. Don't cause stress to the epoxy resin while it is exposed to high temperature.
3. Number of reflow process shall be 2 times or less.

Recommended Soldering Pattern (Units : mm)

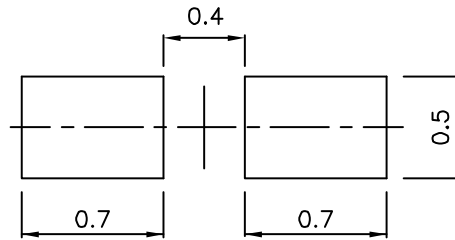

Tape Specifications (Units : mm)

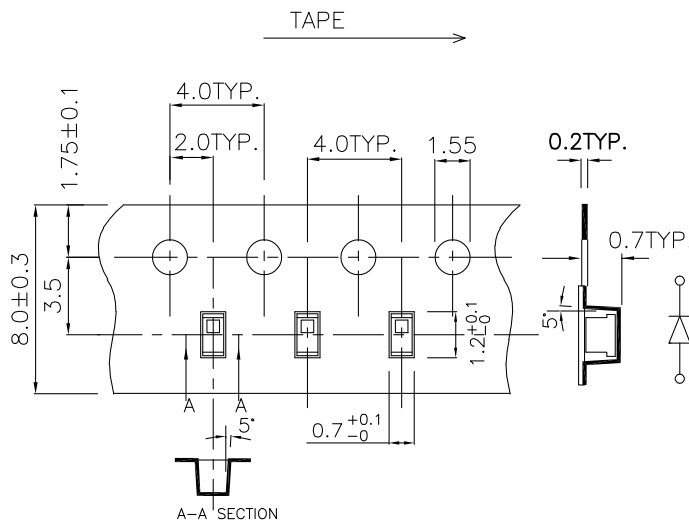

Remarks:

If there is sorting requirement (eg. forward voltage, luminous intensity or wavelength) , the condition as follows:

1. Wavelength: +/-1nm (Test condition is based on the sorting standard).
2. Luminous intensity: +/-15% (Test condition is based on the sorting standard).
3. Forward voltage: +/-0.1V (Test condition is based on the sorting standard).