

Part Number: APHHS1005PBC/A

Blue



**ATTENTION**  
OBSERVE PRECAUTIONS  
FOR HANDLING  
ELECTROSTATIC  
DISCHARGE  
SENSITIVE  
DEVICES

### Features

- 1.0mmX0.5mm SMT LED, 0.5mm THICKNESS.
- LOW POWER CONSUMPTION.
- WIDE VIEWING ANGLE.
- IDEAL FOR BACKLIGHT AND INDICATOR.
- VARIOUS COLORS AND LENS TYPES AVAILABLE.
- PACKAGE: 2000PCS / REEL .
- MOISTURE SENSITIVITY LEVEL : LEVEL 3.
- RoHS COMPLIANT.

### Description

The Blue source color devices are made with InGaN on SiC Light Emitting Diode.

Static electricity and surge damage the LEDs.

It is recommended to use a wrist band or anti-electrostatic glove when handling the LEDs.

All devices, equipment and machinery must be electrically grounded.

### Package Dimensions

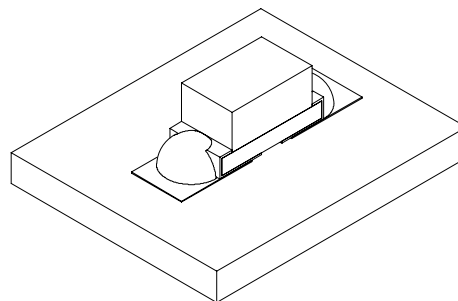
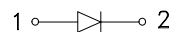
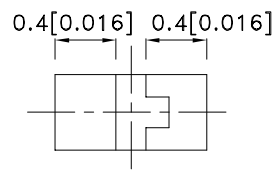
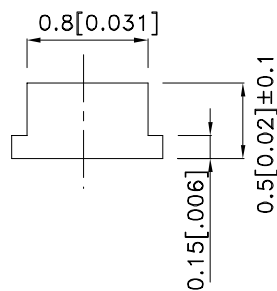
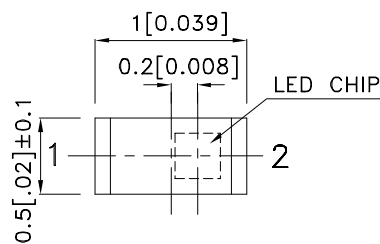

#### Notes:

1. All dimensions are in millimeters (inches).
2. Tolerance is  $\pm 0.1$  (0.004") unless otherwise noted.
3. Specifications are subject to change without notice.
4. The device has a single mounting surface. The device must be mounted according to the specifications.



## Selection Guide

| Part No.       | Dice         | Lens Type   | Iv (mcd) [2]<br>@ 20mA |      | Viewing<br>Angle [1] |
|----------------|--------------|-------------|------------------------|------|----------------------|
|                |              |             | Min.                   | Typ. | 2θ1/2                |
| APHHS1005PBC/A | Blue (InGaN) | WATER CLEAR | 18                     | 60   | 120°                 |

Notes:

1. θ1/2 is the angle from optical centerline where the luminous intensity is 1/2 the optical centerline value.
2. Luminous intensity/ luminous Flux: +/-15%.

## Electrical / Optical Characteristics at TA=25°C

| Symbol             | Parameter                | Device | Typ. | Max. | Units | Test Conditions           |
|--------------------|--------------------------|--------|------|------|-------|---------------------------|
| λ <sub>peak</sub>  | Peak Wavelength          | Blue   | 468  |      | nm    | I <sub>F</sub> =20mA      |
| λ <sub>D</sub> [1] | Dominant Wavelength      | Blue   | 470  |      | nm    | I <sub>F</sub> =20mA      |
| Δλ <sub>1/2</sub>  | Spectral Line Half-width | Blue   | 21   |      | nm    | I <sub>F</sub> =20mA      |
| C                  | Capacitance              | Blue   | 100  |      | pF    | V <sub>F</sub> =0V;f=1MHz |
| V <sub>F</sub> [2] | Forward Voltage          | Blue   | 3.2  | 4    | V     | I <sub>F</sub> =20mA      |
| I <sub>R</sub>     | Reverse Current          | Blue   |      | 10   | uA    | V <sub>R</sub> =5V        |

Notes:

1. Wavelength: +/-1nm.
2. Forward Voltage: +/-0.1V.

## Absolute Maximum Ratings at TA=25°C

| Parameter                | Blue           | Units |
|--------------------------|----------------|-------|
| Power dissipation        | 120            | mW    |
| DC Forward Current       | 30             | mA    |
| Peak Forward Current [1] | 100            | mA    |
| Reverse Voltage          | 5              | V     |
| Operating Temperature    | -40°C To +85°C |       |
| Storage Temperature      | -40°C To +85°C |       |

Note:

1. 1/10 Duty Cycle, 0.1ms Pulse Width.

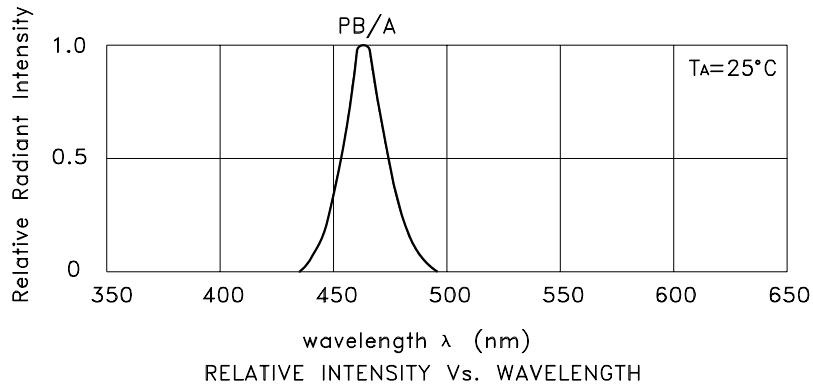

**Blue**

**APHHS1005PBC/A**

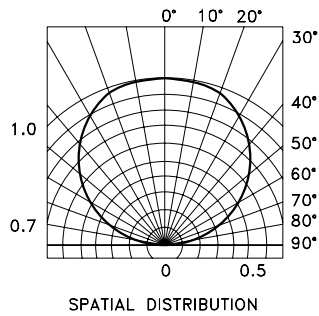
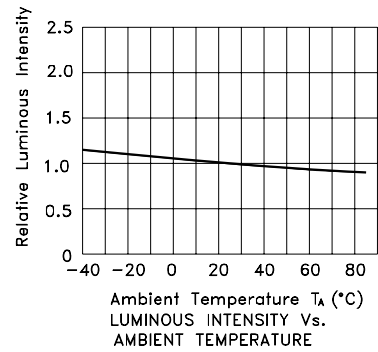
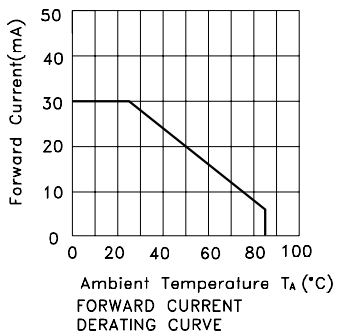
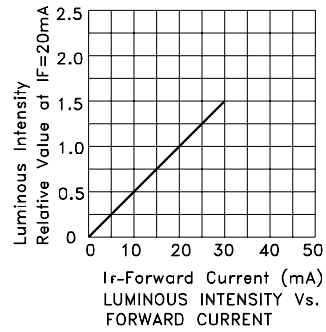
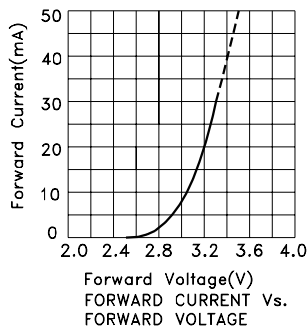

## APHHS1005PBC/A

Reflow Soldering Profile For Lead-free SMT Process.

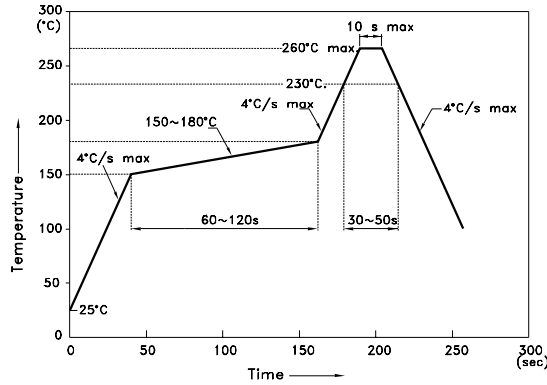

NOTES:

1. We recommend the reflow temperature 245°C(+/-5°C). The maximum soldering temperature should be limited to 260°C.
2. Don't cause stress to the epoxy resin while it is exposed to high temperature.
3. Number of reflow process shall be 2 times or less.

### Recommended Soldering Pattern (Units : mm; Tolerance: ± 0.1)

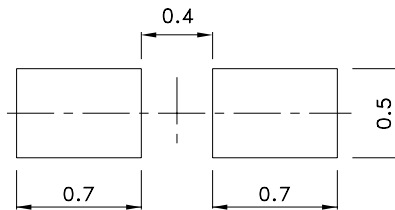

### Tape Specifications (Units : mm)

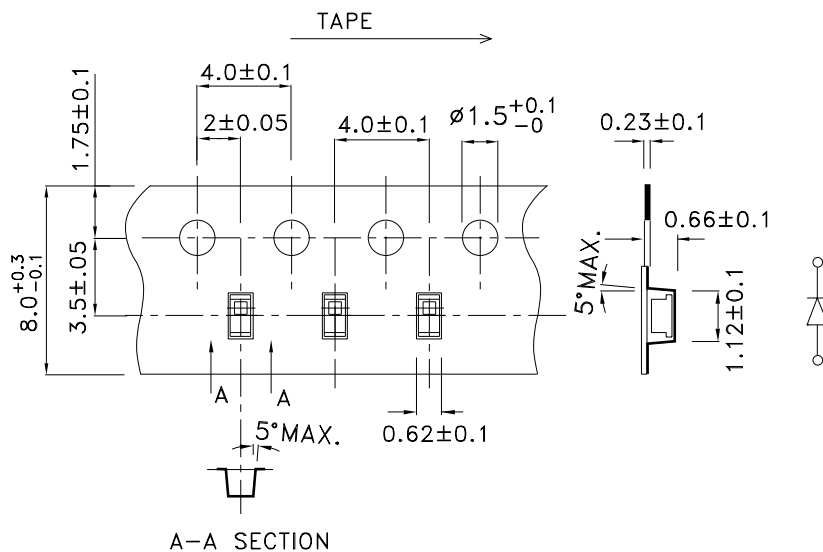

# Kingbright

## PACKING & LABEL SPECIFICATIONS

## APHHS1005PBC/A

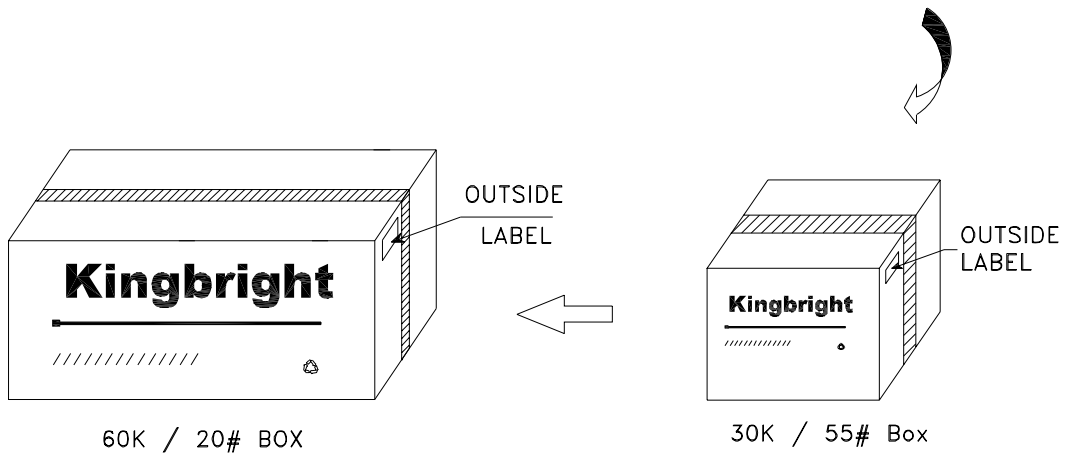
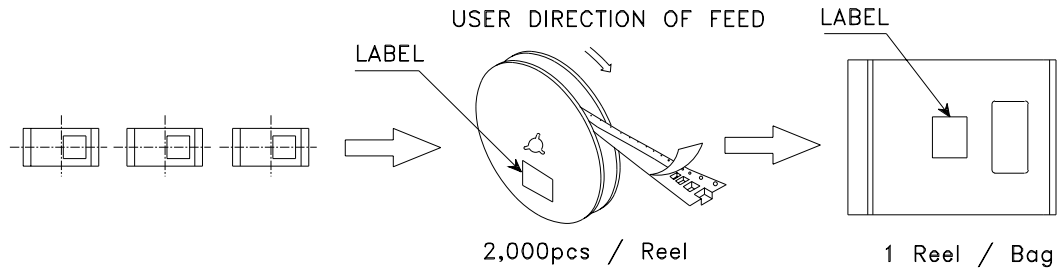

|  |  |
|--|--|
| <h1>Kingbright</h1>  |  |
| P/NO: APHHS1005xxx   |  |
| QTY: 2000 pcs  | Q.C. <span style="border: 1px solid black; border-radius: 50%; padding: 2px;">Q C<br/>xx xx xxxx<br/>PASSED</span> |
| S/N: XXXX  |  |
| CODE: XXX  |  |
| LOT NO:  |  |
|  |  |
| MADE IN CHINA  | RoHS Compliant   |