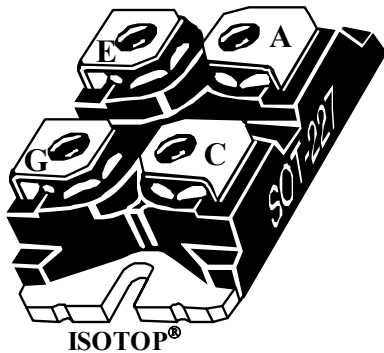
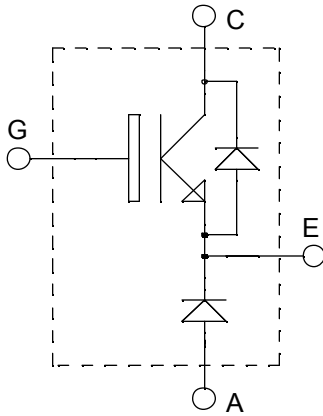

**ISOTOP<sup>®</sup> Buck chopper  
NPT IGBT**
 $V_{CES} = 600V$   
 $I_C = 60A @ T_c = 95^{\circ}C$ 

**Application**

- AC and DC motor control
- Switched Mode Power Supplies

**Features**

- Non Punch Through (NPT) THUNDERBOLT IGBT<sup>®</sup>
  - Low voltage drop
  - Low tail current
  - Switching frequency up to 100 kHz
  - Soft recovery parallel diodes
  - Low diode VF
  - Low leakage current
  - Avalanche energy rated
  - RBSOA and SCSOA rated
- ISOTOP<sup>®</sup> Package (SOT-227)
- Very low stray inductance
- High level of integration

**Benefits**

- Outstanding performance at high frequency operation
- Stable temperature behavior
- Very rugged
- Direct mounting to heatsink (isolated package)
- Low junction to case thermal resistance
- Easy paralleling due to positive  $T_C$  of  $V_{CESat}$
- RoHS Compliant

**Absolute maximum ratings**

Symbol	Parameter	Max ratings	Unit
$V_{CES}$	Collector - Emitter Breakdown Voltage	600	V
$I_{C1}$	Continuous Collector Current	$T_C = 25^{\circ}C$	A
$I_{C2}$		$T_C = 95^{\circ}C$	
$I_{CM}$	Pulsed Collector Current	$T_C = 25^{\circ}C$	360
$V_{GE}$	Gate - Emitter Voltage	$\pm 20$	V
$P_D$	Maximum Power Dissipation	$T_C = 25^{\circ}C$	378
$I_{LM}$	RBSOA clamped Inductive load Current $R_G = 11\Omega$	$T_C = 25^{\circ}C$	360
$I_{FAV}$	Maximum Average Forward Current	Duty cycle=0.5 $T_C = 80^{\circ}C$	30
$I_{FRMS}$	RMS Forward Current (Square wave, 50% duty)		39

 **CAUTION:** These Devices are sensitive to Electrostatic Discharge. Proper Handling Procedures Should Be Followed.

All ratings @  $T_j = 25^\circ\text{C}$  unless otherwise specified

**Electrical Characteristics**

<i>Symbol</i>	<i>Characteristic</i>	<i>Test Conditions</i>	<i>Min</i>	<i>Typ</i>	<i>Max</i>	<i>Unit</i>
$BV_{CES}$	Collector - Emitter Breakdown Voltage	$V_{GE} = 0V, I_C = 0.5mA$	600			V
$I_{CES}$	Zero Gate Voltage Collector Current	$V_{GE} = 0V$			80	$\mu A$
		$V_{CE} = 600V$			2000	
$V_{CE(on)}$	Collector Emitter on Voltage	$V_{GE} = 15V$		2.0	2.5	V
		$I_C = 60A$			2.8	
$V_{GE(th)}$	Gate Threshold Voltage	$V_{GE} = V_{CE}, I_C = 500\mu A$	3	4	5	V
$I_{GES}$	Gate - Emitter Leakage Current	$V_{GE} = \pm 20V, V_{CE} = 0V$			$\pm 100$	nA

**Dynamic Characteristics**

<i>Symbol</i>	<i>Characteristic</i>	<i>Test Conditions</i>	<i>Min</i>	<i>Typ</i>	<i>Max</i>	<i>Unit</i>
$C_{ies}$	Input Capacitance	$V_{GE} = 0V$		3125	3590	pF
$C_{oes}$	Output Capacitance	$V_{CE} = 25V$		310	450	
$C_{res}$	Reverse Transfer Capacitance	$f = 1MHz$		180	310	
$Q_g$	Total gate Charge	$V_{GS} = 15V$		257	410	nC
$Q_{ge}$	Gate - Emitter Charge	$V_{Bus} = 300V$		19	30	
$Q_{gc}$	Gate - Collector Charge	$I_C = 60A$		120	180	
$T_{d(on)}$	Turn-on Delay Time	Resistive Switching ( $25^\circ\text{C}$ )		20	40	ns
$T_r$	Rise Time	$V_{GE} = 15V$		95	190	
$T_{d(off)}$	Turn-off Delay Time	$V_{Bus} = 300V$		315	470	
$T_f$	Fall Time	$I_C = 60A$		245	490	
$T_{d(on)}$	Turn-on Delay Time	Inductive Switching ( $25^\circ\text{C}$ )		26	50	ns
$T_r$	Rise Time	$V_{GE} = 15V$		63	125	
$T_{d(off)}$	Turn-off Delay Time	$V_{Bus} = 400V$		395	590	
$T_f$	Fall Time	$I_C = 60A$		68	140	
$E_{ts}$	Total switching Losses	$R_G = 5\Omega$		3.4	7	mJ
$T_{d(on)}$	Turn-on Delay Time	Inductive Switching ( $150^\circ\text{C}$ )		25	50	ns
$T_r$	Rise Time	$V_{GE} = 15V$		59	120	
$T_{d(off)}$	Turn-off Delay Time	$V_{Bus} = 400V$		430	650	
$T_f$	Fall Time	$I_C = 60A$		65	130	
$E_{on}$	Turn-on Switching Energy	$R_G = 5\Omega$		1.6	3.2	mJ
$E_{off}$	Turn-off Switching Energy			2.4	4.8	
$E_{ts}$	Total switching Losses			4.0	8.0	

**Chopper code ratings and characteristics**

<i>Symbol</i>	<i>Characteristic</i>	<i>Test Conditions</i>		<i>Min</i>	<i>Typ</i>	<i>Max</i>	<i>Unit</i>
V <sub>F</sub>	Diode Forward Voltage	I <sub>F</sub> = 30A			1.6	1.8	V
		I <sub>F</sub> = 60A			1.9		
		I <sub>F</sub> = 30A	T <sub>j</sub> = 125°C		1.4		
I <sub>RM</sub>	Maximum Reverse Leakage Current	V <sub>R</sub> = 600V	T <sub>j</sub> = 25°C			250	μA
		V <sub>R</sub> = 600V	T <sub>j</sub> = 125°C			500	
C <sub>T</sub>	Junction Capacitance	V <sub>R</sub> = 200V			44		pF
t <sub>rr</sub>	Reverse Recovery Time	I <sub>F</sub> =1A, V <sub>R</sub> =30V di/dt = 100A/μs	T <sub>j</sub> = 25°C		23		ns
	Reverse Recovery Time		T <sub>j</sub> = 25°C		85		
			T <sub>j</sub> = 125°C		160		
I <sub>RRM</sub>	Maximum Reverse Recovery Current	I <sub>F</sub> = 30A V <sub>R</sub> = 400V di/dt = 200A/μs	T <sub>j</sub> = 25°C		4		A
			T <sub>j</sub> = 125°C		8		
Q <sub>rr</sub>	Reverse Recovery Charge		T <sub>j</sub> = 25°C		130		nC
			T <sub>j</sub> = 125°C		700		
t <sub>rr</sub>	Reverse Recovery Time	I <sub>F</sub> = 30A	T <sub>j</sub> = 125°C		70		ns
Q <sub>rr</sub>	Reverse Recovery Charge	V <sub>R</sub> = 400V			1300		nC
I <sub>RRM</sub>	Maximum Reverse Recovery Current	di/dt = 1000A/μs			30		A

**Thermal and package characteristics**

<i>Symbol</i>	<i>Characteristic</i>		<i>Min</i>	<i>Typ</i>	<i>Max</i>	<i>Unit</i>
R <sub>thJC</sub>	Junction to Case	IGBT			0.33	°C/W
		Diode			1.21	
R <sub>thJA</sub>	Junction to Ambient (IGBT & Diode)				20	
V <sub>ISOL</sub>	RMS Isolation Voltage, any terminal to case t = 1 min, I <sub>isol</sub> < 1mA, 50/60Hz		2500			V
T <sub>J</sub> , T <sub>STG</sub>	Storage Temperature Range		-55		150	°C
T <sub>L</sub>	Max Lead Temp for Soldering: 0.063" from case for 10 sec				300	
Torque	Mounting torque (Mounting = 8-32 or 4mm Machine and terminals = 4mm Machine)				1.5	N.m
Wt	Package Weight			29.2		g

**Typical IGBT Performance Curve**

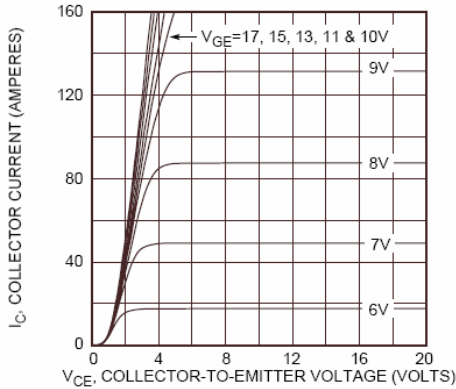

**Figure 1, Typical Output Characteristics ( $T_J = 25^\circ\text{C}$ )**

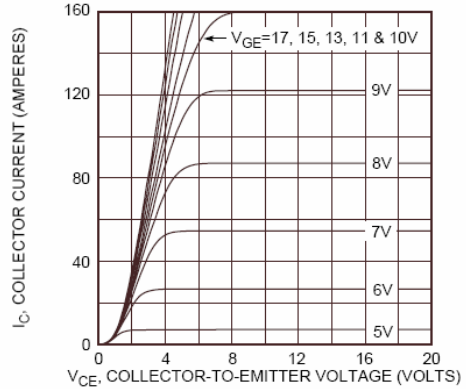

**Figure 2, Typical Output Characteristics ( $T_J = 150^\circ\text{C}$ )**

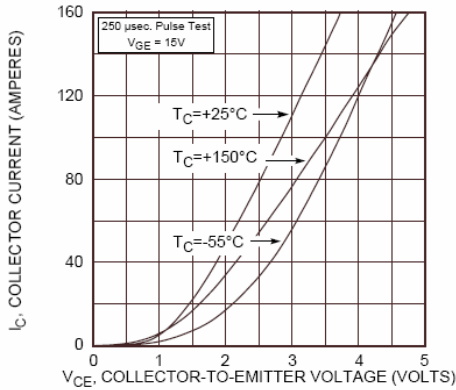

**Figure 3, Typical Output Characteristics @  $V_{GE} = 15\text{V}$**

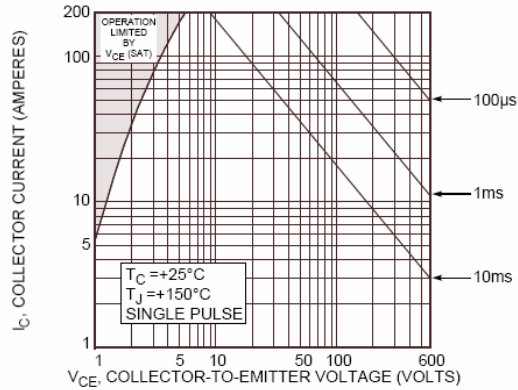

**Figure 4, Maximum Forward Safe Operating Area**

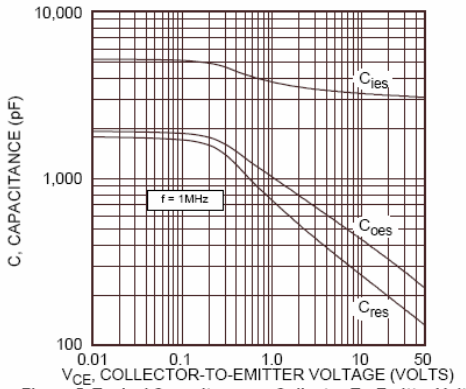

**Figure 5, Typical Capacitance vs Collector-To-Emitter Voltage**

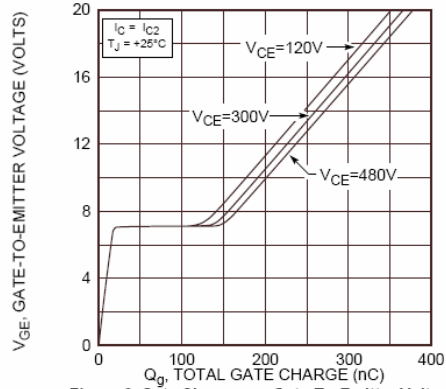

**Figure 6, Gate Charges vs Gate-To-Emitter Voltage**

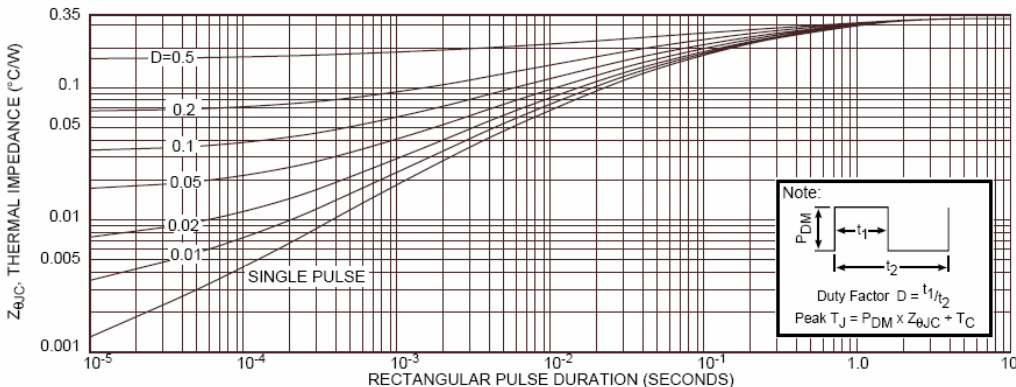

**Figure 7, Maximum Effective Transient Thermal Impedance, Junction-To-Case vs Pulse Duration**

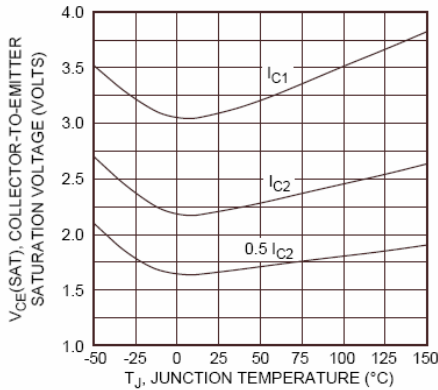

Figure 8, Typical  $V_{CE(SAT)}$  Voltage vs Junction Temperature

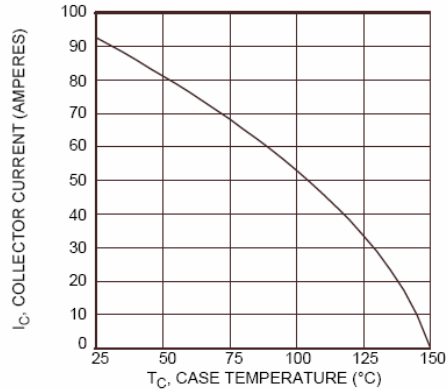

Figure 9, Maximum Collector Current vs Case Temperature

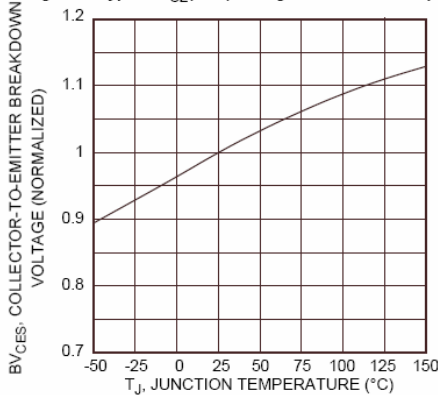

Figure 10, Breakdown Voltage vs Junction Temperature

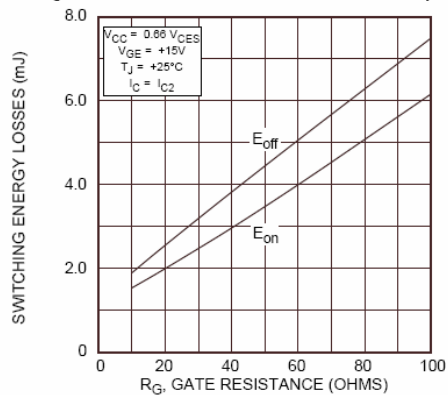

Figure 11, Typical Switching Energy Losses vs Gate Resistance

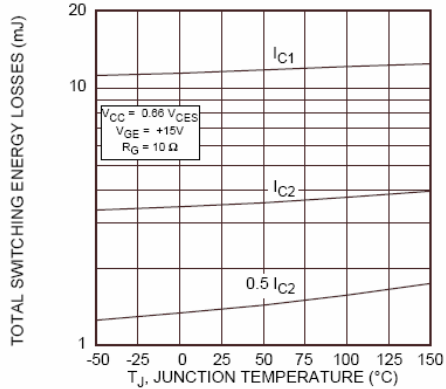

Figure 12, Typical Switching Energy Losses vs. Junction Temperature

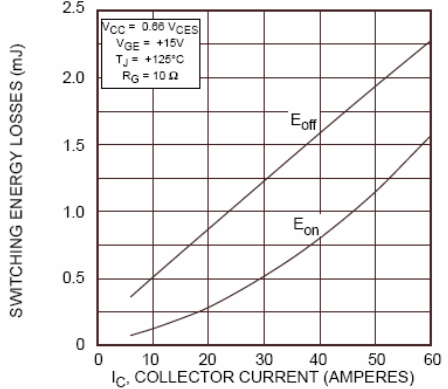

Figure 13, Typical Switching Energy Losses vs Collector Current

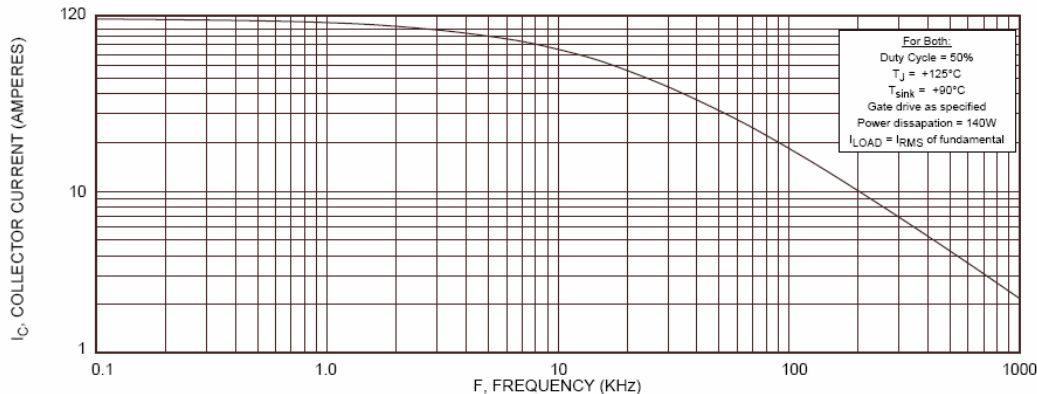

Figure 14, Typical Load Current vs Frequency

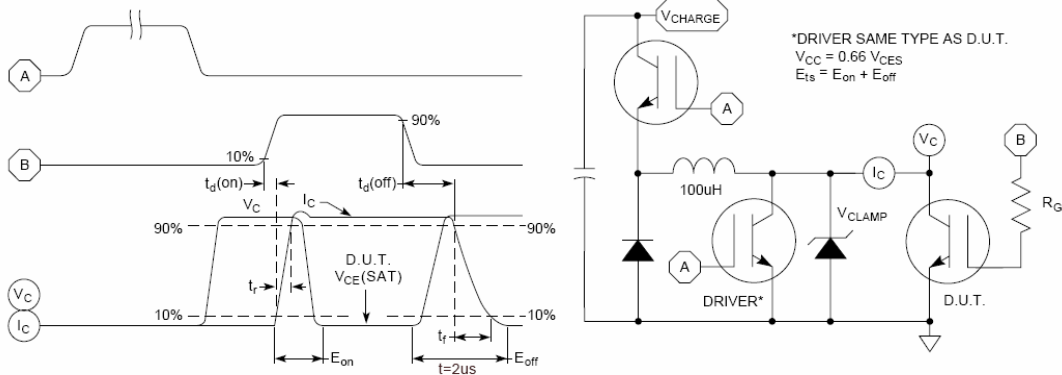

Figure 15, Switching Loss Test Circuit and Waveforms

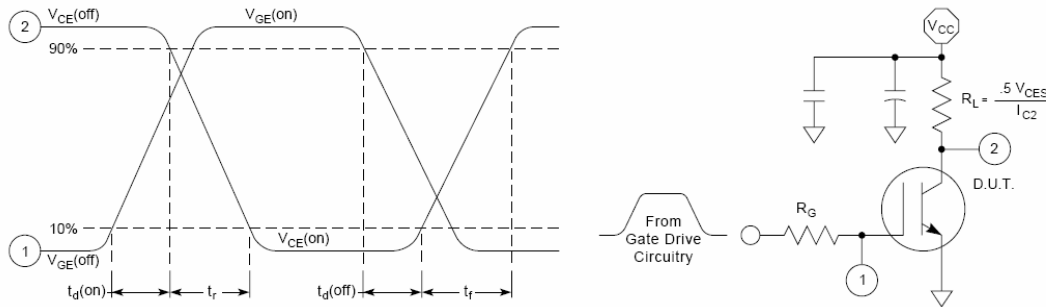

Figure 16, Resistive Switching Time Test Circuit and Waveforms

**Typical Diode Performance Curve**

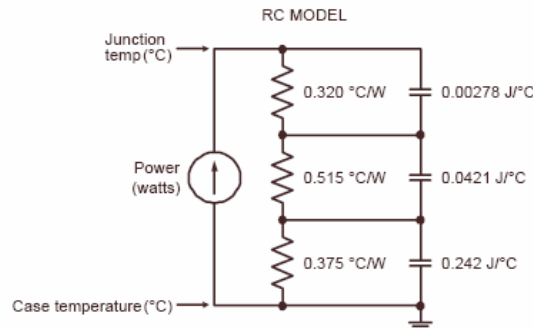
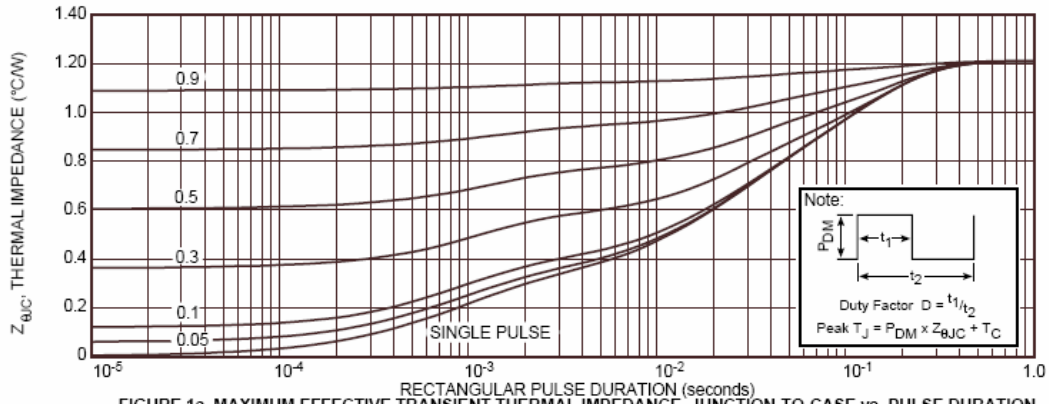

FIGURE 1b, TRANSIENT THERMAL IMPEDANCE MODEL

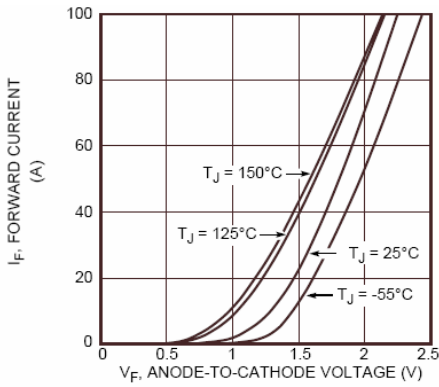

Figure 2. Forward Current vs. Forward Voltage

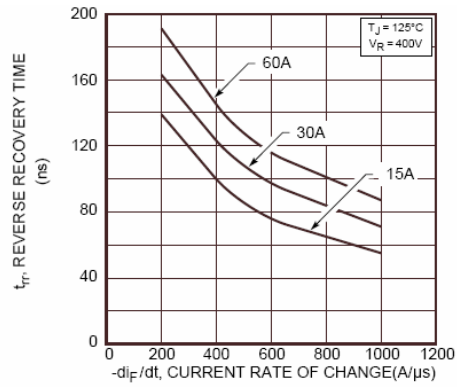

Figure 3. Reverse Recovery Time vs. Current Rate of Change

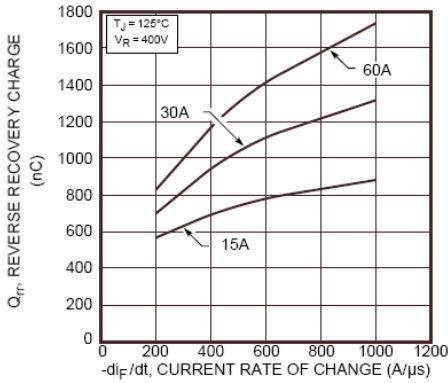

Figure 4. Reverse Recovery Charge vs. Current Rate of Change

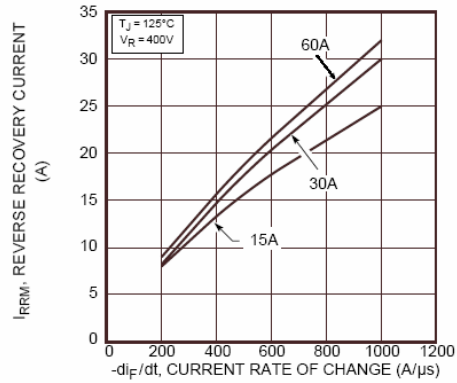

Figure 5. Reverse Recovery Current vs. Current Rate of Change

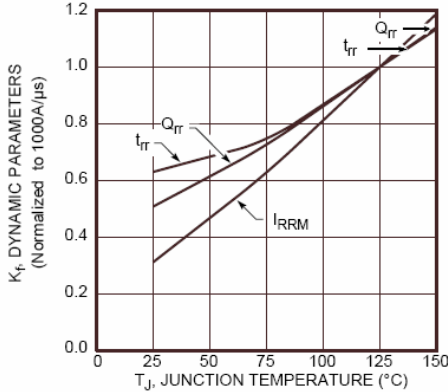

Figure 6. Dynamic Parameters vs. Junction Temperature

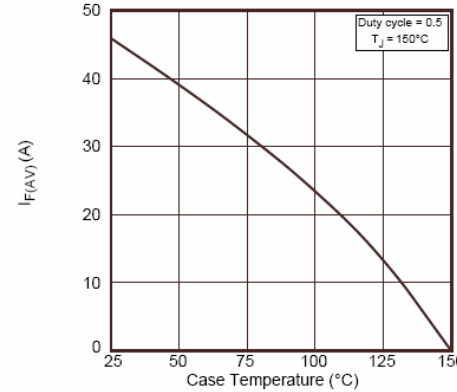

Figure 7. Maximum Average Forward Current vs. Case Temperature

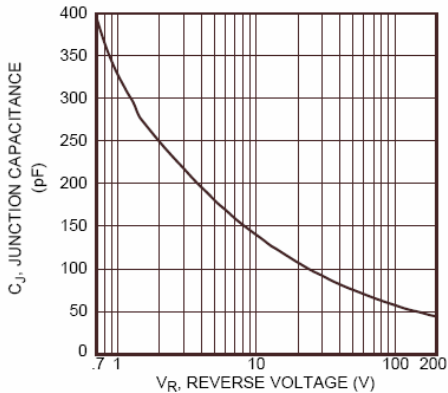

Figure 8. Junction Capacitance vs. Reverse Voltage

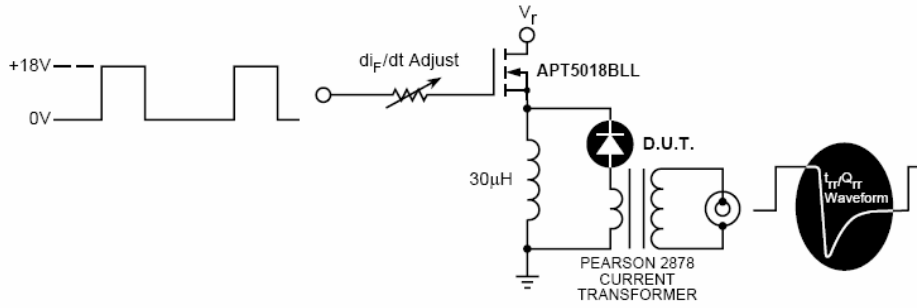

Figure 9. Diode Test Circuit

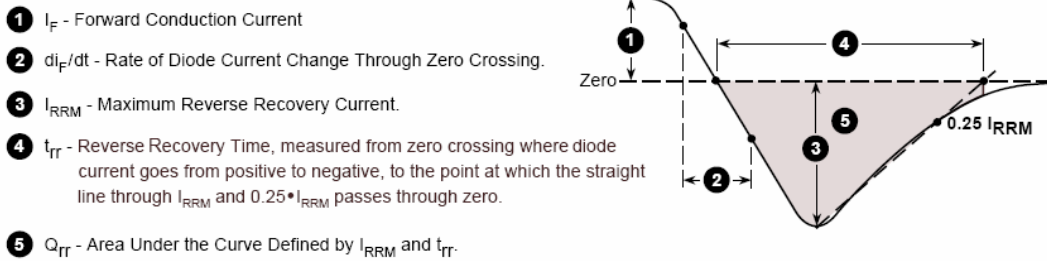
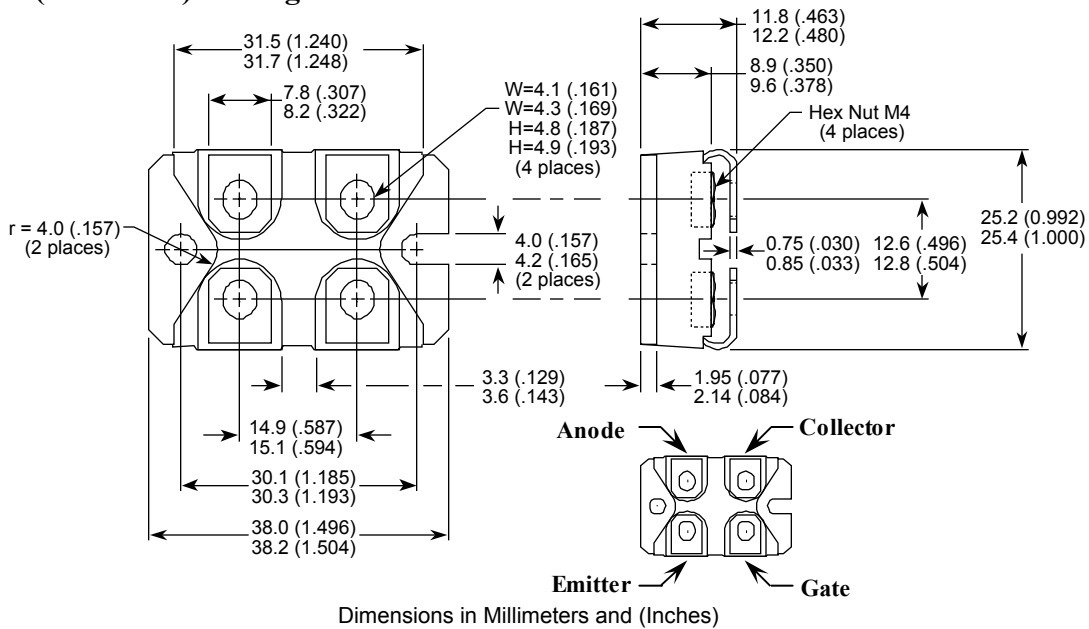

Figure 10. Diode Reverse Recovery Waveform and Definitions

**SOT-227 (ISOTOP<sup>®</sup>) Package Outline**



ISOTOP<sup>®</sup> is a registered trademark of ST Microelectronics NV

Microsemi reserves the right to change, without notice, the specifications and information contained herein

Microsemi's products are covered by one or more of U.S. patents 4,895,810 5,045,903 5,089,434 5,182,234 5,019,522 5,262,336 6,503,786 5,256,583 4,748,103 5,283,202 5,231,474 5,434,095 5,528,058 and foreign patents. U.S. and Foreign patents pending. All Rights Reserved.