

## Full - Bridge Super Junction MOSFET Power Module

$$V_{DSS} = 600V$$

$$R_{DSon} = 35m\Omega \text{ max @ } T_j = 25^\circ C$$

$$I_D = 72A \text{ @ } T_c = 25^\circ C$$

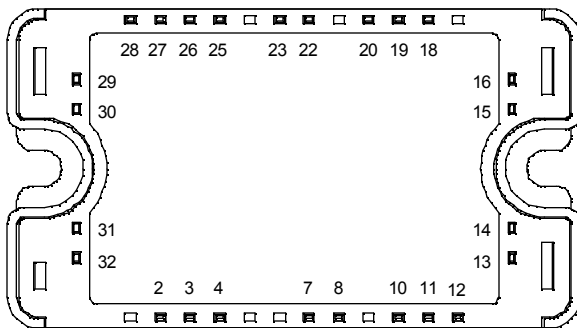
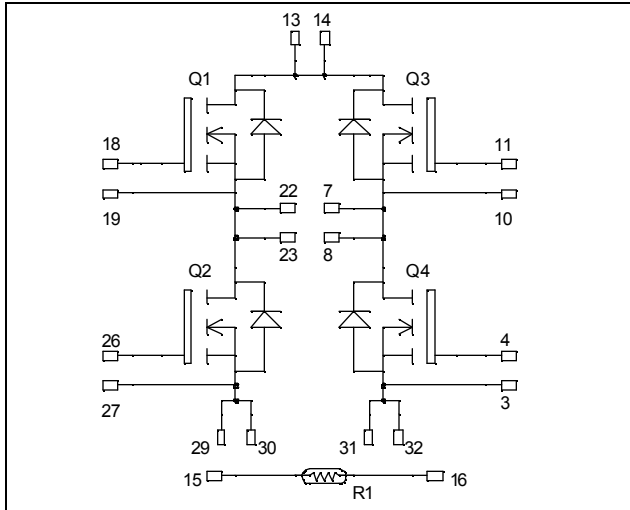

All multiple inputs and outputs must be shorted together  
 Example: 13/14 ; 29/30 ; 22/23 ...

### Application

- Welding converters
- Switched Mode Power Supplies
- Uninterruptible Power Supplies

### Features

- **COOLMOS** Power Semiconductors
  - Ultra low  $R_{DSon}$
  - Low Miller capacitance
  - Ultra low gate charge
  - Avalanche energy rated
  - Very rugged
- Kelvin source for easy drive
- Very low stray inductance
  - Symmetrical design
- Internal thermistor for temperature monitoring
- High level of integration

### Benefits

- Outstanding performance at high frequency operation
- Direct mounting to heatsink (isolated package)
- Low junction to case thermal resistance
- Solderable terminals both for power and signal for easy PCB mounting
- Low profile
- Each leg can be easily paralleled to achieve a phase leg of twice the current capability
- RoHS Compliant

### Absolute maximum ratings

Symbol	Parameter	Max ratings	Unit
$V_{DSS}$	Drain - Source Breakdown Voltage	600	V
$I_D$	Continuous Drain Current	$T_c = 25^\circ C$	72
		$T_c = 80^\circ C$	54
$I_{DM}$	Pulsed Drain current	200	
$V_{GS}$	Gate - Source Voltage	$\pm 20$	V
$R_{DSon}$	Drain - Source ON Resistance	35	$m\Omega$
$P_D$	Maximum Power Dissipation	$T_c = 25^\circ C$	416
$I_{AR}$	Avalanche current (repetitive and non repetitive)	20	A
$E_{AR}$	Repetitive Avalanche Energy	1	mJ
$E_{AS}$	Single Pulse Avalanche Energy	1800	

**CAUTION:** These Devices are sensitive to Electrostatic Discharge. Proper Handling Procedures Should Be Followed. See application note APT0502 on [www.microsemi.com](http://www.microsemi.com)

All ratings @  $T_j = 25^\circ\text{C}$  unless otherwise specified

**Electrical Characteristics**

Symbol	Characteristic	Test Conditions	Min	Typ	Max	Unit
$I_{DSS}$	Zero Gate Voltage Drain Current	$V_{GS} = 0V, V_{DS} = 600V$			40	$\mu\text{A}$
		$T_j = 25^\circ\text{C}$				
$R_{DS(on)}$	Drain – Source on Resistance	$V_{GS} = 0V, V_{DS} = 600V$			375	$\text{m}\Omega$
		$T_j = 125^\circ\text{C}$				
$V_{GS(th)}$	Gate Threshold Voltage	$V_{GS} = V_{DS}, I_D = 5.4\text{mA}$	2.1	3	3.9	V
$I_{GSS}$	Gate – Source Leakage Current	$V_{GS} = \pm 20V, V_{DS} = 0V$			$\pm 150$	nA

**Dynamic Characteristics**

Symbol	Characteristic	Test Conditions	Min	Typ	Max	Unit
$C_{iss}$	Input Capacitance	$V_{GS} = 0V$		14		nF
$C_{oss}$	Output Capacitance	$V_{DS} = 25V$		5.13		
$C_{rss}$	Reverse Transfer Capacitance	$f = 1\text{MHz}$		0.42		
$Q_g$	Total gate Charge	$V_{GS} = 10V$		518		nC
$Q_{gs}$	Gate – Source Charge	$V_{Bus} = 300V$		58		
$Q_{gd}$	Gate – Drain Charge	$I_D = 72A$		222		
$T_{d(on)}$	Turn-on Delay Time	<b>Inductive Switching @ 125°C</b> $V_{GS} = 15V$ $V_{Bus} = 400V$ $I_D = 72A$ $R_G = 2.5\Omega$		21		ns
$T_r$	Rise Time			30		
$T_{d(off)}$	Turn-off Delay Time			283		
$T_f$	Fall Time			84		
$E_{on}$	Turn-on Switching Energy	<b>Inductive switching @ 25°C</b> $V_{GS} = 15V, V_{Bus} = 400V$ $I_D = 72A, R_G = 2.5\Omega$		1340		$\mu\text{J}$
$E_{off}$	Turn-off Switching Energy			1960		
$E_{on}$	Turn-on Switching Energy	<b>Inductive switching @ 125°C</b> $V_{GS} = 15V, V_{Bus} = 400V$ $I_D = 72A, R_G = 2.5\Omega$		2192		$\mu\text{J}$
$E_{off}$	Turn-off Switching Energy			2412		

**Source - Drain diode ratings and characteristics**

Symbol	Characteristic	Test Conditions	Min	Typ	Max	Unit
$I_S$	Continuous Source current (Body diode)	$T_c = 25^\circ\text{C}$		72		A
		$T_c = 80^\circ\text{C}$		54		
$V_{SD}$	Diode Forward Voltage	$V_{GS} = 0V, I_S = -72A$			1.2	V
$dv/dt$	Peak Diode Recovery ①				6	V/ns
$t_{rr}$	Reverse Recovery Time	$I_S = -72A$ $V_R = 350V$		580		ns
$Q_{rr}$	Reverse Recovery Charge	$di/dt = 200A/\mu\text{s}$		46		$\mu\text{C}$

 ①  $dv/dt$  numbers reflect the limitations of the circuit rather than the device itself.

$$I_S \leq -72A \quad di/dt \leq 200A/\mu\text{s} \quad V_R \leq V_{DSS} \quad T_j \leq 150^\circ\text{C}$$

**Thermal and package characteristics**

Symbol	Characteristic	Min	Typ	Max	Unit	
R <sub>thJC</sub>	Junction to Case Thermal Resistance			0.30	°C/W	
V <sub>ISOL</sub>	RMS Isolation Voltage, any terminal to case t=1 min, I <sub>isol</sub> <1mA, 50/60Hz	2500			V	
T <sub>J</sub>	Operating junction temperature range	-40		150	°C	
T <sub>STG</sub>	Storage Temperature Range	-40		125		
T <sub>C</sub>	Operating Case Temperature	-40		100		
Torque	Mounting torque	To heatsink	M4	2.5	4.7	N.m
Wt	Package Weight				110	g

**Temperature sensor NTC** (see application note APT0406 on www.microsemi.com for more information).

Symbol	Characteristic	Min	Typ	Max	Unit
R <sub>25</sub>	Resistance @ 25°C		50		kΩ
B <sub>25/85</sub>	T <sub>25</sub> = 298.15 K		3952		K

$$R_T = \frac{R_{25}}{\exp\left[B_{25/85}\left(\frac{1}{T_{25}} - \frac{1}{T}\right)\right]}$$

T: Thermistor temperature  
 R<sub>T</sub>: Thermistor value at T

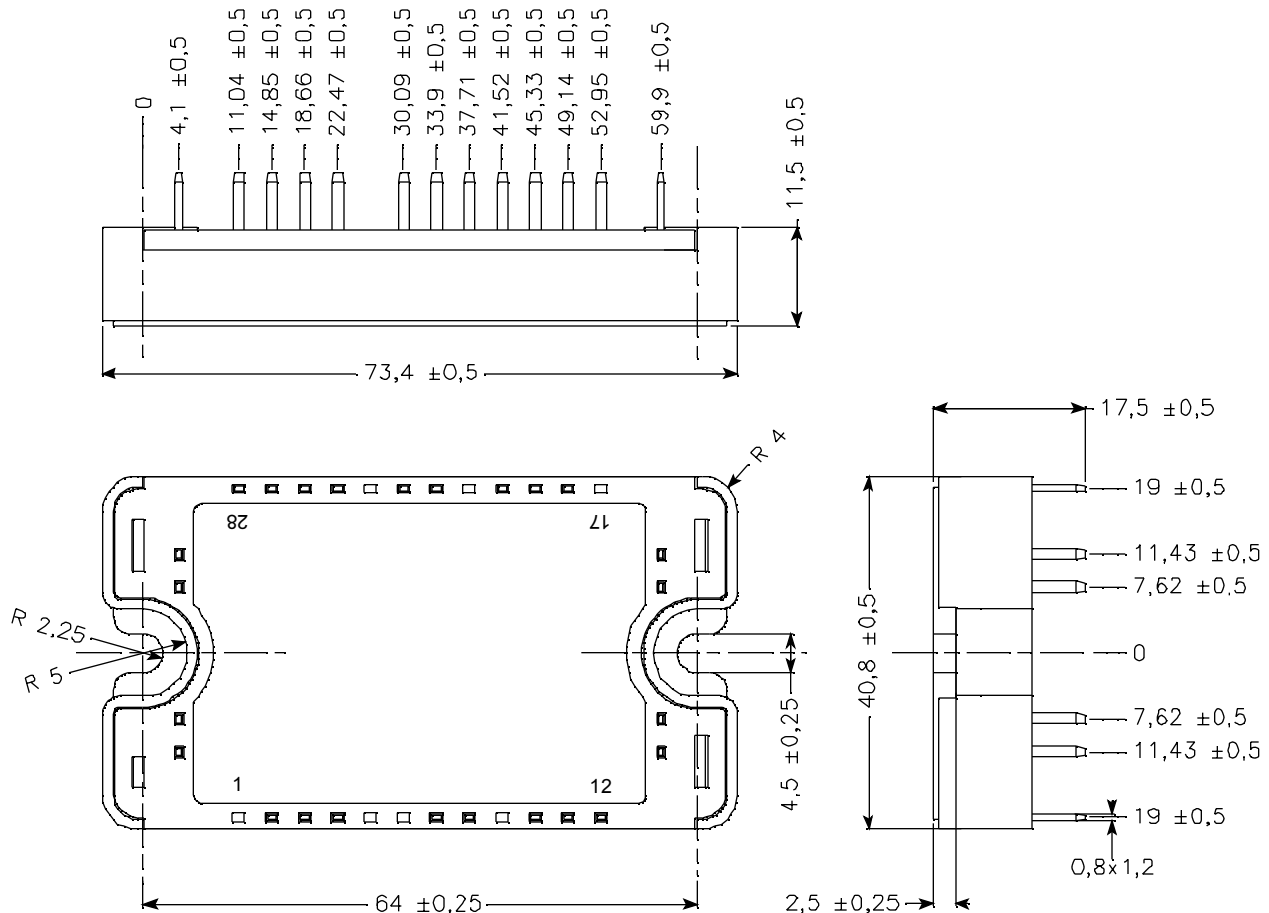
**SP3 Package outline** (dimensions in mm)

See application note 1901 - Mounting Instructions for SP3 Power Modules on www.microsemi.com

## Typical Performance Curve

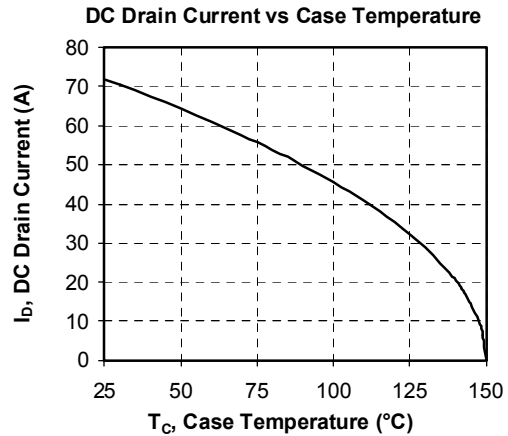
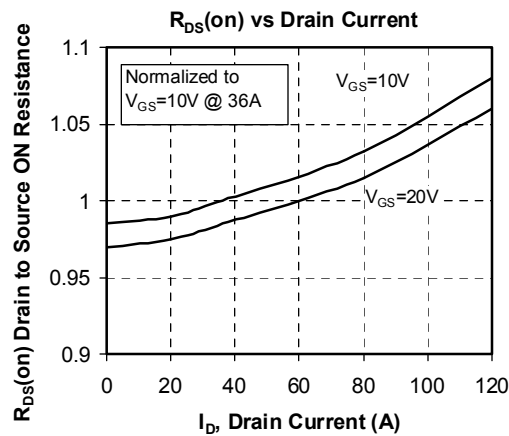
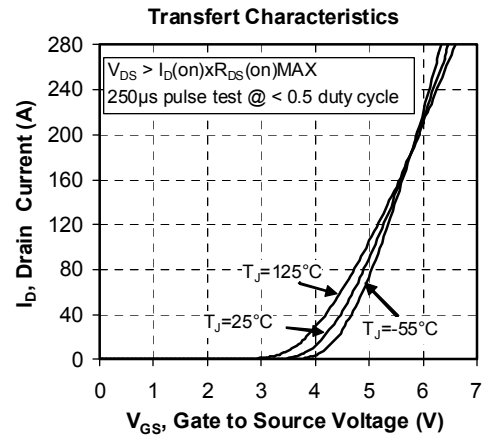
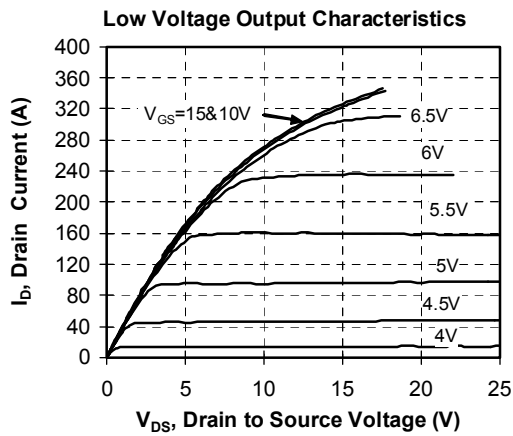
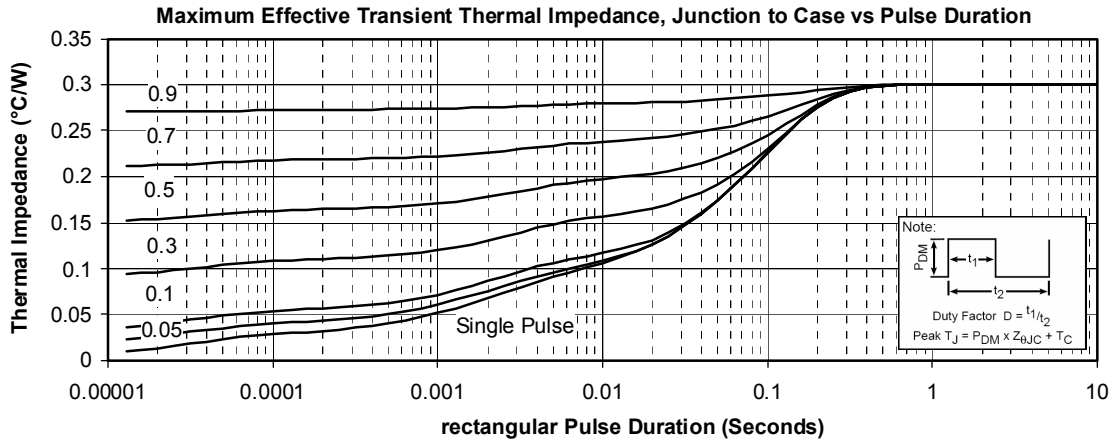

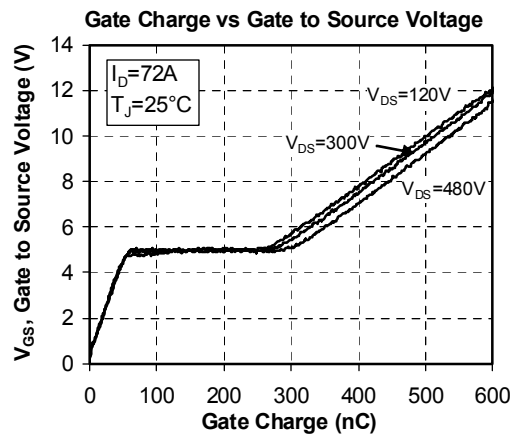
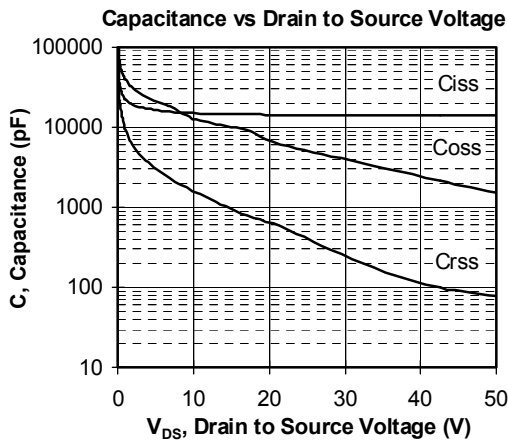
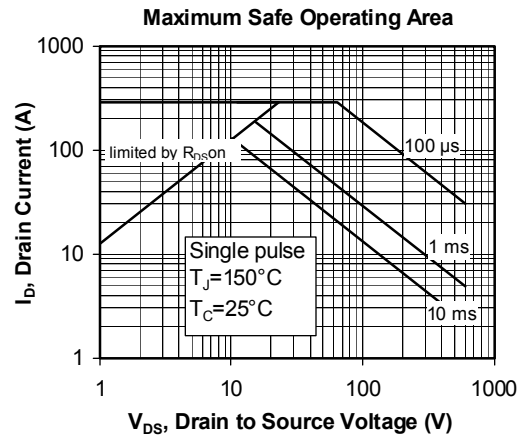
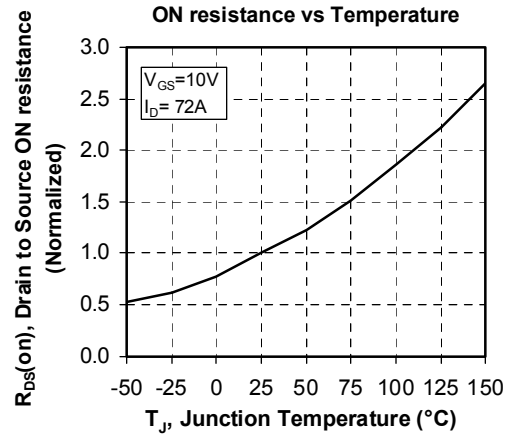

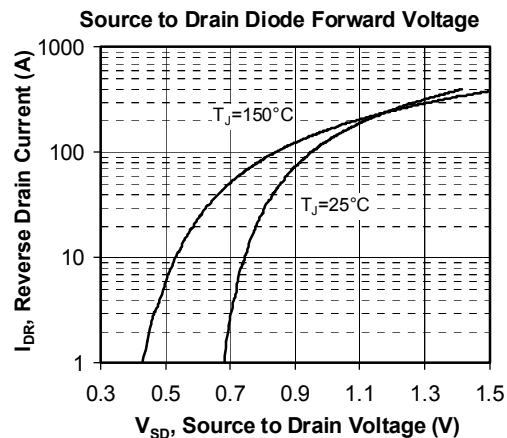
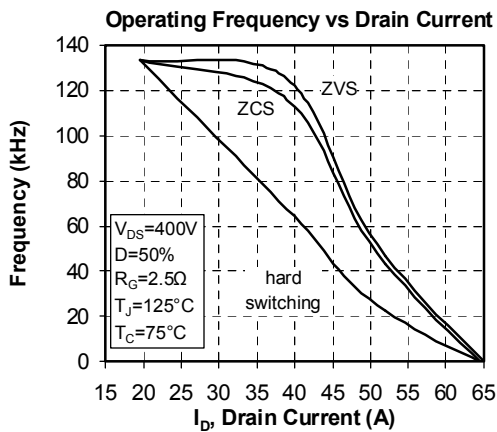
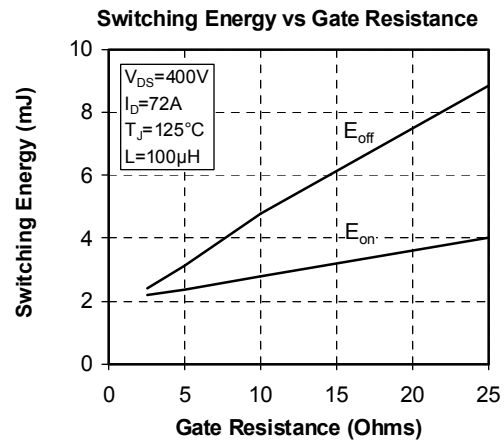
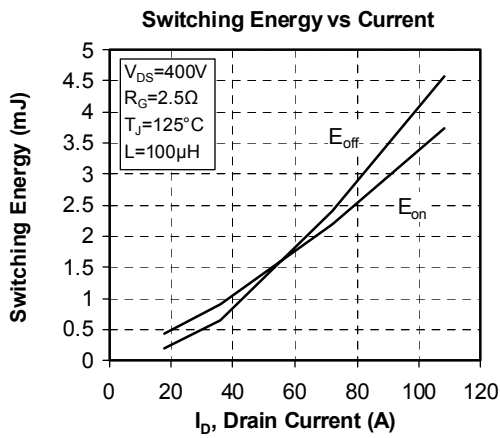
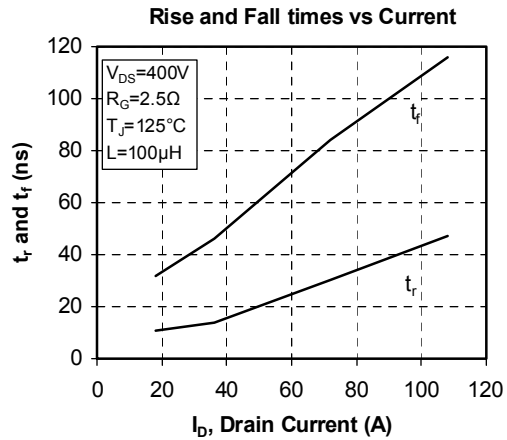
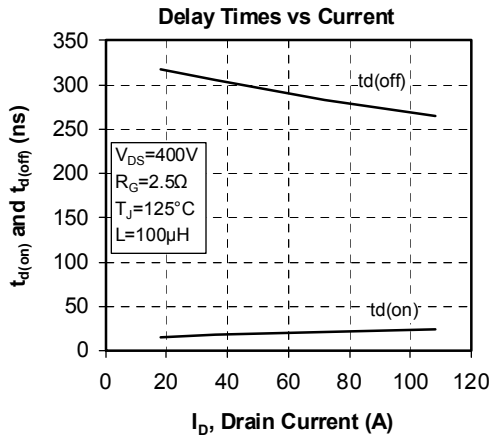

“COOLMOST™ comprise a new family of transistors developed by Infineon Technologies AG. “COOLMOS” is a trademark of Infineon Technologies AG”.

Microsemi reserves the right to change, without notice, the specifications and information contained herein

Microsemi's products are covered by one or more of U.S. patents 4,895,810 5,045,903 5,089,434 5,182,234 5,019,522 5,262,336 6,503,786 5,256,583 4,748,103 5,283,202 5,231,474 5,434,095 5,528,058 and foreign patents. U.S. and Foreign patents pending. All Rights Reserved.