

**Full - Bridge  
MOSFET Power Module**

**$V_{DSS} = 100V$   
 $R_{DSon} = 19m\Omega$  typ @  $T_j = 25^\circ C$   
 $I_D = 70A$  @  $T_c = 25^\circ C$**

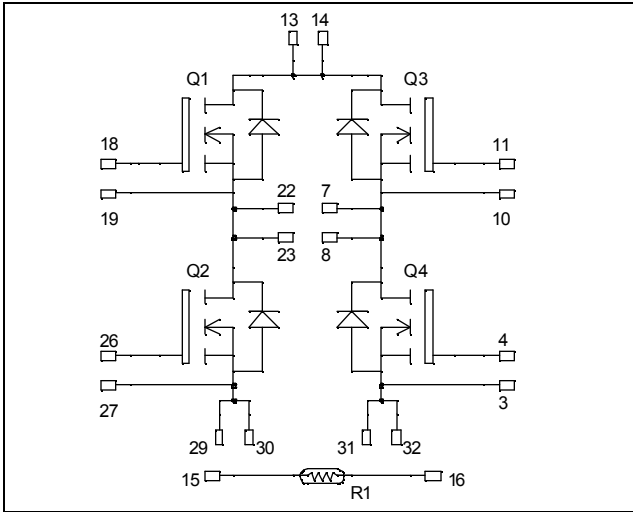

**Application**

- Welding converters
- Switched Mode Power Supplies
- Uninterruptible Power Supplies
- Motor control

**Features**

- Power MOS V<sup>®</sup> FREDFETs
  - Low  $R_{DSon}$
  - Low input and Miller capacitance
  - Low gate charge
  - Fast intrinsic diode
  - Avalanche energy rated
  - Very rugged
- Kelvin source for easy drive
- Very low stray inductance
  - Symmetrical design
- Internal thermistor for temperature monitoring
- High level of integration

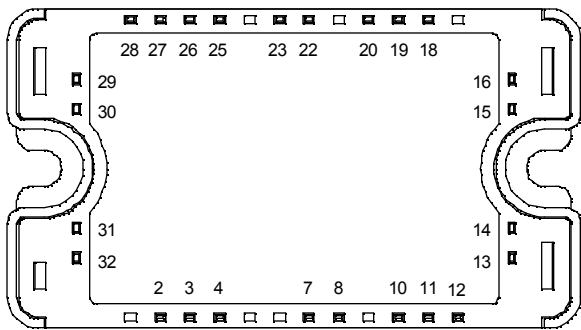

**Benefits**

- Outstanding performance at high frequency operation
- Direct mounting to heatsink (isolated package)
- Low junction to case thermal resistance
- Solderable terminals both for power and signal for easy PCB mounting
- Low profile
- Each leg can be easily paralleled to achieve a phase leg of twice the current capability

All multiple inputs and outputs must be shorted together  
Example: 13/14 ; 29/30 ; 22/23 ...

**Absolute maximum ratings**

Symbol	Parameter	Max ratings	Unit
$V_{DSS}$	Drain - Source Breakdown Voltage	100	V
$I_D$	Continuous Drain Current	$T_c = 25^\circ C$	70
		$T_c = 80^\circ C$	50
$I_{DM}$	Pulsed Drain current	300	A
$V_{GS}$	Gate - Source Voltage	$\pm 30$	V
$R_{DSon}$	Drain - Source ON Resistance	20	$m\Omega$
$P_D$	Maximum Power Dissipation	$T_c = 25^\circ C$	208
$I_{AR}$	Avalanche current (repetitive and non repetitive)	75	A
$E_{AR}$	Repetitive Avalanche Energy	30	mJ
$E_{AS}$	Single Pulse Avalanche Energy	1500	

**CAUTION:** These Devices are sensitive to Electrostatic Discharge. Proper Handling Procedures Should Be Followed.

All ratings @  $T_j = 25^\circ\text{C}$  unless otherwise specified

## Electrical Characteristics

Symbol	Characteristic	Test Conditions	Min	Typ	Max	Unit
$I_{DSS}$	Zero Gate Voltage Drain Current	$V_{GS} = 0\text{V}, V_{DS} = 100\text{V}$			250	$\mu\text{A}$
		$V_{GS} = 0\text{V}, V_{DS} = 80\text{V}$			1000	
$R_{DS(on)}$	Drain – Source on Resistance	$V_{GS} = 10\text{V}, I_D = 35\text{A}$		19	20	$\text{m}\Omega$
$V_{GS(th)}$	Gate Threshold Voltage	$V_{GS} = V_{DS}, I_D = 1\text{mA}$	2		4	V
$I_{GSS}$	Gate – Source Leakage Current	$V_{GS} = \pm 30\text{V}, V_{DS} = 0\text{V}$			$\pm 100$	nA

## Dynamic Characteristics

Symbol	Characteristic	Test Conditions	Min	Typ	Max	Unit
$C_{iss}$	Input Capacitance	$V_{GS} = 0\text{V}$ $V_{DS} = 25\text{V}$ $f = 1\text{MHz}$		5100		pF
$C_{oss}$	Output Capacitance			1900		
$C_{rss}$	Reverse Transfer Capacitance			800		
$Q_g$	Total gate Charge	$V_{GS} = 10\text{V}$ $V_{Bus} = 100\text{V}$ $I_D = 70\text{A}$		200		nC
$Q_{gs}$	Gate – Source Charge			40		
$Q_{gd}$	Gate – Drain Charge			92		
$T_{d(on)}$	Turn-on Delay Time	<b>Inductive switching @ <math>125^\circ\text{C}</math></b> $V_{GS} = 15\text{V}$ $V_{Bus} = 66\text{V}$ $I_D = 70\text{A}$ $R_G = 5\Omega$		35		ns
$T_r$	Rise Time			70		
$T_{d(off)}$	Turn-off Delay Time			95		
$T_f$	Fall Time			125		
$E_{on}$	Turn-on Switching Energy ❶	<b>Inductive switching @ <math>25^\circ\text{C}</math></b> $V_{GS} = 15\text{V}, V_{Bus} = 66\text{V}$ $I_D = 70\text{A}, R_G = 5\Omega$		276		$\mu\text{J}$
$E_{off}$	Turn-off Switching Energy ❷			302		
$E_{on}$	Turn-on Switching Energy ❶	<b>Inductive switching @ <math>125^\circ\text{C}</math></b> $V_{GS} = 15\text{V}, V_{Bus} = 66\text{V}$ $I_D = 70\text{A}, R_G = 5\Omega$		304		$\mu\text{J}$
$E_{off}$	Turn-off Switching Energy ❷			320		

## Source - Drain diode ratings and characteristics

Symbol	Characteristic	Test Conditions	Min	Typ	Max	Unit
$I_S$	Continuous Source current (Body diode)		$T_c = 25^\circ\text{C}$		70	A
			$T_c = 80^\circ\text{C}$		50	
$V_{SD}$	Diode Forward Voltage	$V_{GS} = 0\text{V}, I_S = -70\text{A}$			1.3	V
$dv/dt$	Peak Diode Recovery ❸				5	V/ns
$t_{rr}$	Reverse Recovery Time	$I_S = -70\text{A}$ $di_s/dt = 100\text{A}/\mu\text{s}$	$T_j = 25^\circ\text{C}$		200	ns
			$T_j = 125^\circ\text{C}$		350	
$Q_{rr}$	Reverse Recovery Charge	$I_S = -70\text{A}$ $di_s/dt = 100\text{A}/\mu\text{s}$	$T_j = 25^\circ\text{C}$	0.5		$\mu\text{C}$
			$T_j = 125^\circ\text{C}$	1		

❶  $E_{on}$  includes diode reverse recovery.

❷ In accordance with JEDEC standard JESD24-1.

❸  $dv/dt$  numbers reflect the limitations of the circuit rather than the device itself.

$$I_S \leq -70\text{A} \quad di/dt \leq 700\text{A}/\mu\text{s} \quad V_R \leq V_{DSS} \quad T_j \leq 150^\circ\text{C}$$

**Thermal and package characteristics**

Symbol	Characteristic	Min	Typ	Max	Unit	
R <sub>thJC</sub>	Junction to Case			0.6	°C/W	
V <sub>ISOL</sub>	RMS Isolation Voltage, any terminal to case t =1 min, I <sub>isol</sub> < 1mA, 50/60Hz	2500			V	
T <sub>J</sub>	Operating junction temperature range	-40		150	°C	
T <sub>STG</sub>	Storage Temperature Range	-40		125		
T <sub>C</sub>	Operating Case Temperature	-40		100		
Torque	Mounting torque	To heatsink	M4	1.5	4.7	N.m
Wt	Package Weight				110	g

**Temperature sensor NTC** (for more information see application note APT0406 on [www.advancedpower.com](http://www.advancedpower.com)).

Symbol	Characteristic	Min	Typ	Max	Unit
R <sub>25</sub>	Resistance @ 25°C		50		kΩ
B <sub>25/85</sub>	T <sub>25</sub> = 298.15 K		3952		K

$$R_T = \frac{R_{25}}{\exp \left[ B_{25/85} \left( \frac{1}{T} - \frac{1}{T_{25}} \right) \right]}$$

T: Thermistor temperature  
R<sub>T</sub>: Thermistor value at T

**Package outline** (dimensions in mm)

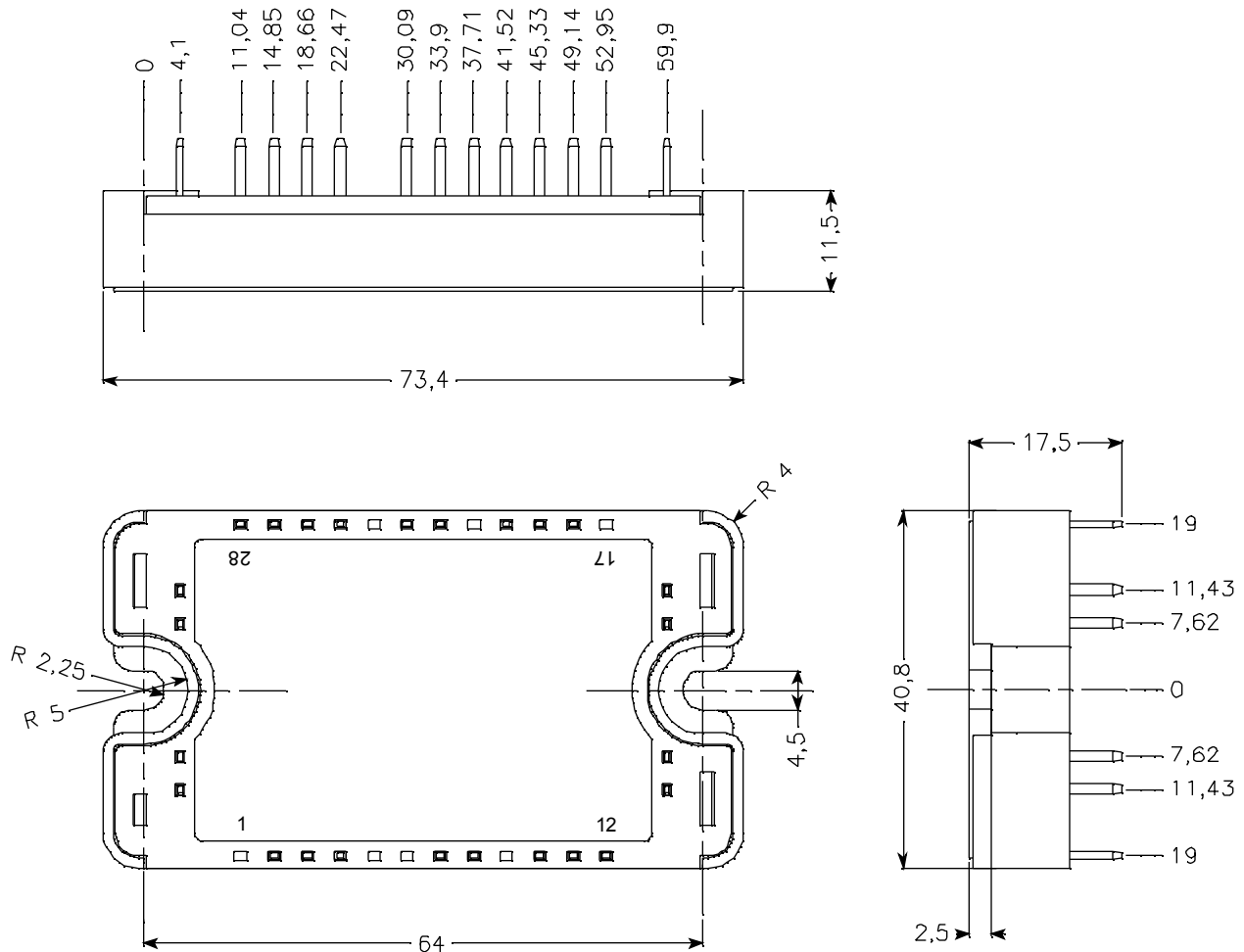

**Typical Performance Curve**

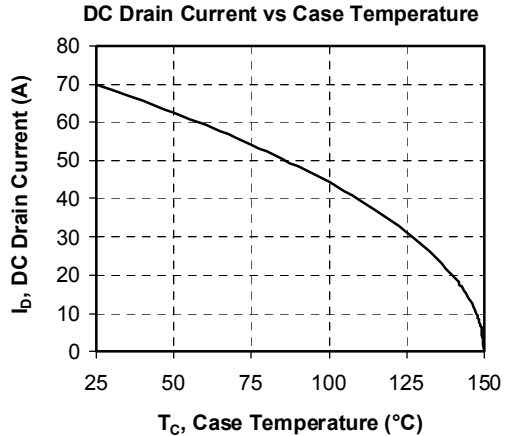
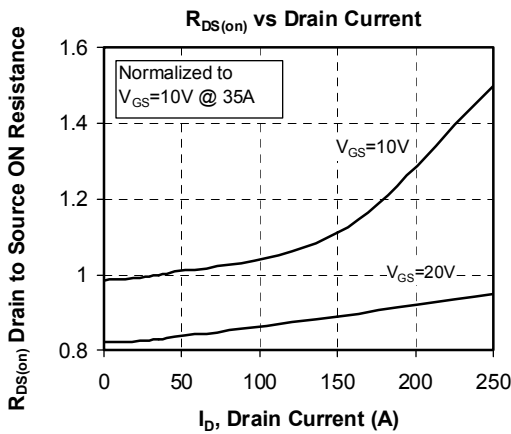
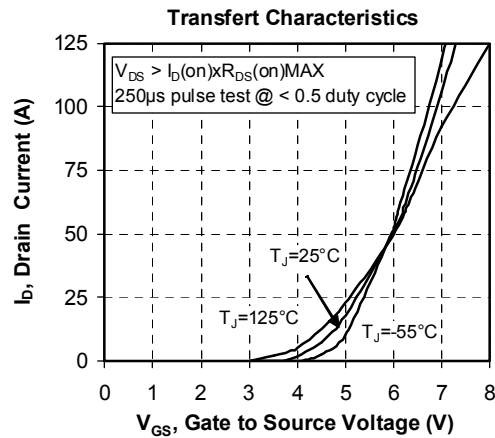
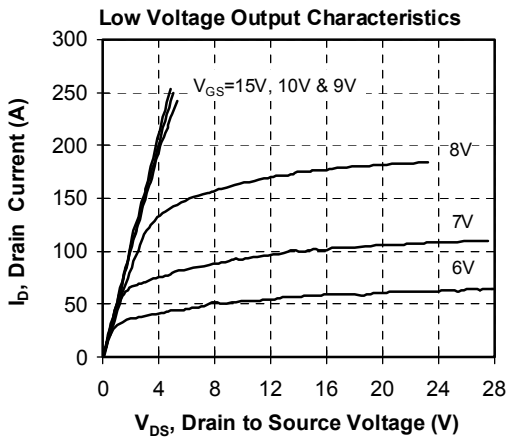
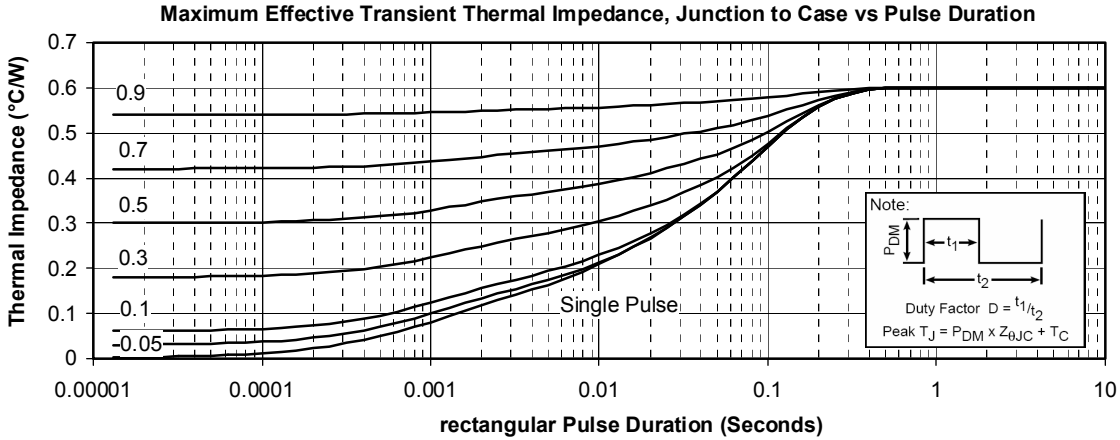

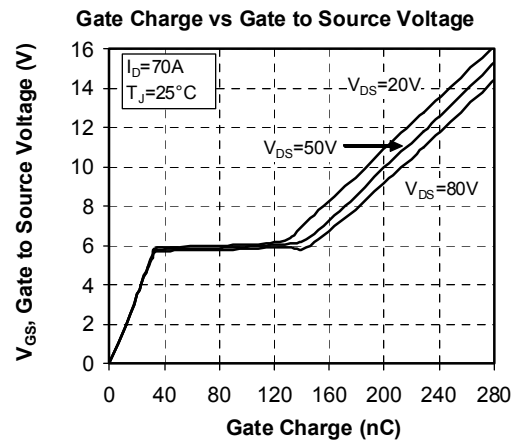
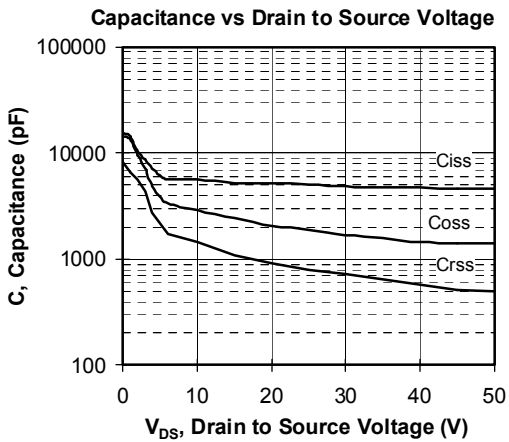
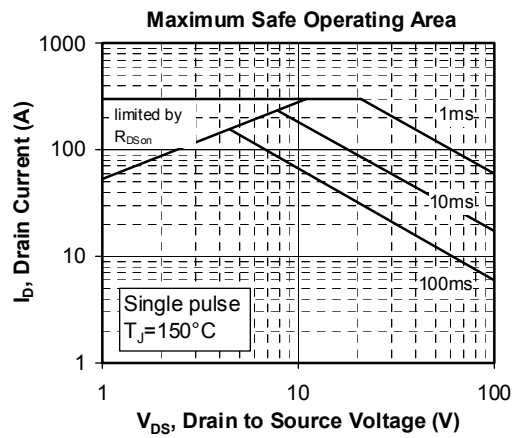
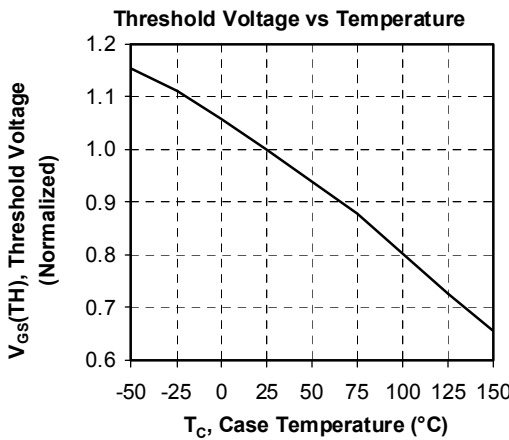
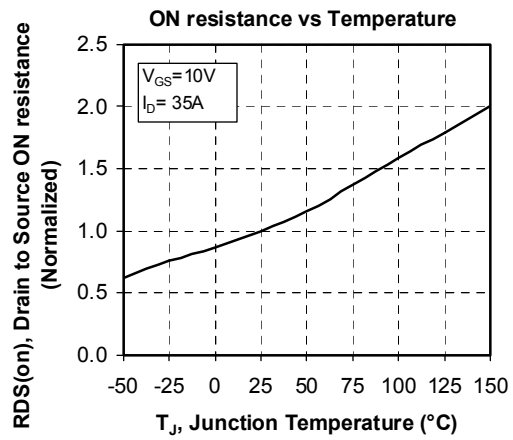

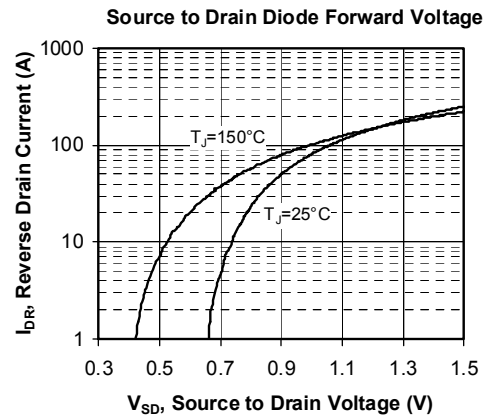
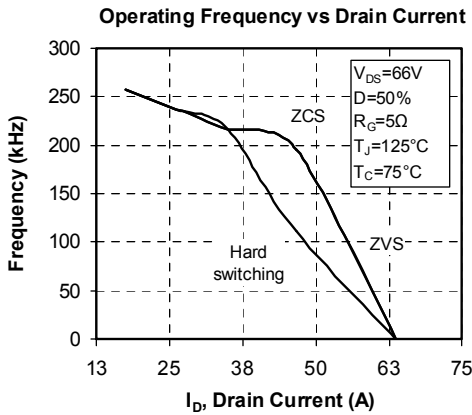
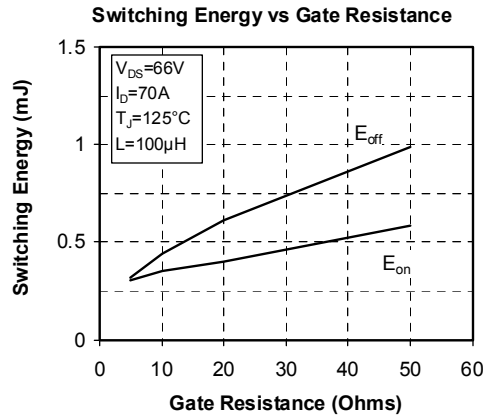
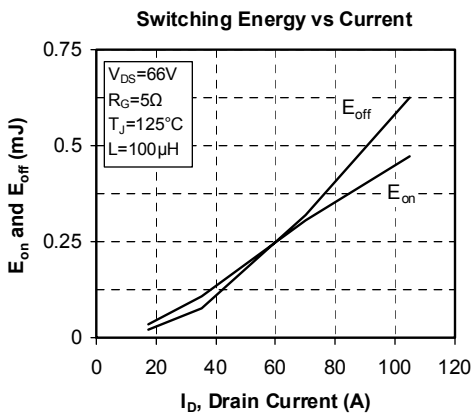
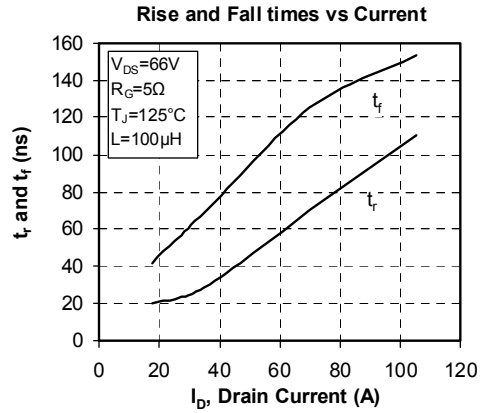
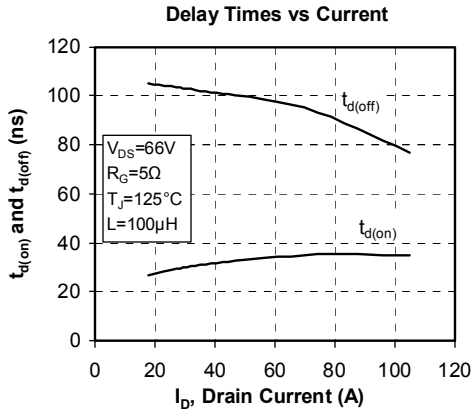

APT reserves the right to change, without notice, the specifications and information contained herein

APT's products are covered by one or more of U.S. patents 4,895,810 5,045,903 5,089,434 5,182,234 5,019,522 5,262,336 6,503,786 5,256,583 4,748,103 5,283,202 5,231,474 5,434,095 5,528,058 and foreign patents. U.S. and Foreign patents pending. All Rights Reserved.