

*Phase leg
with Series diodes
MOSFET Power Module*

**$V_{DSS} = 1200V$
 $R_{DSon} = 200m\Omega \text{ max @ } T_j = 25^\circ C$
 $I_D = 50A \text{ @ } T_c = 25^\circ C$**

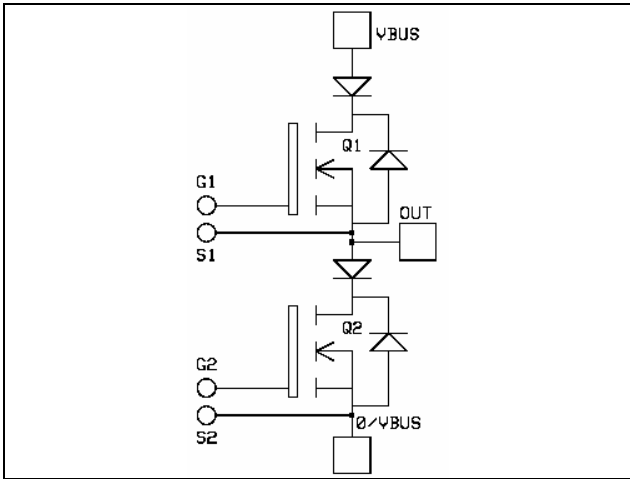

Application

- Zero Current Switching resonant mode

Features

- Power MOS 7[®] MOSFETs
 - Low R_{DSon}
 - Low input and Miller capacitance
 - Low gate charge
 - Fast intrinsic reverse diode
 - Avalanche energy rated
 - Very rugged
- Kelvin source for easy drive
- Very low stray inductance
 - Symmetrical design
 - M5 power connectors
- High level of integration

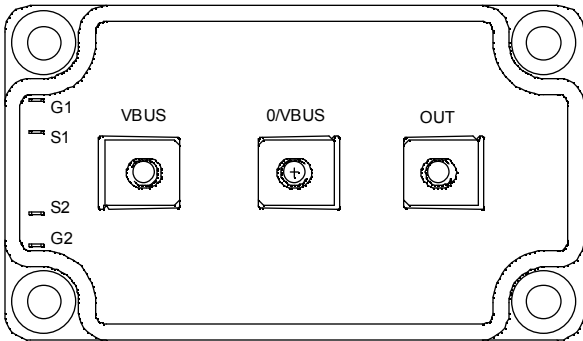

Benefits

- Outstanding performance at high frequency operation
- Direct mounting to heatsink (isolated package)
- Low junction to case thermal resistance
- Low profile

Absolute maximum ratings

Symbol	Parameter	Max ratings	Unit
V_{DSS}	Drain - Source Breakdown Voltage	1200	V
I_D	Continuous Drain Current	$T_c = 25^\circ C$	50
		$T_c = 80^\circ C$	37
I_{DM}	Pulsed Drain current	200	A
V_{GS}	Gate - Source Voltage	± 30	V
R_{DSon}	Drain - Source ON Resistance	200	$m\Omega$
P_D	Maximum Power Dissipation	$T_c = 25^\circ C$	1250
I_{AR}	Avalanche current (repetitive and non repetitive)	12	A
E_{AR}	Repetitive Avalanche Energy	30	mJ
E_{AS}	Single Pulse Avalanche Energy	1300	

CAUTION: These Devices are sensitive to Electrostatic Discharge. Proper Handling Procedures Should Be Followed.

All ratings @ $T_j = 25^\circ\text{C}$ unless otherwise specified

Electrical Characteristics

Symbol	Characteristic	Test Conditions	Min	Typ	Max	Unit
BV_{DSS}	Drain - Source Breakdown Voltage	$V_{GS} = 0V, I_D = 1.5mA$	1200			V
I_{DSS}	Zero Gate Voltage Drain Current	$V_{GS} = 0V, V_{DS} = 1200V$ $T_j = 25^\circ\text{C}$			1.5	mA
		$V_{GS} = 0V, V_{DS} = 1000V$ $T_j = 125^\circ\text{C}$			6	
$R_{DS(on)}$	Drain - Source on Resistance	$V_{GS} = 10V, I_D = 25A$			200	m Ω
$V_{GS(th)}$	Gate Threshold Voltage	$V_{GS} = V_{DS}, I_D = 6mA$	3		5	V
I_{GSS}	Gate - Source Leakage Current	$V_{GS} = \pm 30V, V_{DS} = 0V$			± 450	nA

Dynamic Characteristics

Symbol	Characteristic	Test Conditions	Min	Typ	Max	Unit
C_{iss}	Input Capacitance	$V_{GS} = 0V$ $V_{DS} = 25V$ $f = 1MHz$		15.2		nF
C_{oss}	Output Capacitance			2.2		
C_{rss}	Reverse Transfer Capacitance			0.42		
Q_g	Total gate Charge	$V_{GS} = 10V$ $V_{Bus} = 600V$ $I_D = 50A$		600		nC
Q_{gs}	Gate - Source Charge			84		
Q_{gd}	Gate - Drain Charge			390		
$T_{d(on)}$	Turn-on Delay Time	Inductive switching @ 125°C $V_{GS} = 15V$ $V_{Bus} = 800V$ $I_D = 50A$ $R_G = 0.8\Omega$		10		ns
T_r	Rise Time			10		
$T_{d(off)}$	Turn-off Delay Time			68		
T_f	Fall Time			36		
E_{on}	Turn-on Switching Energy ❶	Inductive switching @ 25°C $V_{GS} = 15V, V_{Bus} = 800V$ $I_D = 50A, R_G = 0.8\Omega$		2.79		mJ
E_{off}	Turn-off Switching Energy ❷			0.6		
E_{on}	Turn-on Switching Energy ❶	Inductive switching @ 125°C $V_{GS} = 15V, V_{Bus} = 800V$ $I_D = 50A, R_G = 0.8\Omega$		5.6		mJ
E_{off}	Turn-off Switching Energy ❷			0.81		

❶ E_{on} includes diode reverse recovery.

❷ In accordance with JEDEC standard JESD24-1.

Series diode ratings and characteristics

Symbol	Characteristic	Test Conditions	Min	Typ	Max	Unit
V_{RRM}	Maximum Repetitive Reverse Voltage		1200			V
$I_{F(AV)}$	Maximum Average Forward Current	50% duty cycle $T_c = 70^\circ\text{C}$		120		A
V_F	Diode Forward Voltage	$I_F = 120A$		2	2.5	V
		$I_F = 2400A$		2.3		
		$I_F = 120A$ $T_j = 125^\circ\text{C}$		1.8		
t_{rr}	Reverse Recovery Time	$I_F = 120A$ $V_R = 800V$ $di/dt = 400A/\mu s$ $T_j = 25^\circ\text{C}$		400		ns
		$T_j = 125^\circ\text{C}$		470		
Q_{rr}	Reverse Recovery Charge	$I_F = 120A$ $V_R = 800V$ $di/dt = 400A/\mu s$ $T_j = 25^\circ\text{C}$		2.4		μC
		$T_j = 125^\circ\text{C}$		8		

Typical Performance Curve

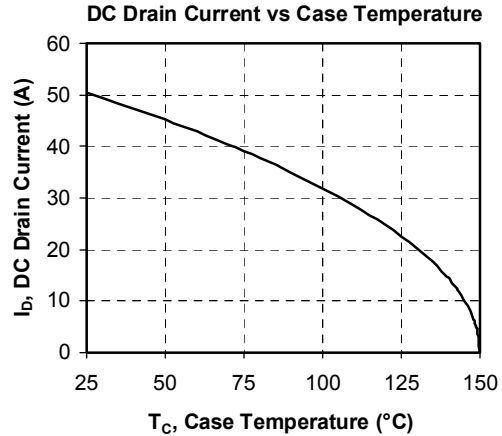
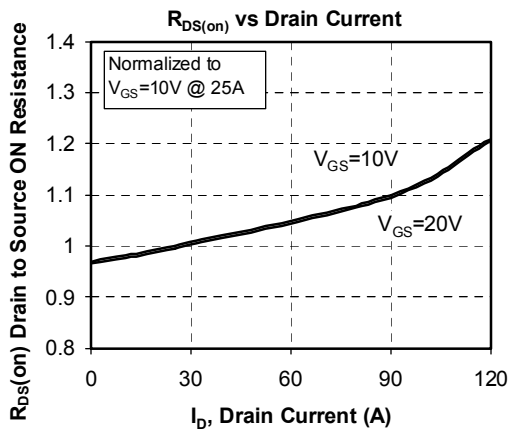
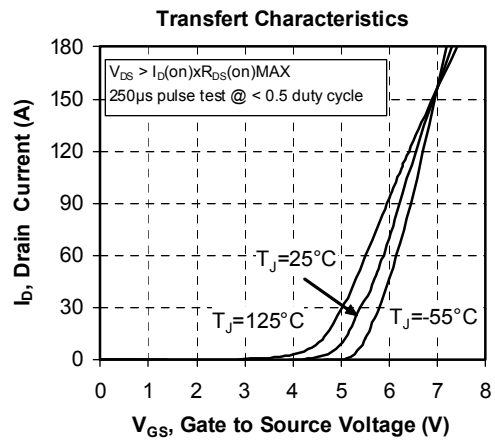
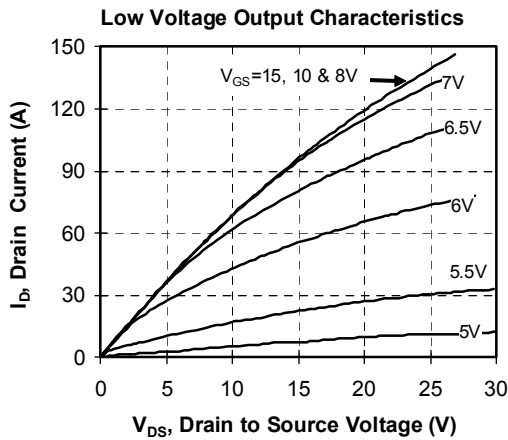
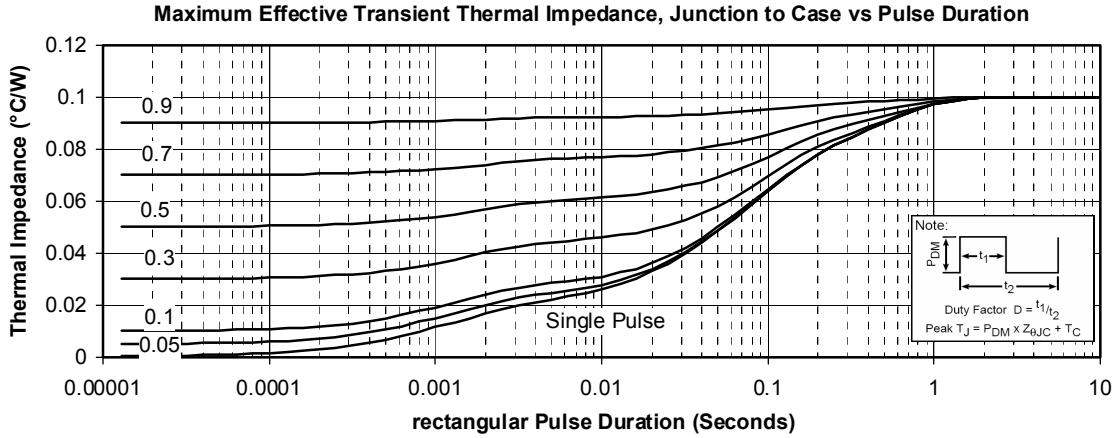

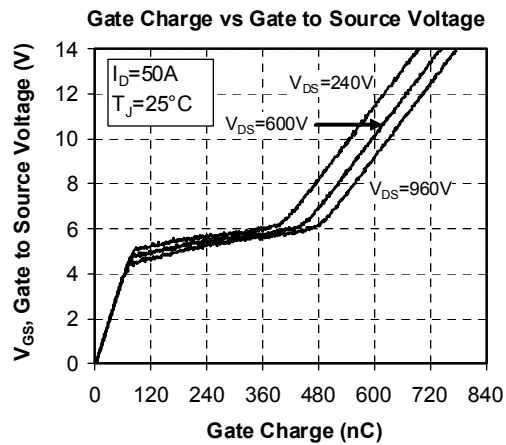
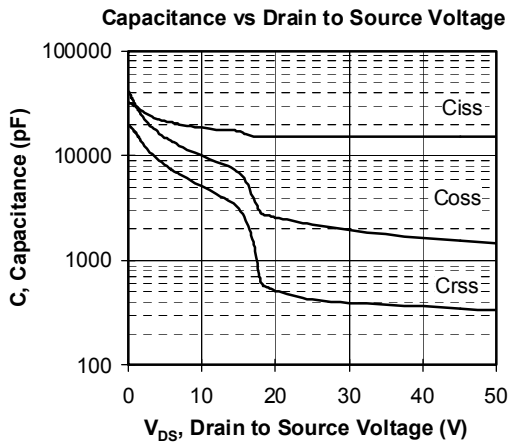
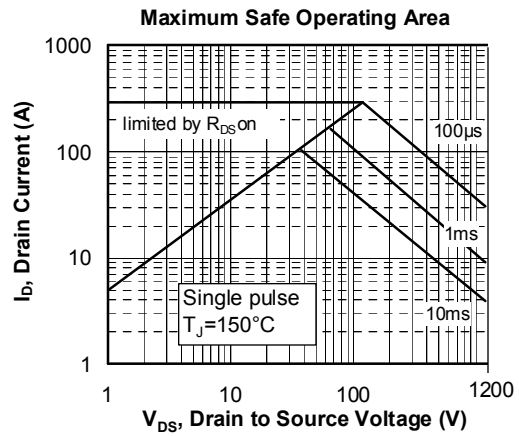
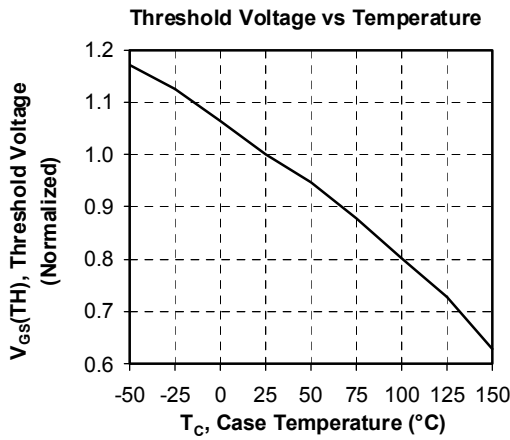
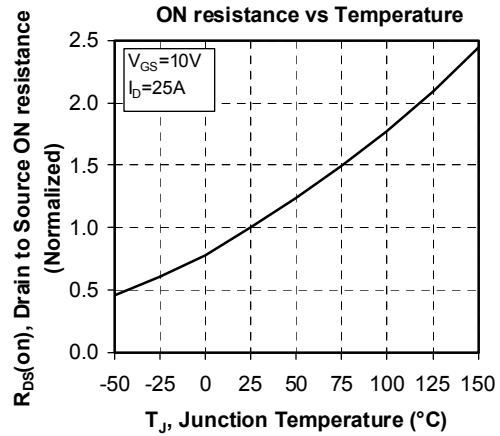
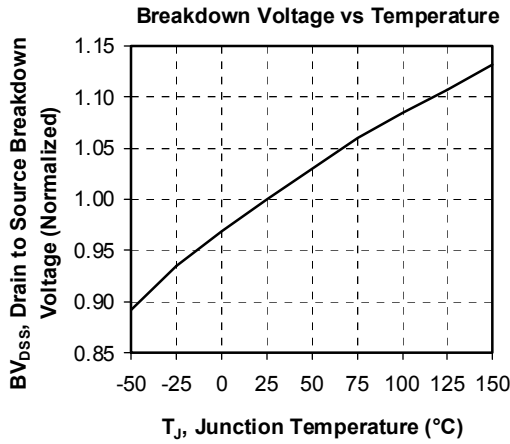

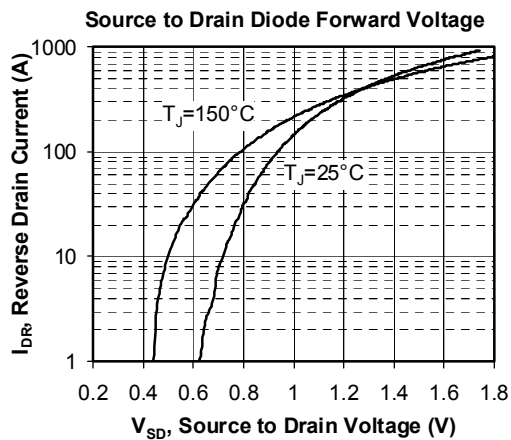
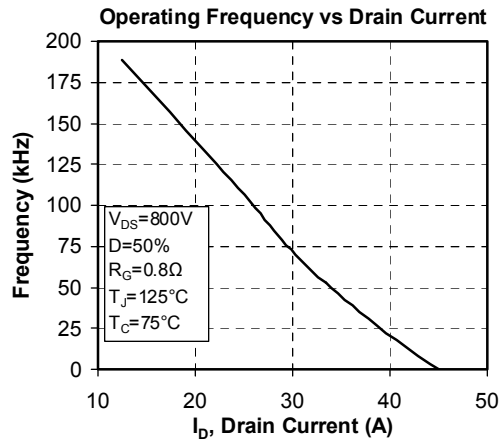
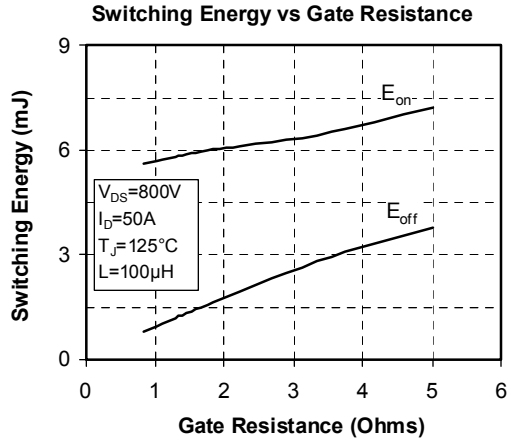
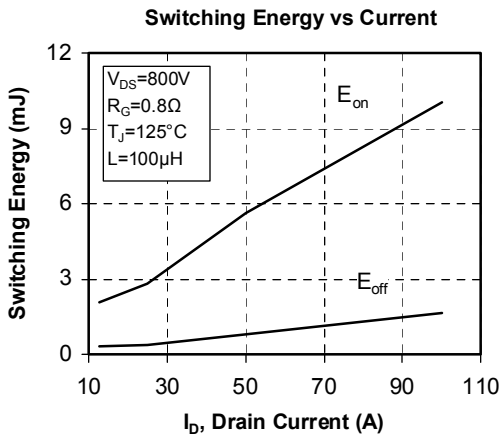
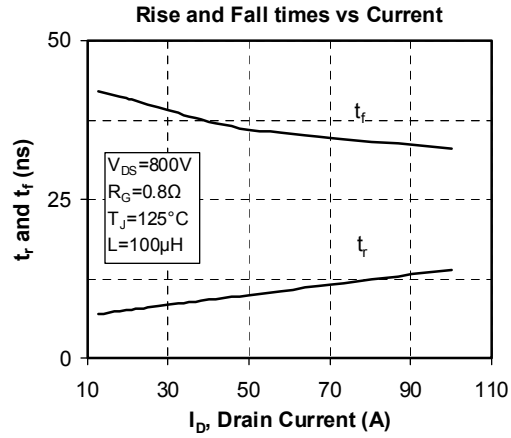
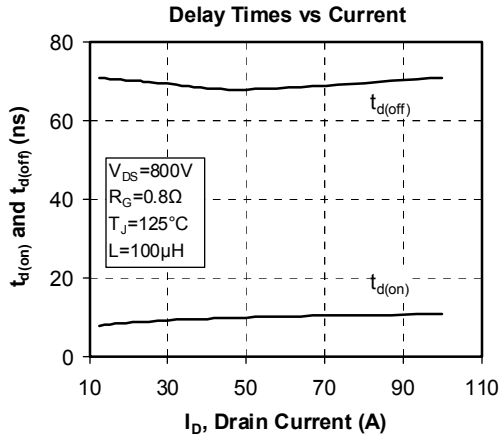

APT reserves the right to change, without notice, the specifications and information contained herein

APT's products are covered by one or more of U.S. patents 4,895,810 5,045,903 5,089,434 5,182,234 5,019,522 5,262,336 6,503,786 5,256,583 4,748,103 5,283,202 5,231,474 5,434,095 5,528,058 and foreign patents. U.S. and Foreign patents pending. All Rights Reserved.