

**Full - Bridge  
MOSFET Power Module**

**$V_{DSS} = 500V$   
 $R_{DSon} = 75m\Omega \text{ max @ } T_j = 25^\circ C$   
 $I_D = 46A \text{ @ } T_c = 25^\circ C$**

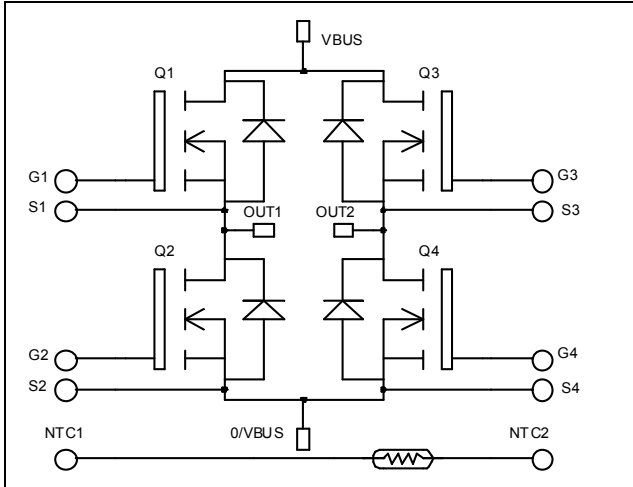

**Application**

- Welding converters
- Switched Mode Power Supplies
- Uninterruptible Power Supplies

**Features**

- Power MOS 7<sup>®</sup> FREDFETs
  - Low  $R_{DSon}$
  - Low input and Miller capacitance
  - Low gate charge
  - Fast intrinsic reverse diode
  - Avalanche energy rated
  - Very rugged
- Kelvin source for easy drive
- Very low stray inductance
  - Symmetrical design
  - Lead frames for power connections
- Internal thermistor for temperature monitoring
- High level of integration

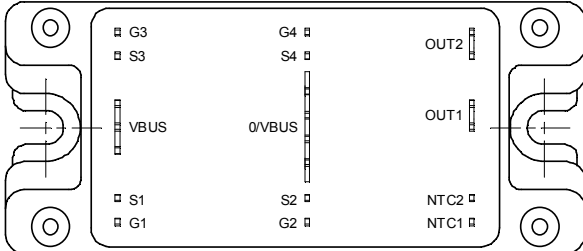

**Benefits**

- Outstanding performance at high frequency operation
- Direct mounting to heatsink (isolated package)
- Low junction to case thermal resistance
- Solderable terminals both for power and signal for easy PCB mounting
- Low profile

**Absolute maximum ratings**

Symbol	Parameter	Max ratings	Unit
$V_{DSS}$	Drain - Source Breakdown Voltage	500	V
$I_D$	Continuous Drain Current	$T_c = 25^\circ C$	46
		$T_c = 80^\circ C$	34
$I_{DM}$	Pulsed Drain current	184	
$V_{GS}$	Gate - Source Voltage	$\pm 30$	V
$R_{DSon}$	Drain - Source ON Resistance	75	$m\Omega$
$P_D$	Maximum Power Dissipation	$T_c = 25^\circ C$	357
$I_{AR}$	Avalanche current (repetitive and non repetitive)	46	A
$E_{AR}$	Repetitive Avalanche Energy	50	mJ
$E_{AS}$	Single Pulse Avalanche Energy	2500	

**CAUTION:** These Devices are sensitive to Electrostatic Discharge. Proper Handling Procedures Should Be Followed.

All ratings @  $T_j = 25^\circ\text{C}$  unless otherwise specified

## Electrical Characteristics

Symbol	Characteristic	Test Conditions	Min	Typ	Max	Unit
$BV_{DSS}$	Drain - Source Breakdown Voltage	$V_{GS} = 0V, I_D = 250\mu A$	500			V
$I_{DSS}$	Zero Gate Voltage Drain Current	$V_{GS} = 0V, V_{DS} = 500V, T_j = 25^\circ\text{C}$			250	$\mu A$
		$V_{GS} = 0V, V_{DS} = 400V, T_j = 125^\circ\text{C}$			1000	
$R_{DS(on)}$	Drain - Source on Resistance	$V_{GS} = 10V, I_D = 23A$			75	$m\Omega$
$V_{GS(th)}$	Gate Threshold Voltage	$V_{GS} = V_{DS}, I_D = 2.5mA$	3		5	V
$I_{GSS}$	Gate - Source Leakage Current	$V_{GS} = \pm 30V, V_{DS} = 0V$			$\pm 100$	nA

## Dynamic Characteristics

Symbol	Characteristic	Test Conditions	Min	Typ	Max	Unit
$C_{iss}$	Input Capacitance	$V_{GS} = 0V, V_{DS} = 25V, f = 1MHz$		5600		pF
$C_{oss}$	Output Capacitance			1200		
$C_{rss}$	Reverse Transfer Capacitance			90		
$Q_g$	Total gate Charge	$V_{GS} = 10V, V_{Bus} = 250V, I_D = 46A$		123		nC
$Q_{gs}$	Gate - Source Charge			33		
$Q_{gd}$	Gate - Drain Charge			65		
$T_{d(on)}$	Turn-on Delay Time	<b>Inductive switching @ 125°C</b> $V_{GS} = 15V, V_{Bus} = 333V, I_D = 46A, R_G = 5\Omega$		18		ns
$T_r$	Rise Time			35		
$T_{d(off)}$	Turn-off Delay Time			87		
$T_f$	Fall Time			77		
$E_{on}$	Turn-on Switching Energy ❶	<b>Inductive switching @ 25°C</b> $V_{GS} = 15V, V_{Bus} = 333V, I_D = 46A, R_G = 5\Omega$		755		$\mu J$
$E_{off}$	Turn-off Switching Energy ❷			726		
$E_{on}$	Turn-on Switching Energy ❶	<b>Inductive switching @ 125°C</b> $V_{GS} = 15V, V_{Bus} = 333V, I_D = 46A, R_G = 5\Omega$		1241		$\mu J$
$E_{off}$	Turn-off Switching Energy ❷			846		

## Source - Drain diode ratings and characteristics

Symbol	Characteristic	Test Conditions	Min	Typ	Max	Unit
$I_S$	Continuous Source current (Body diode)	$T_c = 25^\circ\text{C}$			46	A
		$T_c = 80^\circ\text{C}$			34	
$V_{SD}$	Diode Forward Voltage	$V_{GS} = 0V, I_S = -46A$			1.3	V
dv/dt	Peak Diode Recovery ❸				15	V/ns
$t_{rr}$	Reverse Recovery Time	$I_S = -46A, V_R = 250V, di_S/dt = 100A/\mu s$	$T_j = 25^\circ\text{C}$		233	ns
			$T_j = 125^\circ\text{C}$		499	
$Q_{rr}$	Reverse Recovery Charge	$I_S = -46A, V_R = 250V, di_S/dt = 100A/\mu s$	$T_j = 25^\circ\text{C}$		1.9	$\mu C$
			$T_j = 125^\circ\text{C}$		5.7	

❶  $E_{on}$  includes diode reverse recovery.

❷ In accordance with JEDEC standard JESD24-1.

❸ dv/dt numbers reflect the limitations of the circuit rather than the device itself.

$$I_S \leq -46A \quad di/dt \leq 700A/\mu s \quad V_R \leq V_{DSS} \quad T_j \leq 150^\circ\text{C}$$

**Thermal and package characteristics**

Symbol	Characteristic	Min	Typ	Max	Unit
R <sub>thJC</sub>	Junction to Case			0.35	°C/W
V <sub>ISOL</sub>	RMS Isolation Voltage, any terminal to case t=1 min, I isol<1mA, 50/60Hz	2500			V
T <sub>J</sub>	Operating junction temperature range	-40		150	°C
T <sub>STG</sub>	Storage Temperature Range	-40		125	
T <sub>C</sub>	Operating Case Temperature	-40		100	
Torque	Mounting torque	To Heatsink	M5		4.7 N.m
Wt	Package Weight			160	g

**Temperature sensor NTC**

Symbol	Characteristic	Min	Typ	Max	Unit
R <sub>25</sub>	Resistance @ 25°C		68		kΩ
B <sub>25/85</sub>	T <sub>25</sub> = 298.16 K		4080		K

$$R_T = \frac{R_{25}}{\exp \left[ B_{25/85} \left( \frac{1}{T_{25}} - \frac{1}{T} \right) \right]}$$

T: Thermistor temperature  
R<sub>T</sub>: Thermistor value at T

**Package outline**

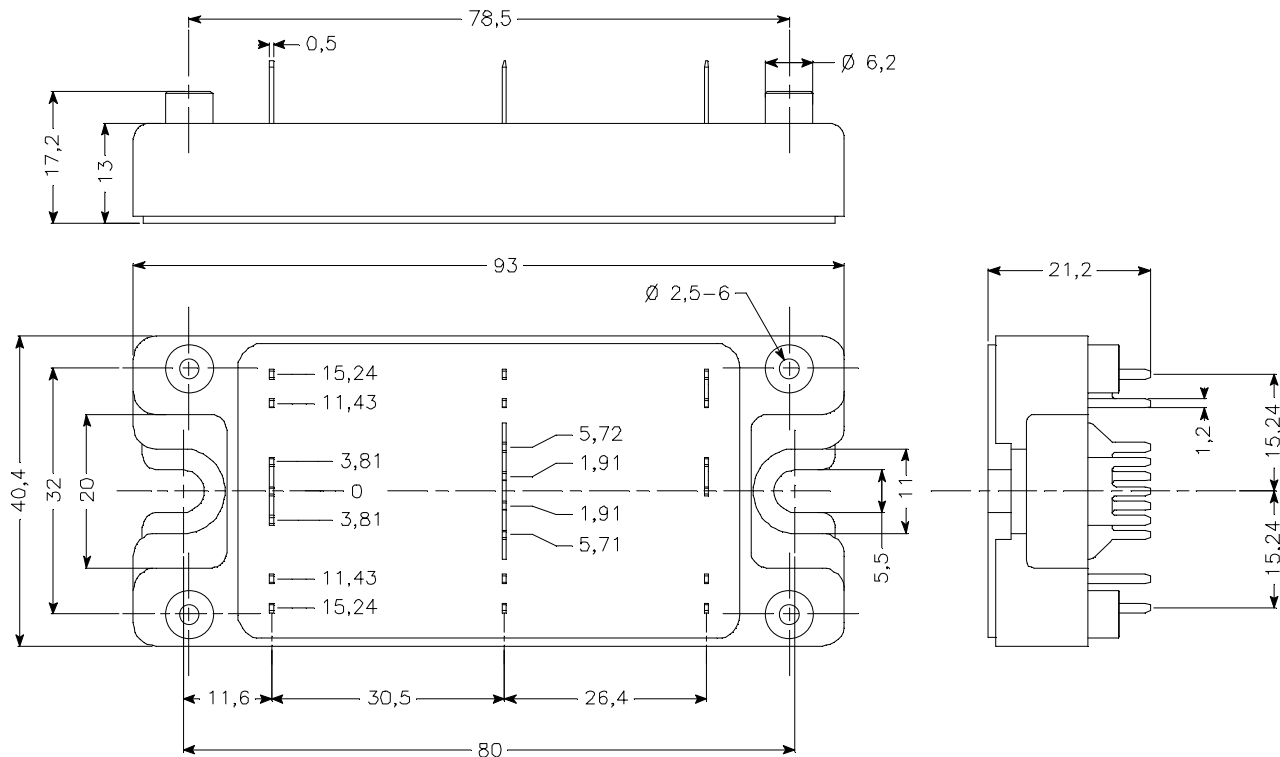

**Typical Performance Curve**

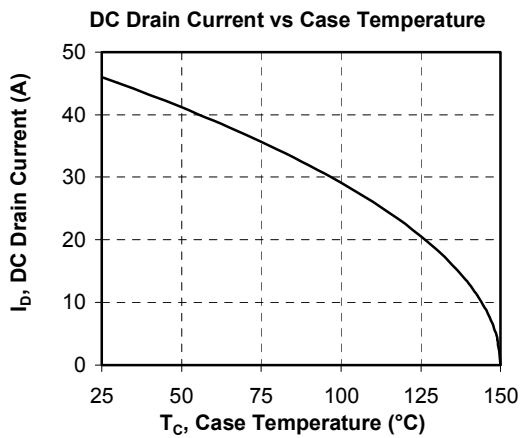
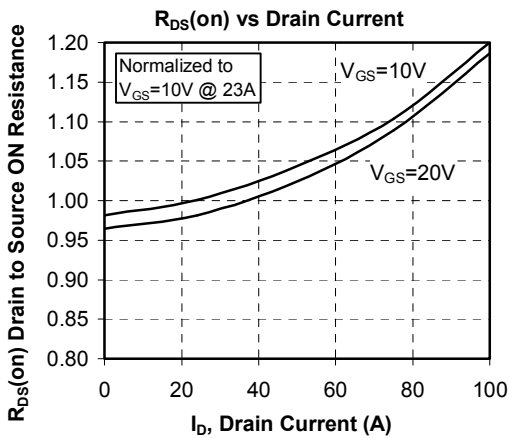
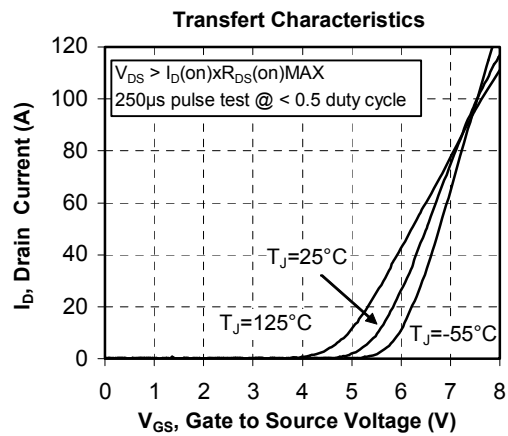
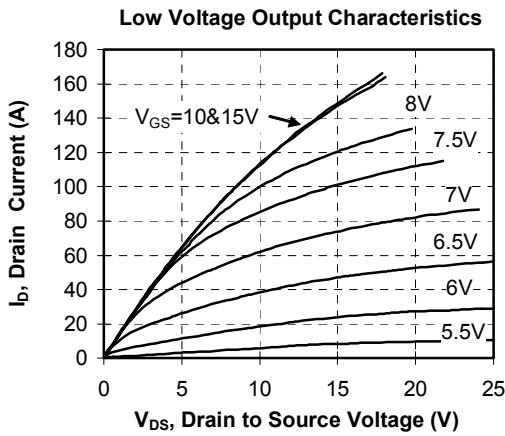
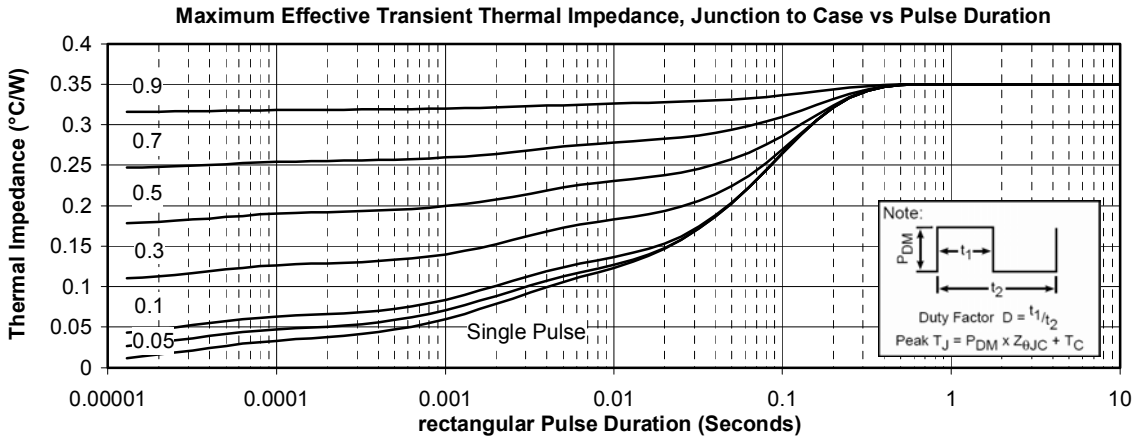

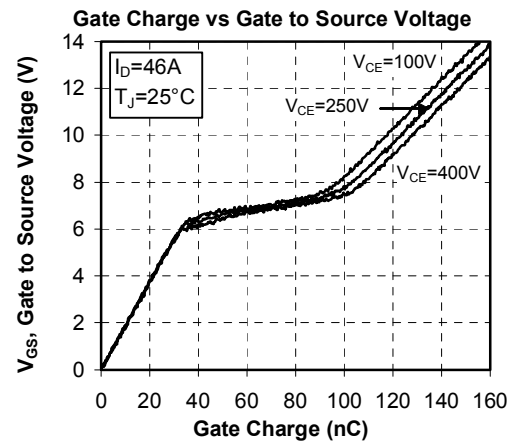
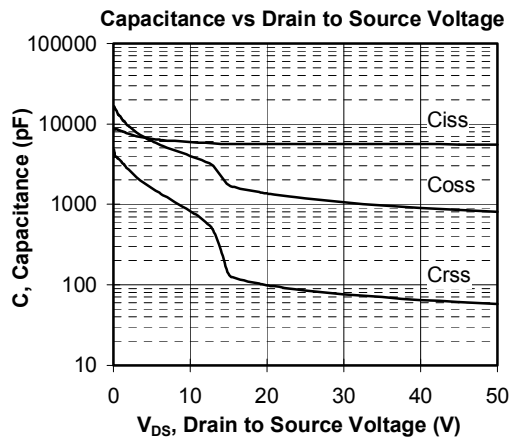
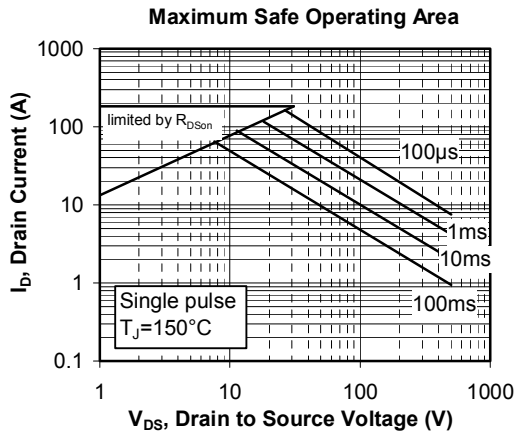
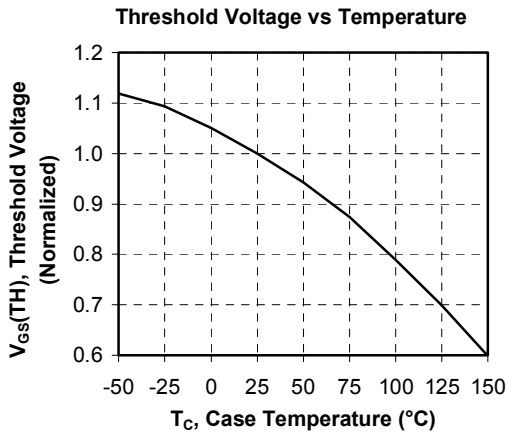
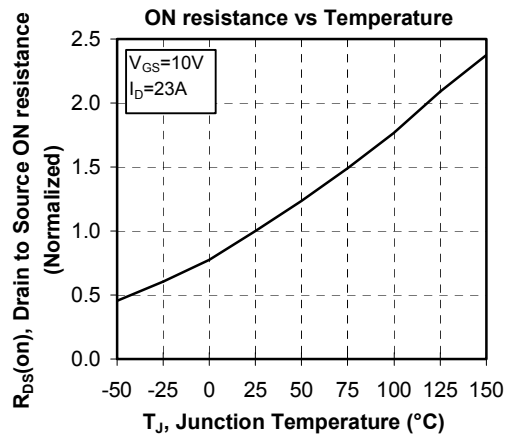
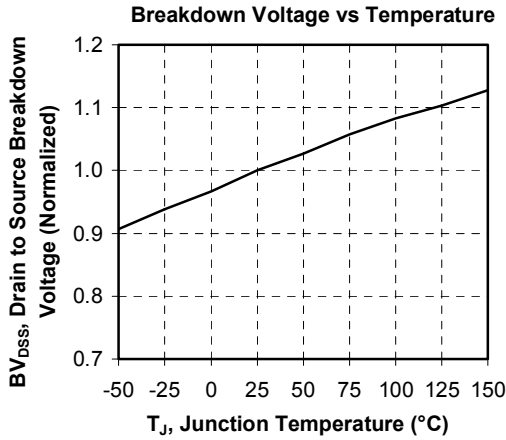

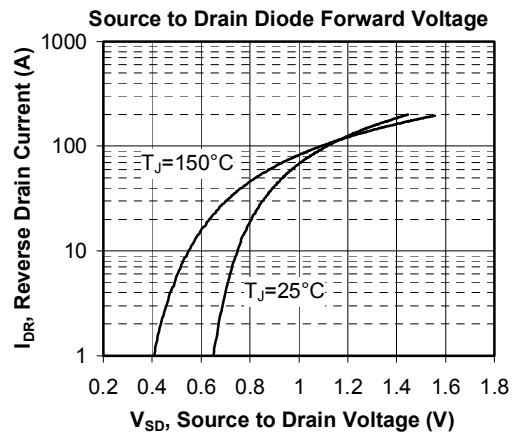
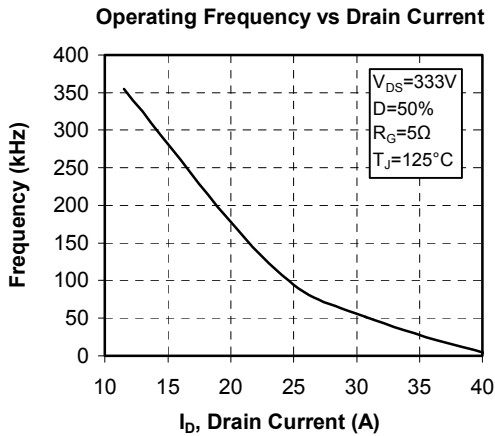
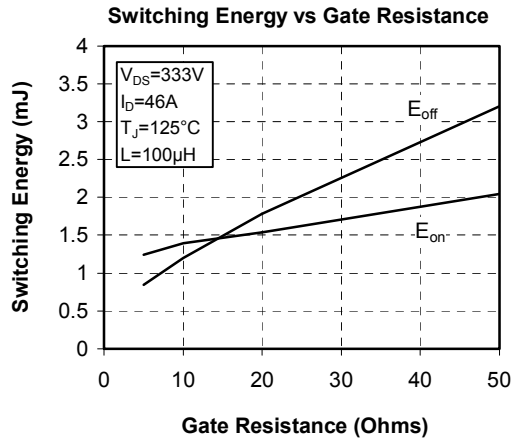
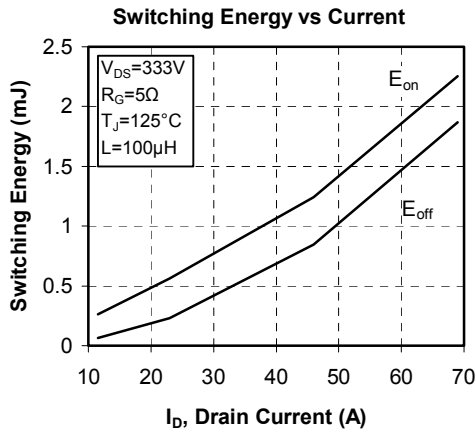
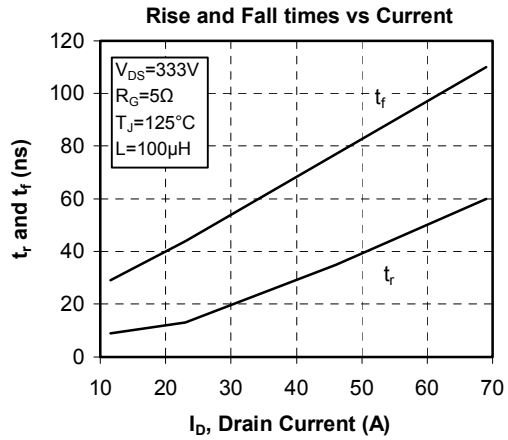
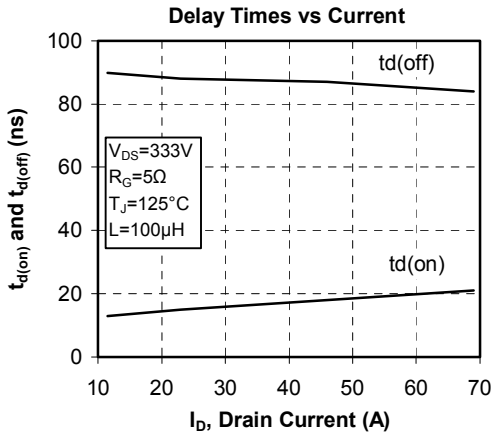

APT reserves the right to change, without notice, the specifications and information contained herein

APT's products are covered by one or more of U.S. patents 4,895,810 5,045,903 5,089,434 5,182,234 5,019,522 5,262,336 6,503,786 5,256,583 4,748,103 5,283,202 5,231,474 5,434,095 5,528,058 and foreign patents. U.S. and Foreign patents pending. All Rights Reserved.