

# GaAs SPDT IC 7 W T/R Switch DC–2.5 GHz



AS216-339

## Features

- T/R Switch
- High Isolation (30 dB @ 0.9 GHz)
- Designed for Mobile Radio Applications
- $P_{-1\text{ dB}} = 10\text{ W @ }0.9\text{ GHz, }25^\circ\text{C}$
- High Intercept Point (IP3 +63 dBm, @ 0.9 GHz)

## Description

The AS216-339 is a high power IC FET SPDT switch in a plastic SOIC-8 exposed paddle package. This switch has been designed for use where extremely high linearity is required. It can be controlled with positive, negative or a combination of both voltages. Some standard implementations include antenna changeover, T/R and diversity switching over 2 W. This switch can be used in many analog and digital wireless communication systems including cellular, GSM and PCS applications.

## SOIC-8 Exposed Paddle

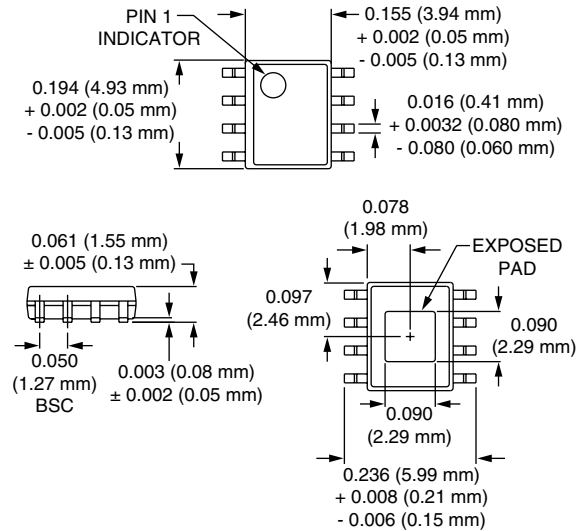

## Electrical Specifications at 25°C (0, -5 V)

Parameter <sup>1</sup>	Frequency <sup>2</sup>	Min.	Typ.	Max.	Unit
Insertion Loss <sup>3</sup>	DC–0.5 GHz		0.7	0.8	dB
	DC–1.0 GHz		0.8	0.9	dB
	DC–2.5 GHz		1.0	1.1	dB
Isolation	DC–0.5 GHz	32	34		dB
	DC–1.0 GHz	27	28		dB
	DC–2.5 GHz	19	20		dB
VSWR <sup>4</sup>	DC–1.0 GHz		1.2:1	1.4:1	dB
	DC–2.5 GHz		1.5:1	1.7:1	dB

## Operating Characteristics at 25°C (0, -5 V)

Parameter	Condition	Frequency	Min.	Typ.	Max.	Unit
Switching Characteristics <sup>5</sup>	Rise, Fall (10/90% or 90/10% RF)			6		ns
	On, Off (50% CTL to 90/10% RF)			12		ns
	Video Feedthru			30		mV
Input Power for 1 dB Compression	5 V	0.9 GHz		+35		dBm
	10 V	0.9 GHz		+40		dBm
Intermodulation Intercept Point	For Two-tone Input Power +13 dBm IP3	0.9 GHz		+63		dBm
Control Voltages	$V_{\text{Low}} = -12.0\text{ V} \leq V_{\text{Low}} \leq 0\text{ V, }500\ \mu\text{A Max.}$ $V_{\text{High}} = 0\text{ V} \leq V_{\text{High}} \leq +12.0\text{ V, }500\ \mu\text{A Max.}$ Differential = $+5.0\text{ V} \leq (V_{\text{High}} - V_{\text{Low}}) < +12.0\text{ V}$					

1. All measurements made in a 50 Ω system, unless otherwise specified.
2. DC = 300 kHz.
3. Insertion loss changes by 0.003 dB/°C.
4. Insertion loss state.
5. Video feedthru measured with 1 ns risetime pulse and 500 MHz bandwidth.

**Typical Performance Data (0, -5 V)**

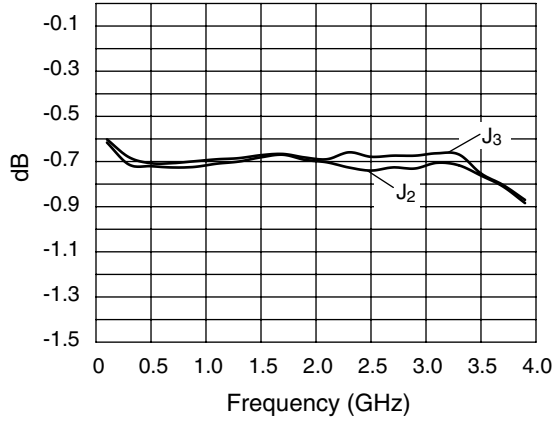

**Insertion Loss vs. Frequency**

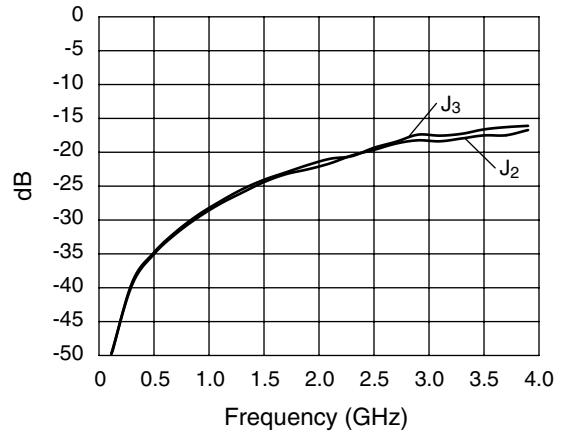

**Typical Insertion Loss vs. Frequency**

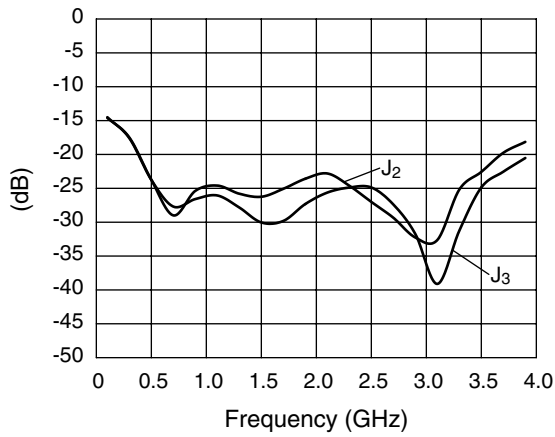

**Typical Return Loss vs. Frequency**

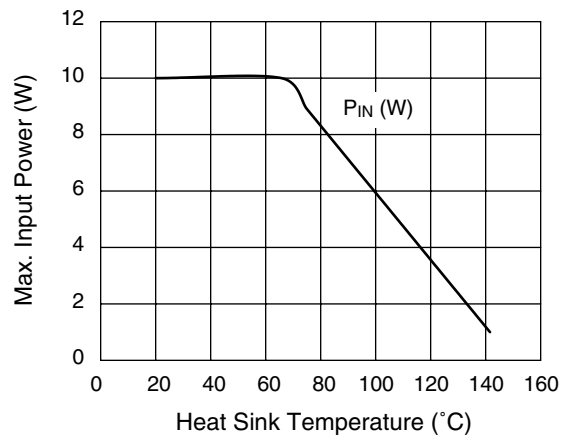

**Temperature Derating Curve (0, +10)**

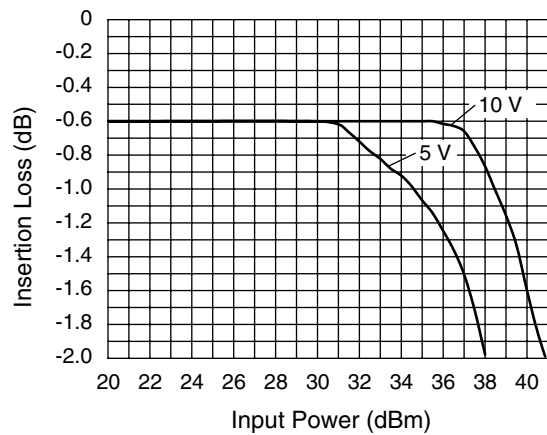

**Compression at 900 MHz 25°C**

**Absolute Maximum Ratings**

Characteristic	Value
RF Input Power	8 W > 0.9 GHz, 0, -12 V
Control Voltage	$(V_{High} - V_{Low}) < 12 V$
Operating Temperature	-40°C to +85°C
Storage Temperature	-65°C to +150°C
$\theta_{JC}$	45°C/W

**Truth Table**

V <sub>1</sub>	V <sub>2</sub>	J <sub>1</sub> -J <sub>2</sub>	J <sub>1</sub> -J <sub>3</sub>
V <sub>Low</sub>	V <sub>High</sub>	Insertion Loss	Isolation
V <sub>High</sub>	V <sub>Low</sub>	Isolation	Insertion Loss

V<sub>Low</sub> = 0 to -12.0 V.  
 V<sub>High</sub> = 0 to +12.0 V.  
 Differential = +5.0 V ≤ (V<sub>High</sub> - V<sub>Low</sub>) < +12.0 V.  
 Refer to Application Notes for further information on differential voltage operation.

**Pin Out**

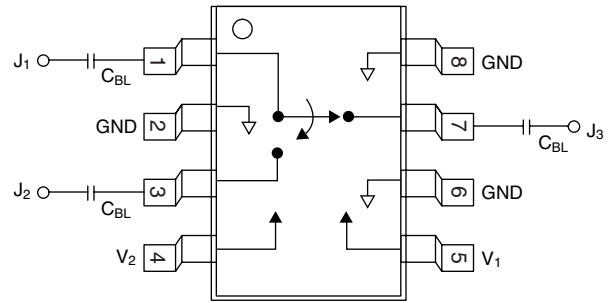

External DC blocking capacitors (C<sub>BL</sub>) are required only if V<sub>High</sub> > 0.0 V.  
 C<sub>BL</sub> = 100 pF for operation >500 MHz.