

SIKOREL® 105

Long-life grade capacitors

Applications

- Highly professional power supplies

Features

- Maximum reliability
- Operation at temperatures up to 125 °C permissible without insulating sleeve¹⁾
- High ripple current capability
- Long useful life
- Shelf life up to 10 years
- All-welded construction ensures reliable electrical contact

Construction

- Charge-discharge proof, polar
- Aluminum case with insulating sleeve
- Poles with screw terminal connections
- Mounting with ring clips, clamps or threaded stud
- The bases of types with threaded stud are not insulated

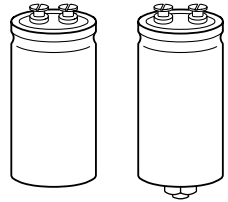

B41550

B41570

1) For $\varnothing \leq 51,6$ mm: 2500 h, for $\varnothing \geq 64,3$ mm: 5000 h

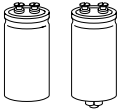

Specifications and characteristics in brief

Rated voltage U_R	16 ... 100 VDC	
Surge voltage U_S	$1,15 \cdot U_R$	
Rated capacitance C_R	1 500 ... 220 000 μ F	
Capacitance tolerance	– 10/+ 30 % \triangle Q	
Leakage current I_L (5 min, 20 °C)	$I_L \leq 0,3 \mu\text{A} \cdot \left(\frac{C_R}{\mu\text{F}} \cdot \frac{U_R}{\text{V}}\right)^{0,7} + 4 \mu\text{A}$	
Self-inductance ESL	$d = 35,7 \text{ mm}$: approx. 10 nH $d = 51,6 \text{ mm}$: approx. 15 nH $d \geq 64,3 \text{ mm}$: approx. 20 nH	
Useful life	$d \leq 51,6 \text{ mm}$	$d \geq 64,3 \text{ mm}$
105 °C; U_R ; I_{-R}	> 10 000 h	> 20 000 h
85 °C; U_R ; I_{-max}	> 15 000 h	> 25 000 h
40 °C; U_R ($2,4 \cdot I_{-R}$)	> 200 000 h	–
40 °C; U_R ($2,7 \cdot I_{-R}$)	–	> 200 000 h
	Requirements: $\Delta C/C$ $\leq \pm 45$ % of initial value ESR ≤ 3 times initial specified limit I_L \leq initial specified limit Failure percentage: ≤ 1 % Failure rate: ≤ 20 fit ($\leq 20 \cdot 10^{-9}/\text{h}$) (for definition "fit", refer to chapter "Quality", page 62)	
Voltage endurance test	5 000 h	
105 °C; U_R ; I_{-R}	Post test requirements: $\Delta C/C$ $\leq \pm 15$ % of initial value ESR $\leq 1,3$ times initial specified limit I_L \leq initial specified limit	
Vibration resistance	To IEC 60068-2-6, test Fc: displacement amplitude 0,75 mm, frequency range 10 to 55 Hz, acceleration max. 10 g, duration 3×2 h	
IEC climatic category	To IEC 60068-1: 55/105/56 (– 55 °C/+ 105 °C/56 days damp heat test)	
Detail specification	Similar to CECC 30301-804	
Sectional specification	IEC 60384-4	

Ripple current capability

Due to the ripple current capability of the contact elements, the following current upper limits must not be exceeded:

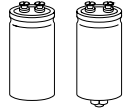
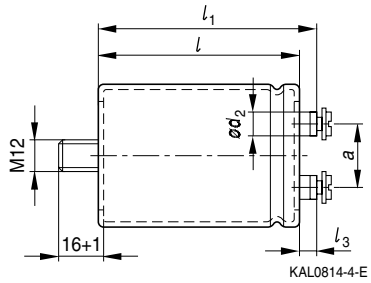
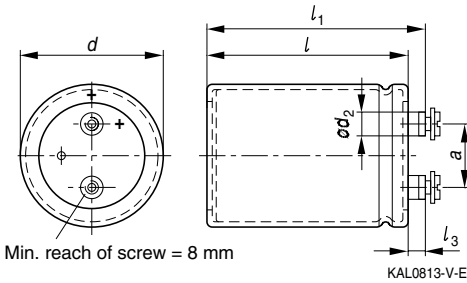
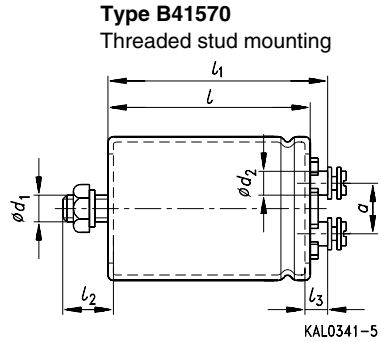
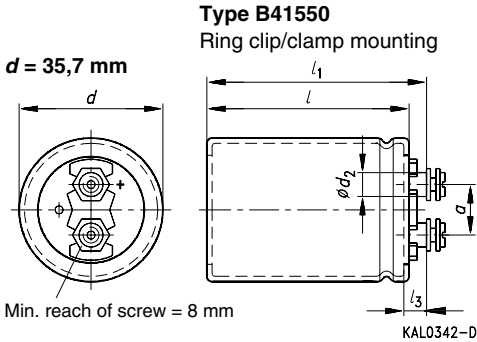
Capacitor diameter	$\leq 51,6 \text{ mm}$	$> 51,6 \text{ mm}$
I_{-max}	30 A	40 A

Dimensional drawings

Positive pole marking: +

Dimensions and weights

Ter- minal	Dimensions (mm) with insulating sleeve						Approx.		
	d	$l \pm 1$	$l_1 \pm 1$	$l_2^{+0}_{-1}$	l_3	d_1	$d_2 \text{ max}$	$a^{+0,2}_{-0,4}$	wt. (g)
M 5	35,7+ 0/-0,8	55,7	62,0	13	7,0+ 0,2/-1	M 8	8,2	12,7	65
M 5	35,7+ 0/-0,8	80,7	87,0	13	7,0+ 0,2/-1	M 8	8,2	12,7	105
M 5	35,7+ 0/-0,8	105,7	112,0	13	7,0+ 0,2/-1	M 8	8,2	12,7	135
M 5	51,6+ 0/-0,8	80,7	87,0	17	7,0+ 0,2/-1	M 12	8,2	22,2	220
M 5	64,3+ 0/-0,8	80,7	87,0	17	7,0+ 0,2/-1	M 12	8,2	28,5	345
M 5	64,3+ 0/-0,8	105,7	112,0	17	7,0+ 0,2/-1	M 12	8,2	28,5	440
M 5	76,9+ 0/-0,7	105,7	112,0	17	7,0+ 0,2/-1	M 12	8,2	31,7	540
M 5	76,9+ 0/-0,7	143,2	149,5	17	7,0+ 0,2/-1	M 12	8,2	31,7	840

Packing (For ecological reasons the packing is pure cardboard.)

Capacitor diameter d	Packing units (pieces)	Capacitor diameter d	Packing units (pieces)
35,7 mm	36	64,3 mm	15
51,6 mm	22	76,9 mm	12

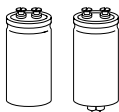
B41550 / B41570
SIKOREL – 105 °C
Accessories

The following items are included in the delivery package, but are not fastened to the capacitors:

	Thread	Toothed washers	Screws/Nuts	Maximum torque
For terminals	M 5	A 5,1 DIN 6797	Cylinder-head screw M 5 × 8 DIN 84-4.8	2 Nm
For mounting	M 8	J 8,2 DIN 6797	Hex nut BM 8 DIN 439	4 Nm
	M 12	J 12,5 DIN 6797	Hex nut BM 12 DIN 439	10 Nm

The following must be ordered separately:

Ring clips

B44030 (cf. page 169)

Clamps for capacitors with $d \geq 64,3$ mm

B44030 (cf. page 173)

Insulating parts

B44020 (cf. page 166)

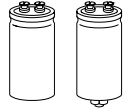
Overview of available types

U_R (VDC)	16	25	40	63	100
C_R (μ F)	Case dimensions $d \times l$ (mm)				
1 500					35,7 × 55,7
2 200				35,7 × 55,7	35,7 × 80,7
3 300				35,7 × 80,7	35,7 × 105,7
4 700			35,7 × 55,7	35,7 × 80,7	51,6 × 80,7
6 800		35,7 × 55,7	35,7 × 80,7	35,7 × 105,7	64,3 × 80,7
10 000	35,7 × 55,7	35,7 × 80,7	35,7 × 80,7	51,6 × 80,7	64,3 × 80,7
15 000	35,7 × 80,7	35,7 × 80,7	35,7 × 105,7	64,3 × 80,7	64,3 × 105,7
22 000	35,7 × 80,7	35,7 × 105,7	51,6 × 80,7	64,3 × 105,7	76,9 × 105,7
33 000	35,7 × 105,7	51,6 × 80,7	64,3 × 80,7	76,9 × 105,7	76,9 × 143,2
47 000	51,6 × 80,7	64,3 × 80,7	64,3 × 105,7	76,9 × 143,2	
68 000	64,3 × 80,7	64,3 × 105,7	76,9 × 105,7		
100 000	64,3 × 105,7	76,9 × 105,7	76,9 × 143,2		
150 000	76,9 × 105,7	76,9 × 143,2			
220 000	76,9 × 143,2				

The capacitance and voltage ratings listed above are available in different cases upon request.

Other voltage and capacitance ratings are also available upon request.

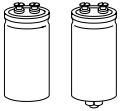

B41550 / B41570

SIKOREL – 105 °C

Technical data and ordering codes

U_R	C_R 100 Hz 20 °C μF	Case dimensions $d \times l$ mm	ESR_{max} 100 Hz 20 °C mΩ	Z_{max} 10 kHz 20 °C mΩ	$I_{~max}$ 100 Hz 40 °C A	$I_{~max}$ 100 Hz 85 °C A	$I_{~R}$ 100 Hz 105 °C A	Ordering code ¹⁾
16	10 000	35,7 × 55,7	38	26	17	12	6,2	B415*0E4109Q000
	15 000	35,7 × 80,7	26	21	23	16	8,1	B415*0E4159Q000
	22 000	35,7 × 80,7	21	18	29	21	10	B415*0E4229Q000
	33 000	35,7 × 105,7	17	15	30	24	12	B415*0E4339Q000
	47 000	51,6 × 80,7	13	13	30	30	16	B415*0E4479Q000
	68 000	64,3 × 80,7	13	11	40	38	17	B415*0E4689Q000
	100 000	64,3 × 105,7	10	9,0	40	39	19	B415*0E4100Q000
	150 000	76,9 × 105,7	10	8,0	40	40	22	B415*0E4150Q000
	220 000	76,9 × 143,2	8,0	7,0	40	40	26	B415*0A4220Q000
25	6 800	35,7 × 55,7	32	27	18	13	6,4	B415*0A5688Q000
	10 000	35,7 × 80,7	28	21	21	15	7,5	B415*0E5109Q000
	15 000	35,7 × 80,7	24	17	26	19	9,4	B415*0E5159Q000
	22 000	35,7 × 105,7	20	15	30	22	11	B415*0E5229Q000
	33 000	51,6 × 80,7	15	12	30	29	15	B415*0E5339Q000
	47 000	64,3 × 80,7	13	11	40	34	17	B415*0E5479Q000
	68 000	64,3 × 105,7	11	9,0	40	35	17	B415*0E5689Q000
	100 000	76,9 × 105,7	9,0	8,0	40	39	21	B415*0E5100Q000
	150 000	76,9 × 143,2	7,0	6,0	40	40	26	B415*0A5150Q000
40	4 700	35,7 × 55,7	33	24	20	14	7,2	B415*0E7478Q000
	6 800	35,7 × 80,7	28	17	24	16	8,4	B415*0A7688Q000
	10 000	35,7 × 80,7	27	14	26	19	9,4	B415*0E7109Q000
	15 000	35,7 × 105,7	20	12	30	22	11	B415*0E7159Q000
	22 000	51,6 × 80,7	15	12	30	29	15	B415*0E7229Q000
	33 000	64,3 × 80,7	13	10	40	34	17	B415*0E7339Q000
	47 000	64,3 × 105,7	12	9,0	40	35	17	B415*0E7479Q000
	68 000	76,9 × 105,7	9,0	7,0	40	39	21	B415*0E7689Q000
		100 000	76,9 × 143,2	7,0	6,0	40	40	26

1) * "5" = for capacitors with ring clip/clamp mounting
 "7" = for capacitors with threaded stud

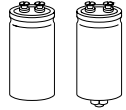
Technical data and ordering codes

U_R	C_R	Case dimensions $d \times l$ mm	ESR_{max} 100 Hz 20 °C mΩ	Z_{max} 10 kHz 20 °C mΩ	$I_{\sim max}$ 100 Hz 40 °C A	$I_{\sim max}$ 100 Hz 85 °C A	$I_{\sim R}$ 100 Hz 105 °C A	Ordering code ¹⁾
VDC	μF							
63	2 200	35,7 × 55,7	60	30	13	9,4	4,7	B415*0E8228Q000
	3 300	35,7 × 80,7	39	24	19	14	6,8	B415*0E8338Q000
	4 700	35,7 × 80,7	31	20	24	17	8,7	B415*0E8478Q000
	6 800	35,7 × 105,7	23	17	28	20	10	B415*0E8688Q000
	10 000	51,6 × 80,7	18	14	30	27	13	B415*0E8109Q000
	15 000	64,3 × 80,7	15	11	40	31	15	B415*0E8159Q000
	22 000	64,3 × 105,7	12	9,0	40	35	17	B415*0E8229Q000
	33 000	76,9 × 105,7	9,0	8,0	40	39	21	B415*0E8339Q000
	47 000	76,9 × 143,2	7,0	6,0	40	40	26	B415*0A8479Q000
100	1 500	35,7 × 55,7	83	34	12	8,8	4,2	B415*0A9158Q000
	2 200	35,7 × 80,7	57	30	16	12	5,9	B415*0E9228Q000
	3 300	35,7 × 105,7	37	24	22	16	8,0	B415*0E9338Q000
	4 700	51,6 × 80,7	29	20	28	20	10	B415*0E9478Q000
	6 800	64,3 × 80,7	22	17	36	26	13	B415*0E9688Q000
	10 000	64,3 × 80,7	15	14	40	32	16	B415*0E9109Q000
	15 000	64,3 × 105,7	13	11	40	36	18	B415*0E9159Q000
	22 000	76,9 × 105,7	11	9,0	40	38	19	B415*0A9229Q000
	33 000	76,9 × 143,2	9,0	8,0	40	40	23	B415*0A9339Q000

1) * "5" = for capacitors with ring clip/clamp mounting
 "7" = for capacitors with threaded stud

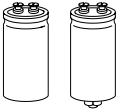

B41550 / B41570

SIKOREL – 105 °C

Useful life

depending on ambient temperature T_A under ripple current operating conditions¹⁾

$d \leq 51,6 \text{ mm}$

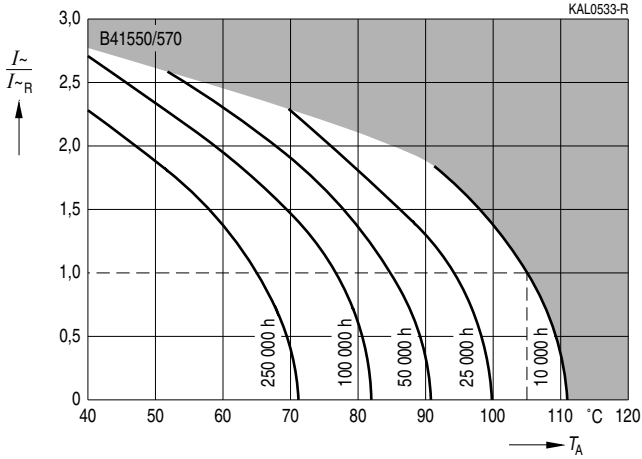

$d \geq 64,3 \text{ mm}$

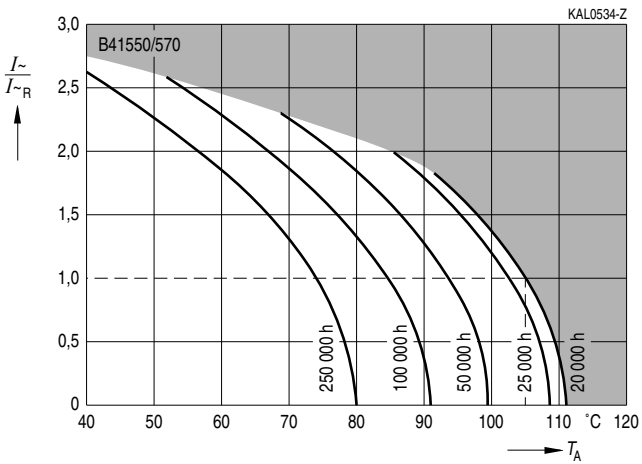

1) Refer to page 40 for an explanation on how to interpret the useful life graphs.

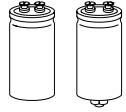

Frequency factor of permissible ripple current I_{\sim} versus frequency f

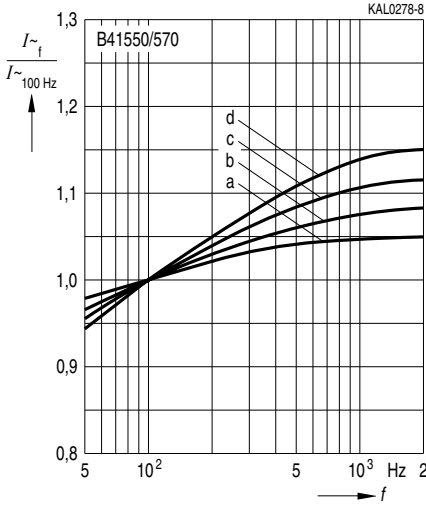

U_R (VDC)	16; 25	40	63	100
$d = 35,7$ mm	b	c	d	d
$d = 51,6$ mm	a	b	c	c
$d = 64,3$ mm	a	a	c	c
$d = 76,9$ mm	a	a	b	c

Frequency characteristics of ESR
Typical behavior

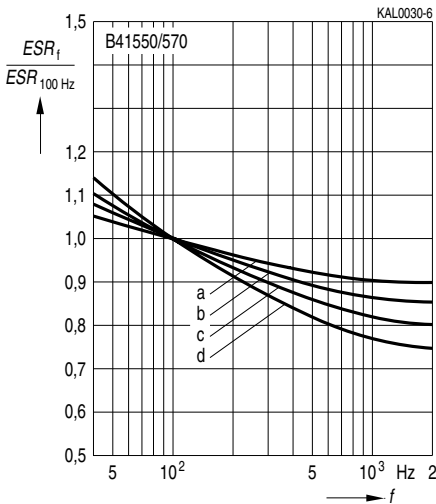

U_R (VDC)	16; 25	40	63	100
$d = 35,7$ mm	b	c	d	d
$d = 51,6$ mm	a	b	c	c
$d = 64,3$ mm	a	a	c	c
$d = 76,9$ mm	a	a	b	c

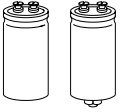

B41550 / B41570

SIKOREL – 105 °C

Impedance Z

versus frequency f

Typical behavior at 20 °C

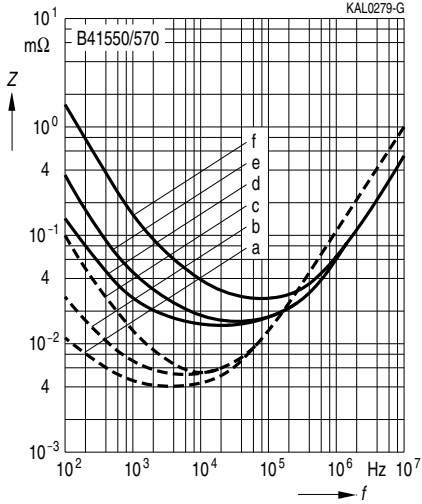

C_R μF	U_R VDC	d mm	Curve
150 000	16	76,9	a
68 000	40		b
15 000	100	64,3	c
10 000	16		d
4 700	40	35,7	e
1 500	100		f

Herausgegeben von EPCOS AG

Unternehmenskommunikation, Postfach 80 17 09, 81617 München, DEUTSCHLAND

☎ ++49 89 636 09, FAX (0 89) 636-2 26 89

© EPCOS AG 2002. Vervielfältigung, Veröffentlichung, Verbreitung und Verwertung dieser Broschüre und ihres Inhalts ohne ausdrückliche Genehmigung der EPCOS AG nicht gestattet.

Bestellungen unterliegen den vom ZVEI empfohlenen Allgemeinen Lieferbedingungen für Erzeugnisse und Leistungen der Elektroindustrie, soweit nichts anderes vereinbart wird.

Diese Broschüre ersetzt die vorige Ausgabe.

Fragen über Technik, Preise und Liefermöglichkeiten richten Sie bitte an den Ihnen nächstgelegenen Vertrieb der EPCOS AG oder an unsere Vertriebsgesellschaften im Ausland. Bauelemente können aufgrund technischer Erfordernisse Gefahrstoffe enthalten. Auskünfte darüber bitten wir unter Angabe des betreffenden Typs ebenfalls über die zuständige Vertriebsgesellschaft einzuholen.

Published by EPCOS AG

Corporate Communications, P.O. Box 80 17 09, 81617 Munich, GERMANY

☎ ++49 89 636 09, FAX (0 89) 636-2 26 89

© EPCOS AG 2002. Reproduction, publication and dissemination of this brochure and the information contained therein without EPCOS' prior express consent is prohibited.

Purchase orders are subject to the General Conditions for the Supply of Products and Services of the Electrical and Electronics Industry recommended by the ZVEI (German Electrical and Electronic Manufacturers' Association), unless otherwise agreed.

This brochure replaces the previous edition.

For questions on technology, prices and delivery please contact the Sales Offices of EPCOS AG or the international Representatives.

Due to technical requirements components may contain dangerous substances. For information on the type in question please also contact one of our Sales Offices.