

### on-chip resistor NPN silicon epitaxial transistor For mid-speed switching

#### FEATURES

- On-chip bias resistor  
( $R_1 = 4.7 \text{ k}\Omega$ ,  $R_2 = 10 \text{ k}\Omega$ )
- Complementary transistor with BN1L3N

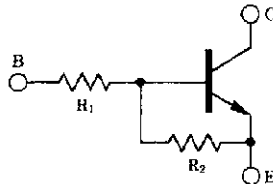

#### PACKAGE DRAWING (UNIT: mm)

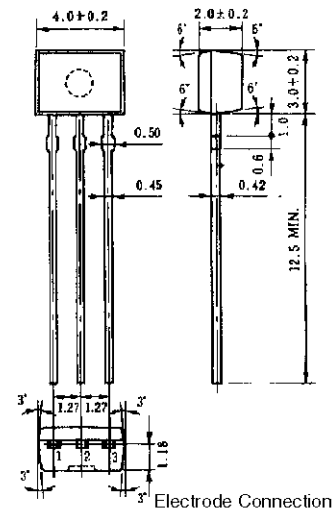

#### ABSOLUTE MAXIMUM RATINGS ( $T_a = 25^\circ\text{C}$ )

Parameter	Symbol	Ratings	Unit
Collector to base voltage	$V_{CBO}$	60	V
Collector to emitter voltage	$V_{CEO}$	50	V
Emitter to base voltage	$V_{EBO}$	5	V
Collector current (DC)	$I_{C(DC)}$	100	mA
Collector current (Pulse)	$I_{C(pulse)}$ *	200	mA
Total power dissipation	$P_T$	250	mW
Junction temperature	$T_j$	150	$^\circ\text{C}$
Storage temperature	$T_{stg}$	-55 to +150	$^\circ\text{C}$

\*  $PW \leq 10 \text{ ms}$ , duty cycle  $\leq 50 \%$

#### ELECTRICAL CHARACTERISTICS ( $T_a = 25^\circ\text{C}$ )

Parameter	Symbol	Conditions	MIN.	TYP.	MAX.	Unit
Collector cutoff current	$I_{CBO}$	$V_{CB} = 50 \text{ V}$ , $I_E = 0$			100	nA
DC current gain	$h_{FE1}$ **	$V_{CE} = 5.0 \text{ V}$ , $I_C = 5.0 \text{ mA}$	35	60	80	-
DC current gain	$h_{FE2}$ **	$V_{CE} = 5.0 \text{ V}$ , $I_C = 50 \text{ mA}$	80	230		-
Collector saturation voltage	$V_{CE(sat)}$ **	$I_C = 5.0 \text{ mA}$ , $I_B = 0.25 \text{ mA}$		0.05	0.2	V
Low level input voltage	$V_{IL}$ **	$V_{CE} = 5.0 \text{ V}$ , $I_C = 100 \mu\text{A}$		0.9	0.6	V
High level input voltage	$V_{IH}$ **	$V_{CE} = 0.2 \text{ V}$ , $I_C = 5.0 \text{ mA}$	3.0	1.5		V
Input resistance	$R_1$		3.29	4.7	6.11	$\text{k}\Omega$
E-to-B resistance	$R_2$		7	10	13	$\text{k}\Omega$
Turn-on time	$t_{on}$	$V_{CC} = 5 \text{ V}$ , $R_L = 1 \text{ k}\Omega$			0.2	$\mu\text{s}$
Storage time	$t_{stg}$	$V_i = 5 \text{ V}$ , $PW = 2 \mu\text{s}$			5.0	$\mu\text{s}$
Turn-off time	$t_{off}$	duty cycle $\leq 2 \%$			6.0	$\mu\text{s}$

\*\*  $PW \leq 350 \mu\text{s}$ , duty cycle  $\leq 2 \%$

The information in this document is subject to change without notice. Before using this document, please confirm that this is the latest version.  
Not all devices/types available in every country. Please check with local NEC representative for availability and additional information.

TYPICAL CHARACTERISTICS ( $T_a = 25^\circ\text{C}$ )

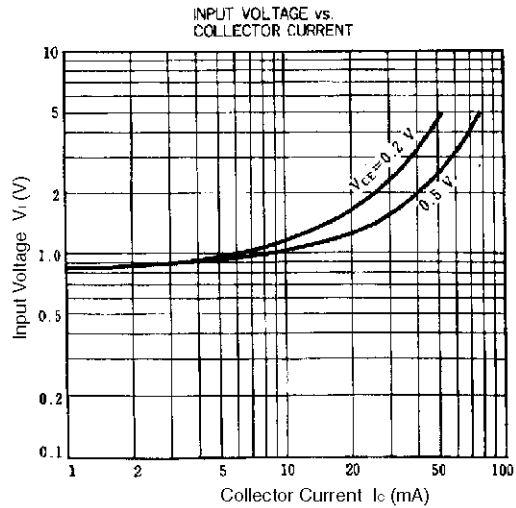
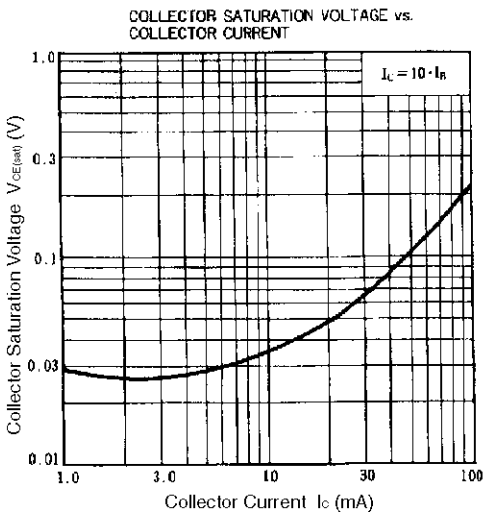
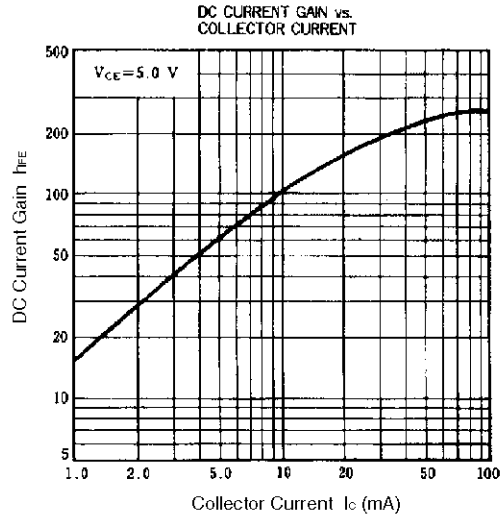
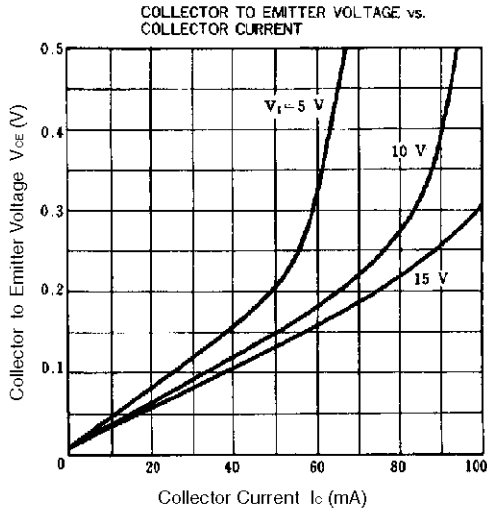
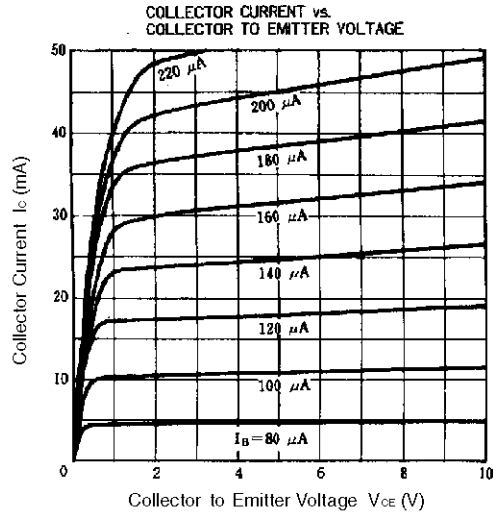
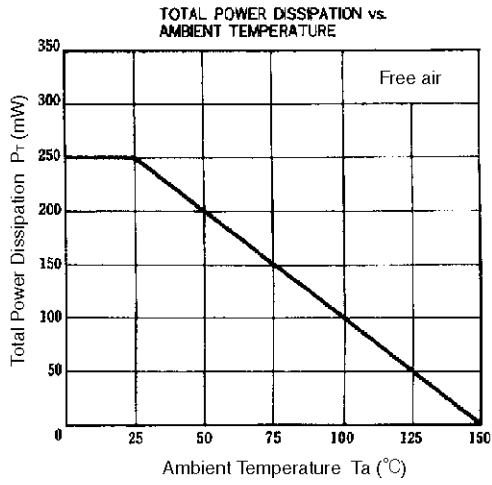

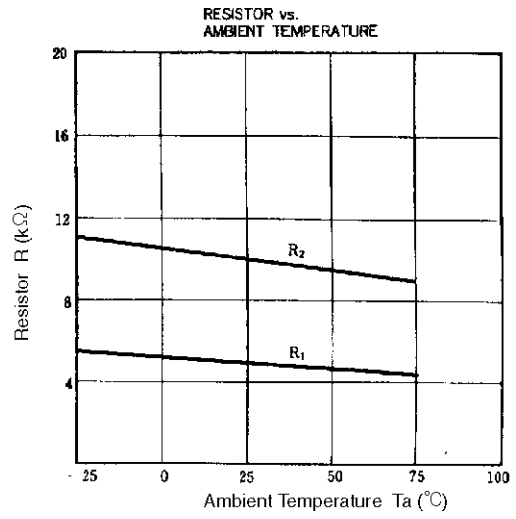
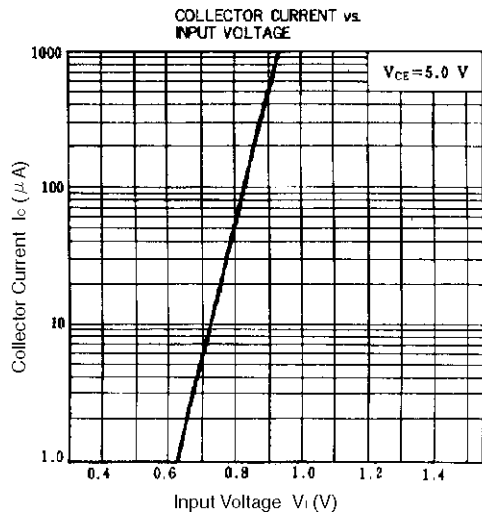

- **The information in this document is current as of July, 2001. The information is subject to change without notice. For actual design-in, refer to the latest publications of NEC's data sheets or data books, etc., for the most up-to-date specifications of NEC semiconductor products. Not all products and/or types are available in every country. Please check with an NEC sales representative for availability and additional information.**
  - No part of this document may be copied or reproduced in any form or by any means without prior written consent of NEC. NEC assumes no responsibility for any errors that may appear in this document.
  - NEC does not assume any liability for infringement of patents, copyrights or other intellectual property rights of third parties by or arising from the use of NEC semiconductor products listed in this document or any other liability arising from the use of such products. No license, express, implied or otherwise, is granted under any patents, copyrights or other intellectual property rights of NEC or others.
  - Descriptions of circuits, software and other related information in this document are provided for illustrative purposes in semiconductor product operation and application examples. The incorporation of these circuits, software and information in the design of customer's equipment shall be done under the full responsibility of customer. NEC assumes no responsibility for any losses incurred by customers or third parties arising from the use of these circuits, software and information.
  - While NEC endeavours to enhance the quality, reliability and safety of NEC semiconductor products, customers agree and acknowledge that the possibility of defects thereof cannot be eliminated entirely. To minimize risks of damage to property or injury (including death) to persons arising from defects in NEC semiconductor products, customers must incorporate sufficient safety measures in their design, such as redundancy, fire-containment, and anti-failure features.
  - NEC semiconductor products are classified into the following three quality grades:  
"Standard", "Special" and "Specific". The "Specific" quality grade applies only to semiconductor products developed based on a customer-designated "quality assurance program" for a specific application. The recommended applications of a semiconductor product depend on its quality grade, as indicated below. Customers must check the quality grade of each semiconductor product before using it in a particular application.
    - "Standard": Computers, office equipment, communications equipment, test and measurement equipment, audio and visual equipment, home electronic appliances, machine tools, personal electronic equipment and industrial robots
    - "Special": Transportation equipment (automobiles, trains, ships, etc.), traffic control systems, anti-disaster systems, anti-crime systems, safety equipment and medical equipment (not specifically designed for life support)
    - "Specific": Aircraft, aerospace equipment, submersible repeaters, nuclear reactor control systems, life support systems and medical equipment for life support, etc.
- The quality grade of NEC semiconductor products is "Standard" unless otherwise expressly specified in NEC's data sheets or data books, etc. If customers wish to use NEC semiconductor products in applications not intended by NEC, they must contact an NEC sales representative in advance to determine NEC's willingness to support a given application.
- (Note)
- (1) "NEC" as used in this statement means NEC Corporation and also includes its majority-owned subsidiaries.
  - (2) "NEC semiconductor products" means any semiconductor product developed or manufactured by or for NEC (as defined above).