

High-output dual power amplifier

BA5417

The BA5417 is a 6 to 15V-compatible dual power amplifier developed for use radio cassette players. It is equipped with standby switching functions for excellent total harmonic distortion and other basic characteristics.

●Applications

Radio cassette / Mini compo players

●Features

- 1) High output.
 $P_{OUT} = 2.8W$ ($V_{CC} = 9V$, $R_L = 3\Omega$, THD = 10%)
 $P_{OUT} = 5.0W$ ($V_{CC} = 12V$, $R_L = 3\Omega$, THD = 10%)
- 2) Excellent audio quality
 THD = 0.1% ($f = 1kHz$, $P_o = 0.5W$)
 $V_{NO} = 0.3mV_{rms}$ ($R_g = 10k\Omega$)
 $RR = 55dB$ ($f_{RR} = 100Hz$)
- 3) Wide supply voltage operating range
 ($V_{CC} = 6.0V$ to $15.0V$).
- 4) Switching noise ("pop" noise) generated when the power is switched on and off is small.
- 5) Ripple mixing when motor starts has been prevented.
- 6) Built-in thermal shutdown circuit.
- 7) Built-in standby switch. Output is not influenced by the standby pin voltage.
- 8) Soft clipping.

●Absolute maximum ratings ($T_a = 25^\circ C$)

Parameter	Symbol	Limits	Unit
Power supply voltage	V_{CC}	20*1	V
Power dissipation	P_d	15*2	W
Operating temperature	T_{opr}	-20 ~ +75	$^\circ C$
Storage temperature	T_{stg}	-55 ~ +150	$^\circ C$

*1 Must be within standby values.

*2 $T_a = 75^\circ C$ (when using infinite heatsink)

●Recommended operating conditions ($T_a = 25^\circ C$)

Parameter	Symbol	Limits	Unit
Power supply voltage	V_{CC}	6.0 ~ 15.0	V

Audio ICs

●Block diagram

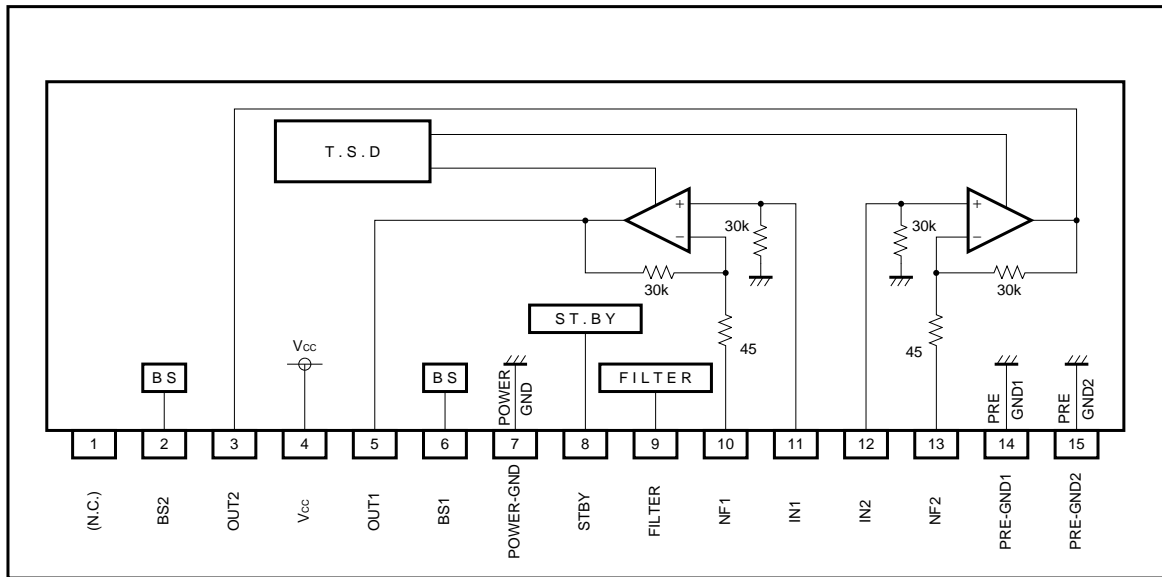

Audio ICs

●Electrical characteristics

(unless otherwise noted, Ta=25°C, Vcc=9.0V, RL=3Ω, RF=120Ω, Rg=600Ω, f=1kHz, OTL mode)

Parameter	Symbol	Min.	Typ.	Max.	Unit	Coniditions
Quiescent current	I _o	–	22	45	mA	V _{IN} =0Vrms
Rated output voltage 1	P _{OUT1}	2.2	2.8	–	W	TDH=10%
Rated output voltage 2	P _{OUT2}	4.0	5.0	–	W	TDH=10%, V _{CC} =12V
Closed-loop voltage gain	G _{VC}	43	45	47	dB	–
Output noise voltage	V _{NO}	–	0.3	1.0	mVrms	R _g =10kΩ, DIN AUDIO
Total harmonic distortion	THD	–	0.1	1.0	%	P _{OUT} =0.5W
Ripple rejection	RR	42	55	–	dB	f _{RR} =100Hz, V _{RR} =-10dBm
Crosstalk	CT	48	65	–	dB	V _O =0dBm
Circuit current (with standby switch off)	I _{OFF}	–	0	20	μA	–
Standby pin current when on	I _{SIN}	–	0.15	0.4	mA	V _{STBY} =V _{CC}
Standby pin control voltage	Activated	V _{STH}	3.5	–	–	–
	Not activated	V _{STL}	–	–	1.2	–

●Measurement circuit

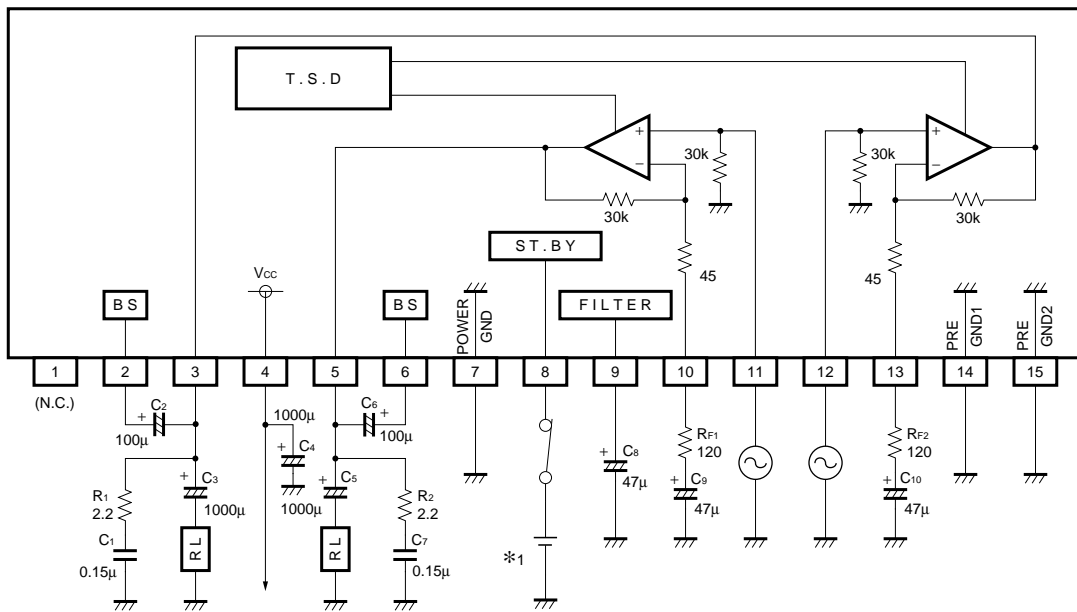

*1 V_{STBY}=3.5V ~ V_{CC}

Fig.1

Audio ICs

●Application example

OTL mode circuit

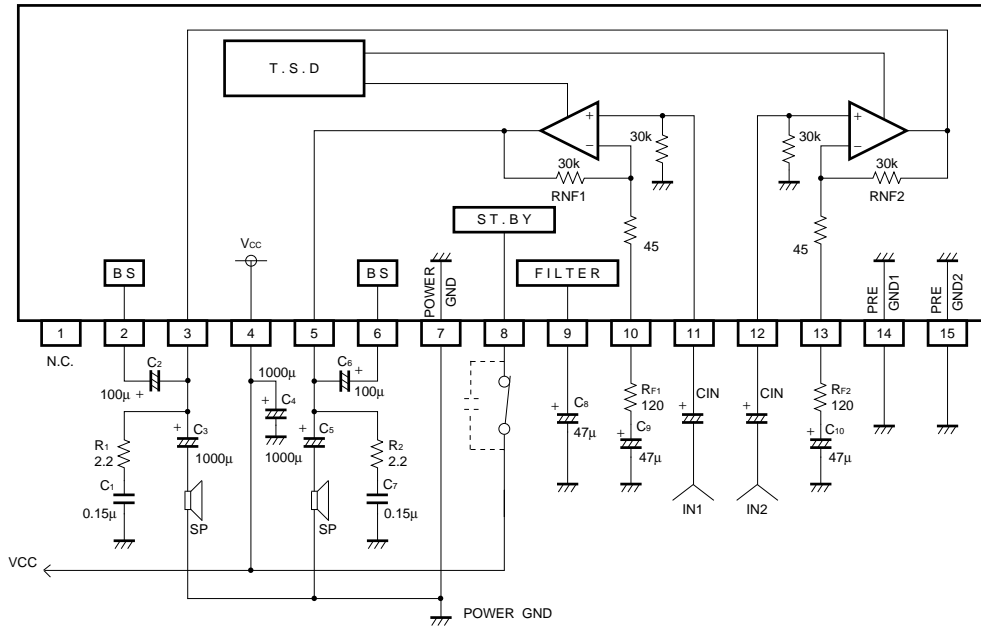
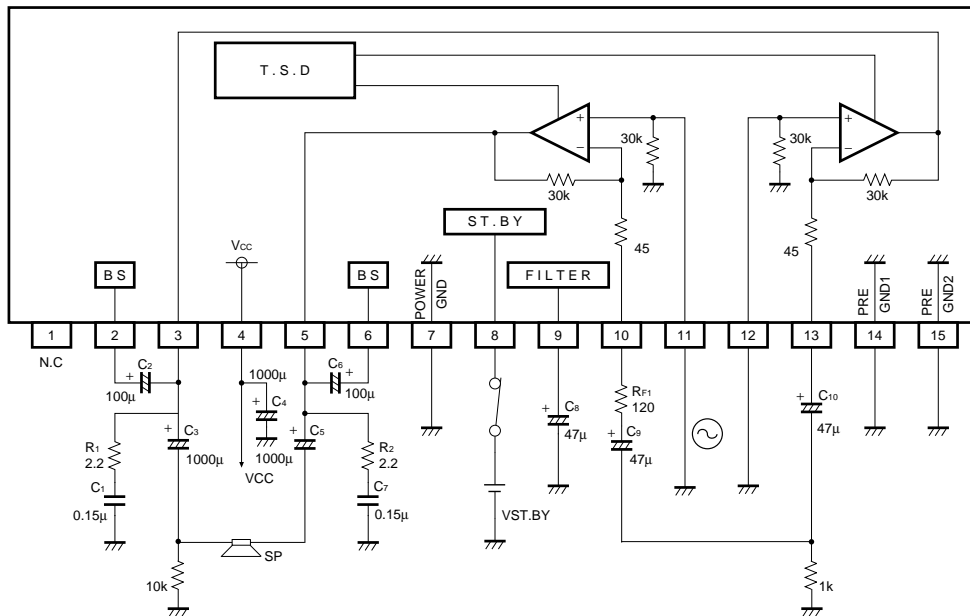

Fig.2

BTL mode circuit



Note : 3pin,5pin need coupling capacitors (C3,C5 100µF) for DC offset voltage.

Fig.3

Audio ICs

●Electrical characteristics

OTL mode

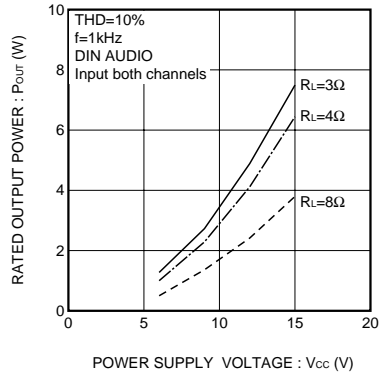

POWER SUPPLY VOLTAGE : V_{CC} (V)
Fig.4 Rated output power vs. Power supply voltage

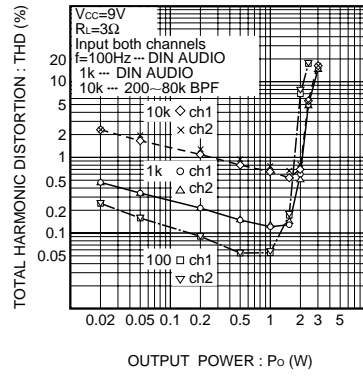

OUTPUT POWER : P_o (W)
Fig.5 Total harmonic distortion vs. Output power

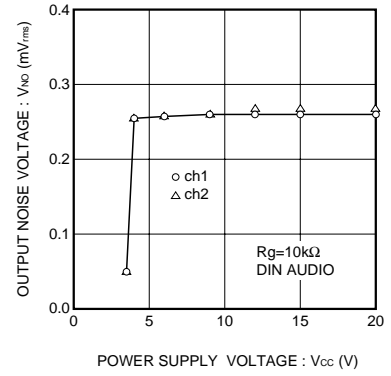

POWER SUPPLY VOLTAGE : V_{CC} (V)
Fig.6 Output noise voltage vs. Power supply voltage

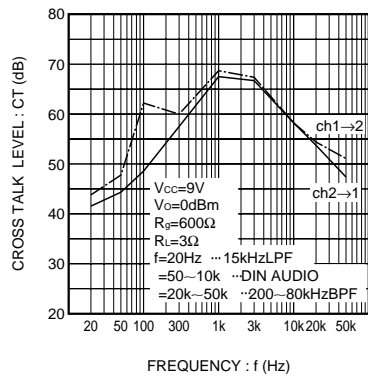

FREQUENCY : f (Hz)
Fig.7 Crosstalk vs. Frequency

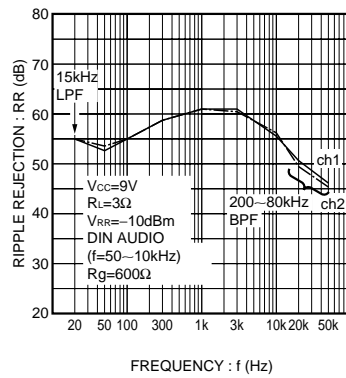

FREQUENCY : f (Hz)
Fig.8 Ripple rejection vs. Frequency

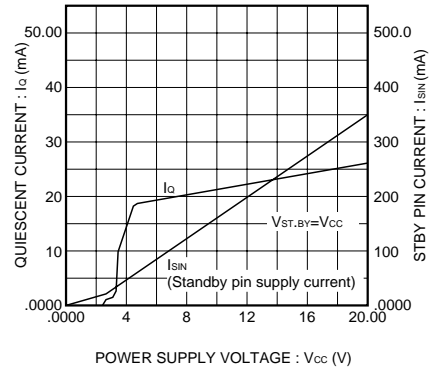

POWER SUPPLY VOLTAGE : V_{CC} (V)
Fig.9 Quiescent standby pin supply current vs. Power supply voltage

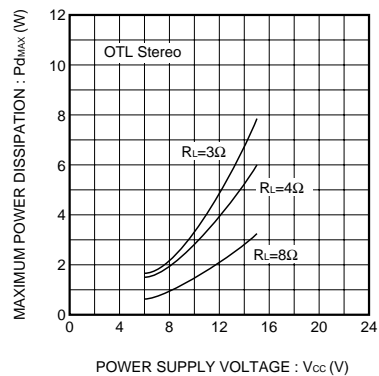

POWER SUPPLY VOLTAGE : V_{CC} (V)
Fig.10 Maximum power dissipation vs. Power supply voltage

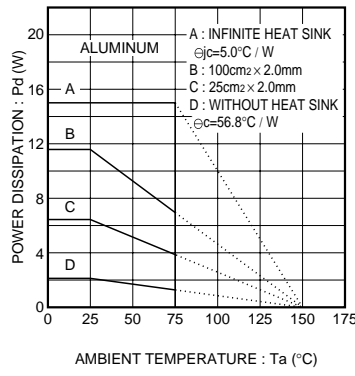

AMBIENT TEMPERATURE : T_a (°C)
Fig.11 Thermal derating curve

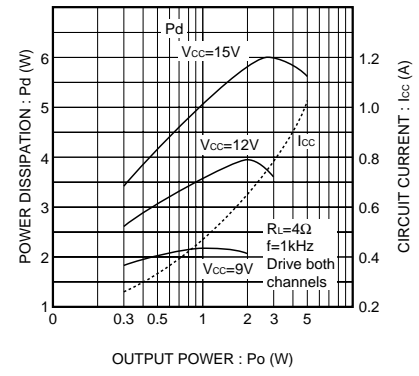

OUTPUT POWER : P_o (W)
Fig.12 Power dissipation vs. Power supply voltage ($R_L=4\Omega$)

Audio ICs

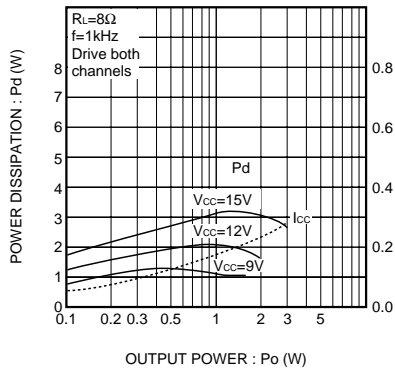

Fig.13 Power dissipation vs. Power supply voltage ($R_L=8\Omega$)

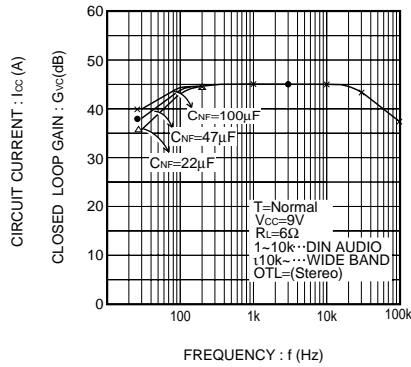

Fig.14 Closed loop gain vs. Frequency

BTL mode

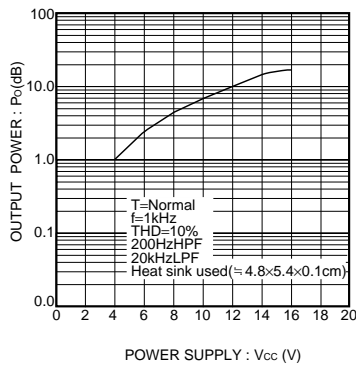

Fig.15 Rated output power vs. Power supply voltage

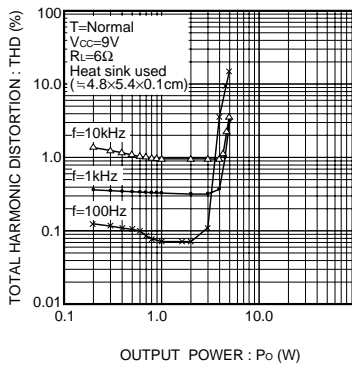

Fig.16 Total harmonic distortion vs. Output power

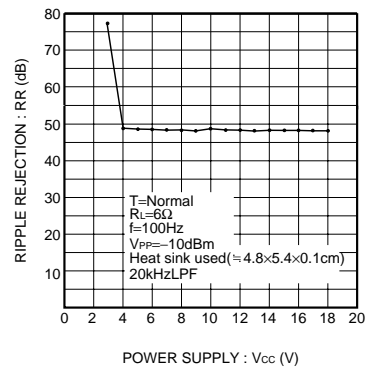

Fig.17 Ripple rejection vs. Power supply voltage

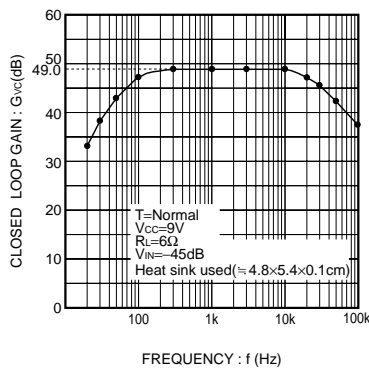

Fig.18 Closed loop gain vs. Frequency

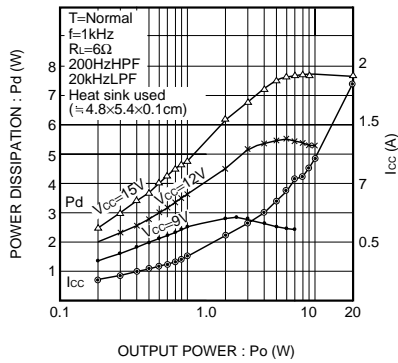

Fig.19 Power dissipation vs. Power supply voltage ($R_L=6\Omega$)

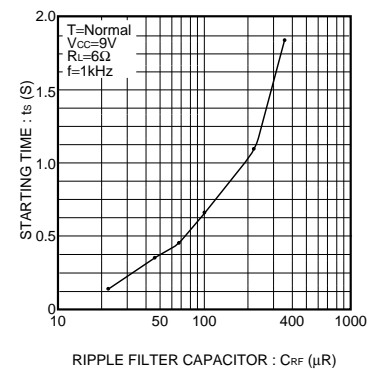

Fig.20 Starting time vs. Ripple filter capacitor

