

## SMALL SIGNAL NPN TRANSISTOR WITH CONTROLLED BASE-EMITTER VOLTAGE

NEW PRODUCT

### Features

- Low Deviation in Base-Emitter Voltage
- Surface Mount Package
- Ideally Suited for Automated Assembly Processes
- **Lead Free by Design/RoHS Compliant (Note 2)**
- **"Green" Device (Note 2)**

### Mechanical Data

- Case: SOT-23
- Case material: Molded Plastic. "Green Molding" Compound. UL Flammability Classification Rating 94V-0
- Moisture Sensitivity: Level 1 per J-STD-020C
- Terminals Connections: See Diagram
- Terminals: Finish - Matte Tin annealed over Alloy 42 leadframe. Solderable per MIL-STD-202, Method 208
- Marking Type Code Information: See Page 4
- Ordering Information: See Page 4
- Weight: 0.008 grams (approximate)

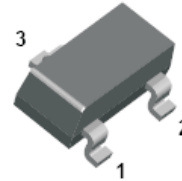


Fig. 1 SOT-23

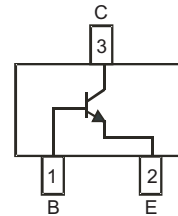


Fig. 2 : Schematic and Pin Configuration

### Maximum Ratings @ $T_A = 25^\circ\text{C}$ unless otherwise specified

Characteristic	Symbol	Value	Unit
Collector-Base Voltage	$V_{CBO}$	50	V
Collector-Emitter Voltage	$V_{CEO}$	45	V
Emitter-Base Voltage	$V_{EBO}$	6	V
Output Current - Continuous (Note 3)	$I_C$	200	mA
Peak Collector Current	$I_{CM}$	200	mA
Peak Emitter Current	$I_{EM}$	200	mA
Power Dissipation (Note 3)	$P_d$	300	mW
Power Deration	$P_{der}$	2.4	mW/ $^\circ\text{C}$

### Thermal Characteristics

Characteristic	Symbol	Value	Unit
Operating and Storage Junction Temperature Range	$T_J, T_{STG}$	-55 to +150	$^\circ\text{C}$
Thermal Resistance, Junction to Ambient Air (Note 3)	$R_{\theta JA}$	417	$^\circ\text{C}/\text{W}$

- Notes:
1. No purposefully added Lead
  2. Diodes Inc.'s "Green" policy can be found on our website at [http://www.diodes.com/products/lead\\_free/index.php](http://www.diodes.com/products/lead_free/index.php).
  3. Device mounted on FR-4 PCB, 1 inch x 0.85 inch x 0.062 inch; pad layout as shown on page 4 or on Diodes Inc. suggested pad layout document AP02001, which can be found on our website at <http://www.diodes.com/datasheets/ap02001.pdf>.

**Electrical Characteristics:**
**NPN Transistor**

 @  $T_A = 25^\circ\text{C}$  unless otherwise specified

Characteristic	Symbol	Min	Typ	Max	Unit	Test Condition
<b>OFF CHARACTERISTICS (Note 4)</b>						
Collector-Base Breakdown Voltage	$V_{(BR)CBO}$	50	—	—	V	$I_C = 10\mu\text{A}, I_E = 0$
Collector-Emitter Breakdown Voltage	$V_{(BR)CEO}$	45	—	—	V	$I_C = 1.0\text{mA}, I_B = 0$
Emitter-Base Breakdown Voltage	$V_{(BR)EBO}$	6	—	—	V	$I_E = 10\mu\text{A}, I_C = 0$
Collector Cutoff Current	$I_{CEX}$	—	—	15	nA	$V_{CE} = 50\text{V}, V_{EB(OFF)} = 3.0\text{V}$
Base Cutoff Current ( $I_{BEX}$ )	$I_{BL}$	—	—	15	nA	$V_{CE} = 40\text{V}, V_{EB(OFF)} = 3.0\text{V}$
Collector-Base Cut Off Current	$I_{CBO}$	—	—	15	nA	$V_{CB} = 40\text{V}, I_E = 0$
				5	$\mu\text{A}$	$V_{CB} = 30\text{V}, T_A = 150^\circ\text{C}$
Collector-Emitter Cut Off Current, $I_{O(OFF)}$	$I_{CEO}$	—	—	50	nA	$V_{CE} = 40\text{V}, I_B = 0$
Emitter-Base Cut Off Current	$I_{EBO}$	—	—	50	nA	$V_{EB} = 5\text{V}, I_C = 0$
<b>ON CHARACTERISTICS (Note 4)</b>						
DC Current Gain	$h_{fe}$	180	—	—	—	$V_{CE} = 5\text{V}, I_C = 100\mu\text{A}$
		150	—	—	—	$V_{CE} = 5\text{V}, I_C = 500\mu\text{A}$
		220	—	—	—	$V_{CE} = 5\text{V}, I_C = 1\text{mA}$
		220	—	—	—	$V_{CE} = 5\text{V}, I_C = 2\text{mA}$
		150	—	—	—	$V_{CE} = 5\text{V}, I_C = 5\text{mA}$
		150	—	—	—	$V_{CE} = 5\text{V}, I_C = 10\text{mA}$
Collector-Emitter Saturation Voltage	$V_{CE(SAT)}$	—	0.09	0.18	V	$I_C = 10\text{mA}, I_B = 0.5\text{mA}$
		—	0.2	0.4	V	$I_C = 100\text{mA}, I_B = 5\text{mA}$
Base-Emitter Turn-On Voltage	$V_{BE(ON)}$	647	657	667	mV	$V_{CE} = 5\text{V}, I_C = 2\text{mA}$
Base-Emitter Saturation Voltage	$V_{BE(SAT)}$	—	—	0.8	V	$I_C = 10\text{mA}, I_B = 0.5\text{mA}$
		—	—	0.9	V	$I_C = 100\text{mA}, I_B = 5\text{mA}$
<b>SMALL SIGNAL CHARACTERISTICS</b>						
Output Capacitance	$C_{OBO}$	—	3	—	pF	$V_{CB} = 5.0\text{V}, f = 1.0\text{MHz}, I_E = 0$
Input Impedance	$h_{ie}$	—	4.5	—	$\text{K}\Omega$	$V_{CE} = 5.0\text{V}, I_C = 2\text{mA}, f = 1.0\text{KHz}$
Voltage Feedback Ratio	$h_{re}$	—	2	—	$\times 10\text{E-4}$	
Small Signal Current Gain	$h_{fe}$	—	200	—	—	
Output Admittance	$h_{oe}$	—	30	—	$\mu\text{S}$	
Current Gain-Bandwidth Product	$f_T$	100	—	—	MHz	$V_{CE} = 20\text{V}, I_C = 10\text{mA}, f = 100\text{MHz}$
Noise Figure	NF	—	—	10	dB	$V_{CE} = 5\text{V}, I_C = 100\mu\text{A}, R_S = 1\text{K}\Omega, f = 1\text{kHz}$

Notes: 4. Short duration pulse test used to minimize self-heating effect.

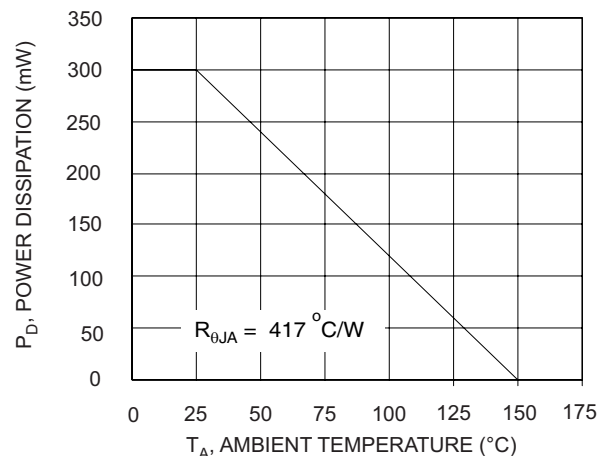
**Typical Characteristics**


Fig. 3 Max Power Dissipation vs Ambient Temperature

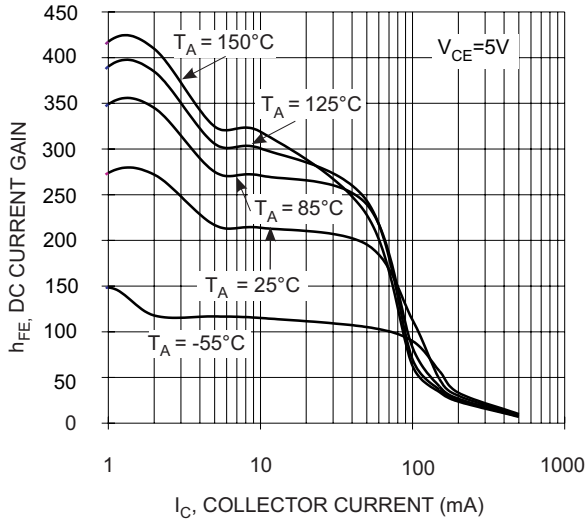


Fig. 4  $h_{FE}$  vs  $I_C$

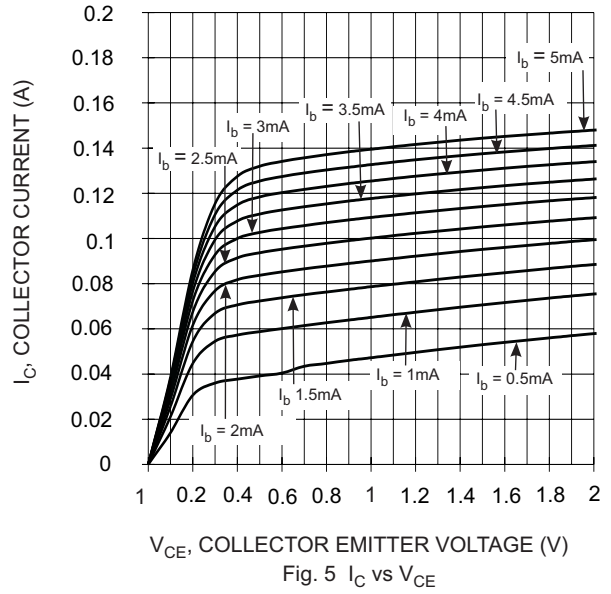


Fig. 5  $I_C$  vs  $V_{CE}$

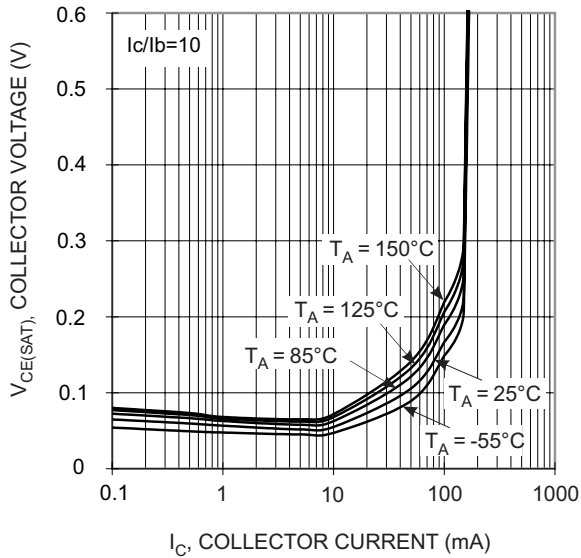


Fig. 6  $V_{CE(SAT)}$  vs  $I_C$

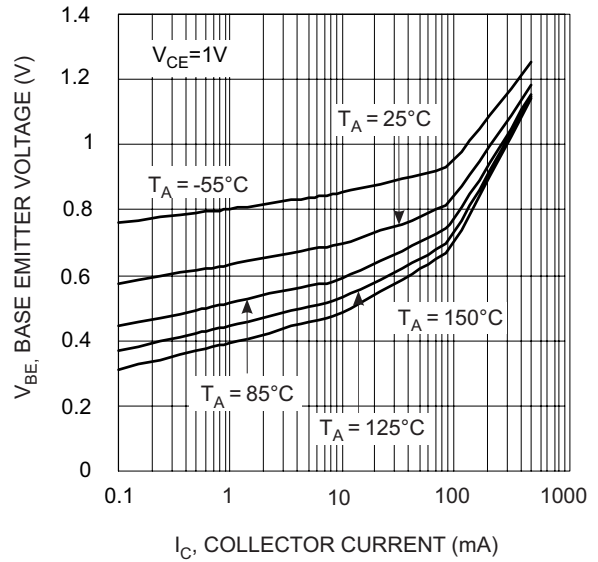


Fig. 7  $V_{BE}$  vs  $I_C$

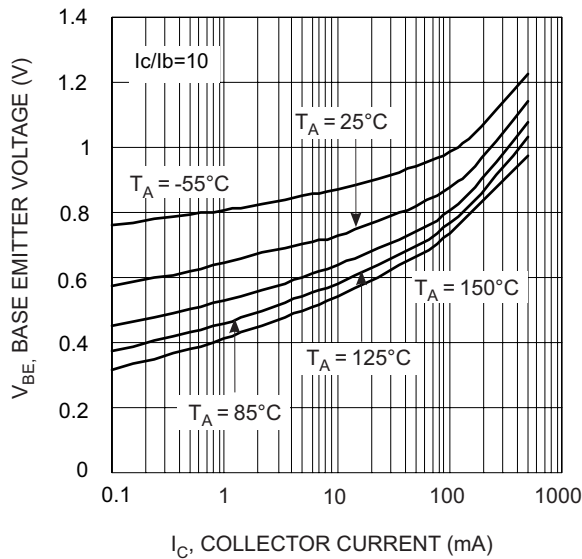


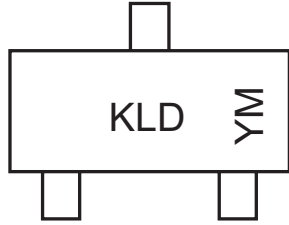
Fig. 8  $V_{BE(SAT)}$  vs  $I_C$

**Ordering Information** (Note 4)

Device	Packaging	Shipping
BC847BLD-7	SOT-23	3000/Tape & Reel

Notes: 4. For Packaging Details, please see below or go to our website at <http://www.diodes.com/datasheets/ap02007.pdf>.

**Marking Information**



KLD = Product Type Marking Code  
 YM = Date Code Marking  
 Y = Year ex: T = 2006  
 M = Month ex: 9 = September

Fig. 9

Date Code Key

Year	2006	2007	2008	2009	2010	2011	2012
Code	T	U	V	W	X	Y	Z

Month	Jan	Feb	March	Apr	May	Jun	Jul	Aug	Sep	Oct	Nov	Dec
Code	1	2	3	4	5	6	7	8	9	O	N	D

**Mechanical Details**

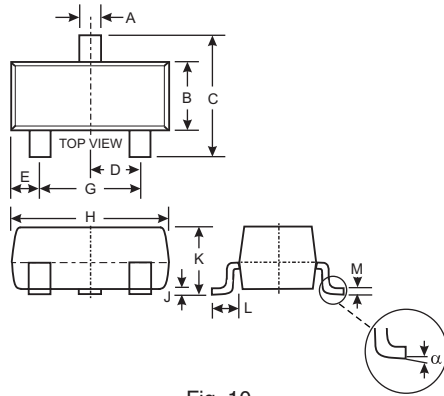


Fig. 10

SOT-23		
Dim	Min	Max
A	0.37	0.51
B	1.20	1.40
C	2.30	2.50
D	0.89	1.03
E	0.45	0.60
G	1.78	2.05
H	2.80	3.00
J	0.013	0.10
K	0.903	1.10
L	0.45	0.61
M	0.085	0.180
α	0°	8°
All Dimensions in mm		

**Suggested Pad Layout: (Based on IPC-SM-782)**

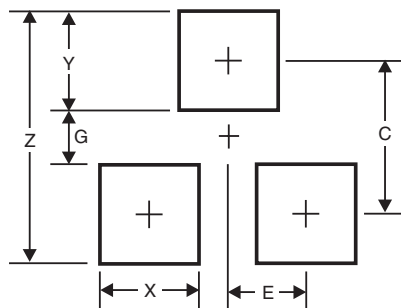


Fig. 11

Figure 11 Dimensions	SOT-23
Z	3.4
G	0.7
X	0.9
Y	1.4
C	2.0
E	0.9
All Dimensions in mm	

**IMPORTANT NOTICE**

Diodes Incorporated and its subsidiaries reserve the right to make modifications, enhancements, improvements, corrections or other changes without further notice to any product herein. Diodes Incorporated does not assume any liability arising out of the application or use of any product described herein; neither does it convey any license under its patent rights, nor the rights of others. The user of products in such applications shall assume all risks of such use and will agree to hold Diodes Incorporated and all the companies whose products are represented on our website, harmless against all damages.

**LIFE SUPPORT**

Diodes Incorporated products are not authorized for use as critical components in life support devices or systems without the expressed written approval of the President of Diodes Incorporated.