

DATA SHEET

BLV103 UHF power transistor

Product specification

March 1993

UHF power transistor

BLV103

FEATURES

- Internal matching for an optimum wideband capability and high gain
- Emitter-ballasting resistors for optimum temperature profile
- Gold metallization ensures excellent reliability.

DESCRIPTION

NPN silicon planar epitaxial transistor encapsulated in a 6-lead SOT171 flange envelope with a ceramic cap. It is intended for common emitter, class-AB operation in cellular radio base stations in the 960 MHz frequency band. All leads are isolated from the mounting base.

PINNING - SOT171

PIN	DESCRIPTION
1	emitter
2	emitter
3	base
4	collector
5	emitter
6	emitter

QUICK REFERENCE DATA

RF performance at $T_h = 25\text{ }^\circ\text{C}$ in a common emitter test circuit.

MODE OF OPERATION	f (MHz)	V _{CE} (V)	P _L (W)	G _p (dB)	η_c (%)
c.w. class-AB	960	24	4	> 11.5	> 45

WARNING

Product and environmental safety - toxic materials

This product contains beryllium oxide. The product is entirely safe provided that the BeO disc is not damaged. All persons who handle, use or dispose of this product should be aware of its nature and of the necessary safety precautions. After use, dispose of as chemical or special waste according to the regulations applying at the location of the user. It must never be thrown out with the general or domestic waste.

PIN CONFIGURATION

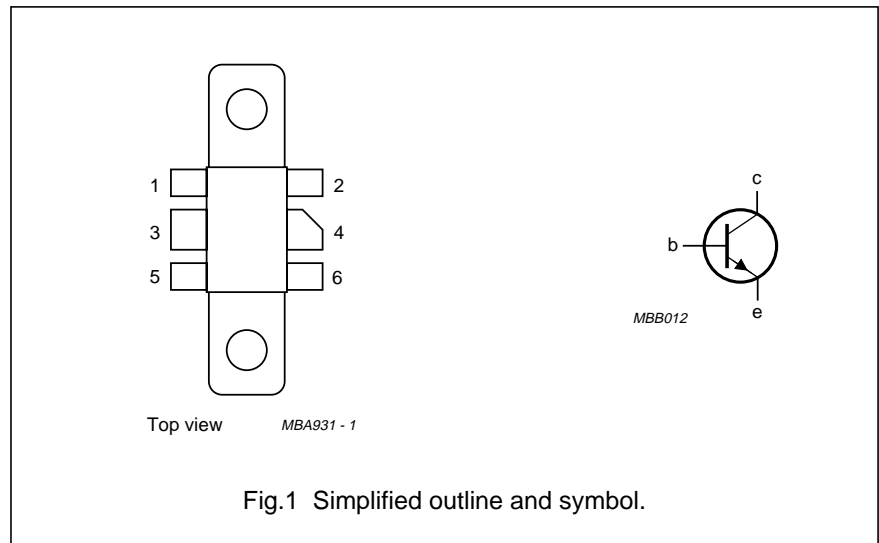

UHF power transistor

BLV103

LIMITING VALUES

In accordance with the Absolute Maximum System (IEC 134).

SYMBOL	PARAMETER	CONDITIONS	MIN.	MAX.	UNIT
V_{CBO}	collector-base voltage	open emitter	–	50	V
V_{CEO}	collector-emitter voltage	open base	–	30	V
V_{EBO}	emitter-base voltage	open collector	–	4	V
I_C	collector current	DC or average value	–	1.25	A
P_{tot}	total power dissipation	$T_{mb} = 25\text{ °C}$	–	17	W
T_{stg}	storage temperature range		–65	150	°C
T_j	junction operating temperature		–	200	°C

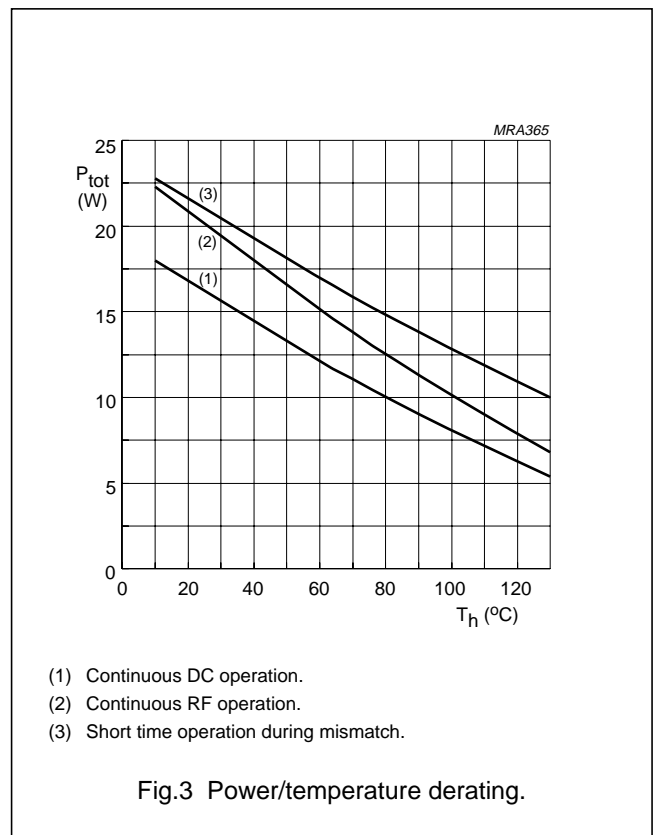
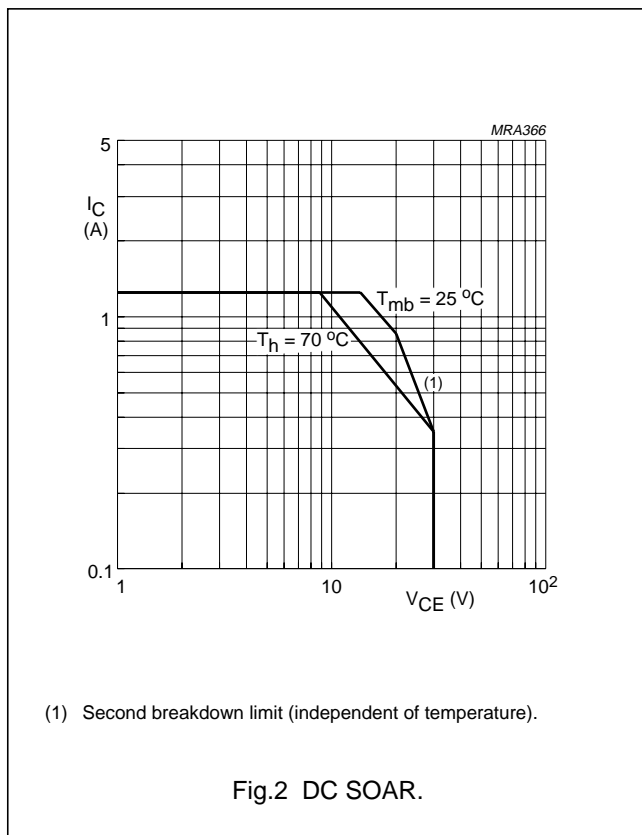

THERMAL RESISTANCE

SYMBOL	PARAMETER	CONDITIONS	MAX.	UNIT
$R_{th\ j-mb}$	from junction to mounting base	$T_{mb} = 25\text{ °C}$; $P_{dis} = 17\text{ W}$	10.3	K/W
$R_{th\ mb-h}$	from mounting base to heatsink		0.4	K/W

UHF power transistor

BLV103

CHARACTERISTICS

T_j = 25 °C.

SYMBOL	PARAMETER	CONDITIONS	MIN.	TYP.	MAX.	UNIT
V _{(BR)CBO}	collector-base breakdown voltage	open emitter; I _C = 4 mA	50	–	–	V
V _{(BR)CEO}	collector-emitter breakdown voltage	open base; I _C = 30 mA	30	–	–	V
V _{(BR)EBO}	emitter-base breakdown voltage	open collector; I _E = 2 mA	4	–	–	V
I _{CES}	collector-emitter leakage current	V _{BE} = 0; V _{CE} = 30 V	–	–	1	mA
h _{FE}	DC current gain	V _{CE} = 25 V; I _C = 300 mA	20	40	–	
C _c	collector capacitance	V _{CB} = 25 V; I _E = I _e = 0; f = 1 MHz	–	6.6	8	pF
C _{re}	feedback capacitance	V _{CE} = 25 V; I _C = 20 mA; f = 1 MHz	–	3.5	4.5	pF

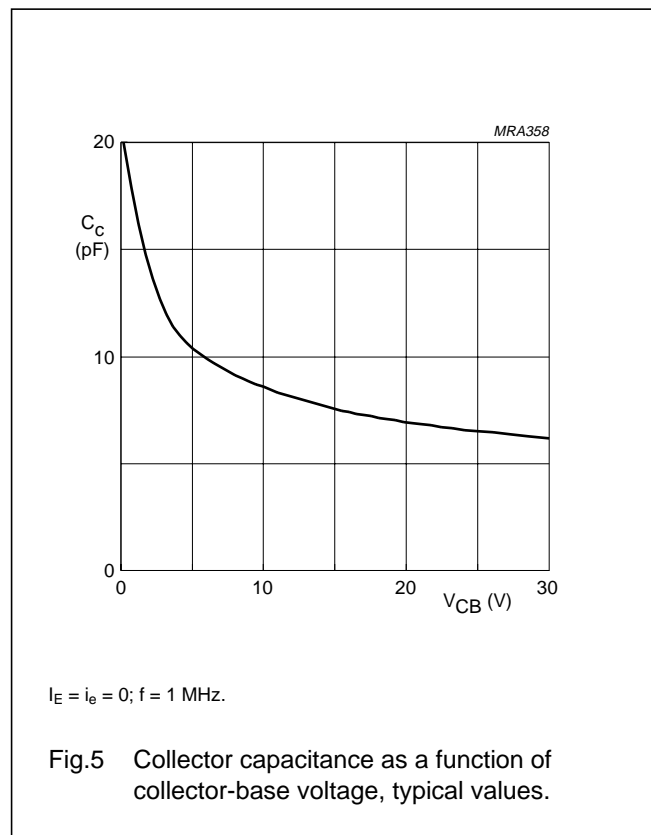
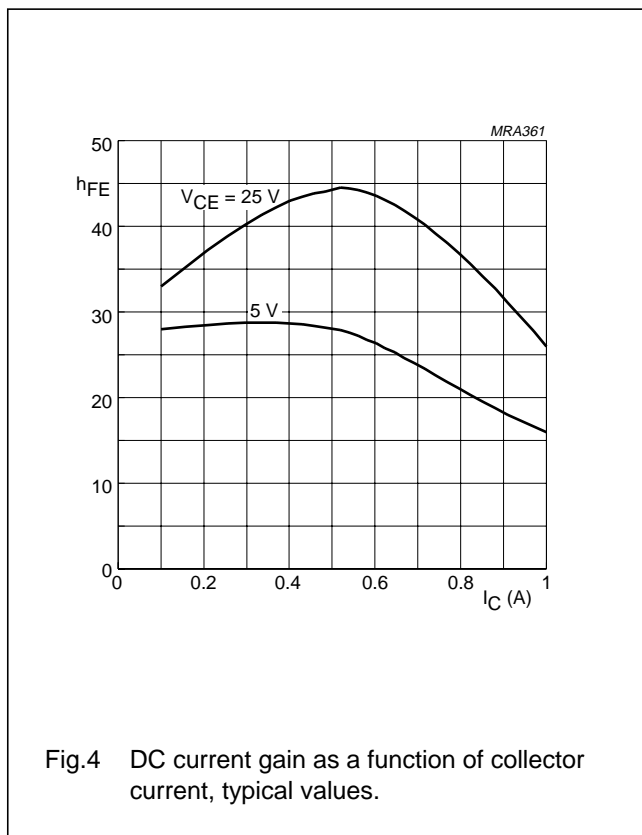

UHF power transistor

BLV103

APPLICATION INFORMATION

RF performance at $T_h = 25\text{ }^\circ\text{C}$ in a common emitter test circuit, $R_{th\text{ mb-h}} = 0.4\text{ K/W}$.

MODE OF OPERATION	f (MHz)	V _{CE} (V)	I _{CQ} (mA)	P _L (W)	G _P (dB)	η _c (%)
c.w. class-AB	960	24	5	4	> 11.5 typ. 13	> 45 typ. 48
	960	26	5	4	typ. 14	typ. 50

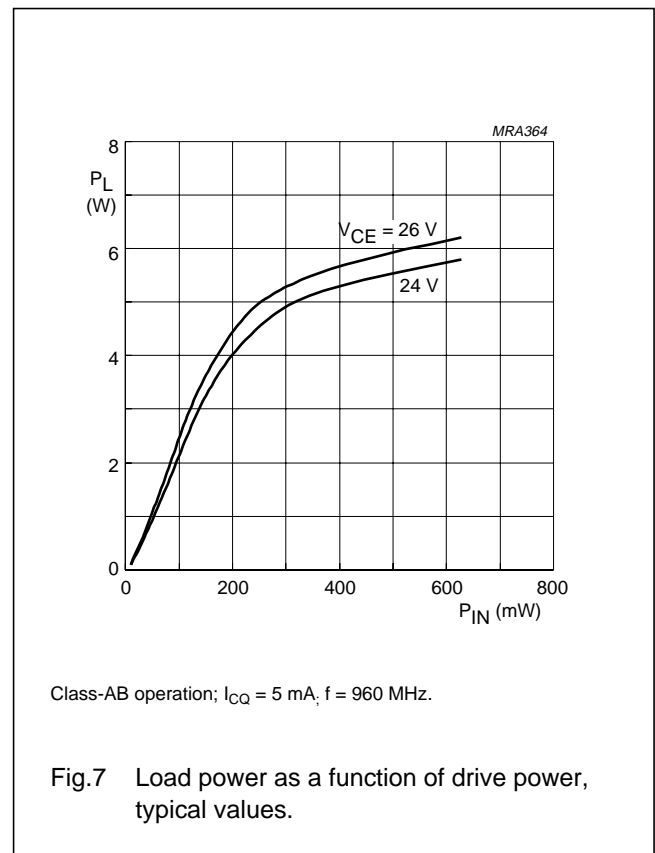
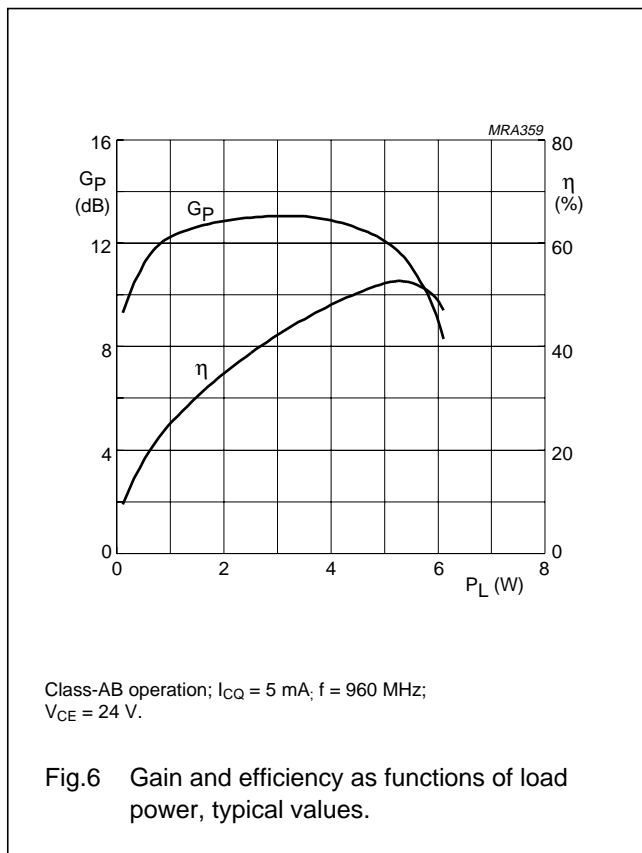

Ruggedness in class-AB operation

The BLV103 is capable of withstanding a full load mismatch corresponding to VSWR = 50:1 through all phases at rated output power under the following conditions:

V_{CE} = 24 V; f = 960 MHz; T_h = 25 °C;
R_{th mb-h} = 0.4 K/W.

UHF power transistor

BLV103

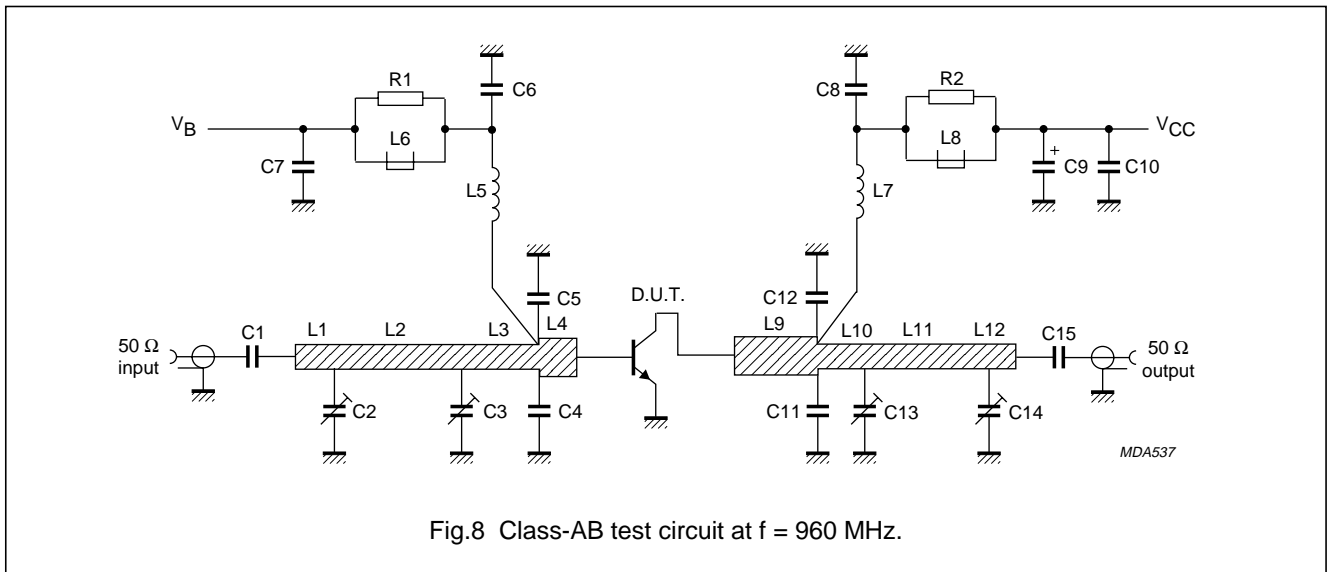

List of components (see test circuit)

COMPONENT	DESCRIPTION	VALUE	DIMENSIONS	CATALOGUE NO.
C1, C6, C7, C8, C15	multilayer ceramic chip capacitor	330 pF		
C2, C3, C13, C14	film dielectric trimmer	1.4 to 5.5 pF		2222 809 09001
C4, C5	multilayer ceramic chip capacitor (note 1)	5.1 pF		
C9	35 V solid aluminum capacitor	2.2 μ F		2222 128 50228
C10	multilayer ceramic chip capacitor	3 \times 100 nF in parallel		
C11, C12	multiplayer ceramic chip capacitor (note 2)	6.2 pF		
L1, L12	stripline (note 3)	50 Ω	9 mm \times 2.4 mm	
L2, L11	stripline (note 3)	50 Ω	23 mm \times 2.4 mm	
L3	stripline (note 3)	50 Ω	16 mm \times 2.4 mm	
L4	stripline (note 3)	43 Ω	3 mm \times 3 mm	
L5	3 turns enamelled 0.8 mm copper wire		int. dia. 3 mm; length 5 mm; leads 2 mm \times 5 mm	
L6, L8	grade 3B Ferroxcube wideband HF choke			4312 020 36642
L7	4 turns enamelled 0.8 mm copper wire		int. dia. 4 mm; length 5 mm; leads 2 mm \times 5 mm	
L9	stripline (note 3)	43 Ω	14.5 mm \times 3 mm	
L10	stripline (note 3)	50 Ω	4.5 mm \times 2.4 mm	
R1, R2	0.4 W metal film resistor	10 Ω		2322 151 71009

UHF power transistor

BLV103

Notes

1. American Technical Ceramics (ATC) capacitor, type 100A or other capacitor of the same quality.
2. American Technical Ceramics (ATC) capacitor, type 100B or other capacitor of the same quality.
3. The striplines are on a double copper-clad printed circuit board, with PTFE fibre-glass dielectric ($\epsilon_r = 2.2$); thickness $\frac{1}{32}$ inch.

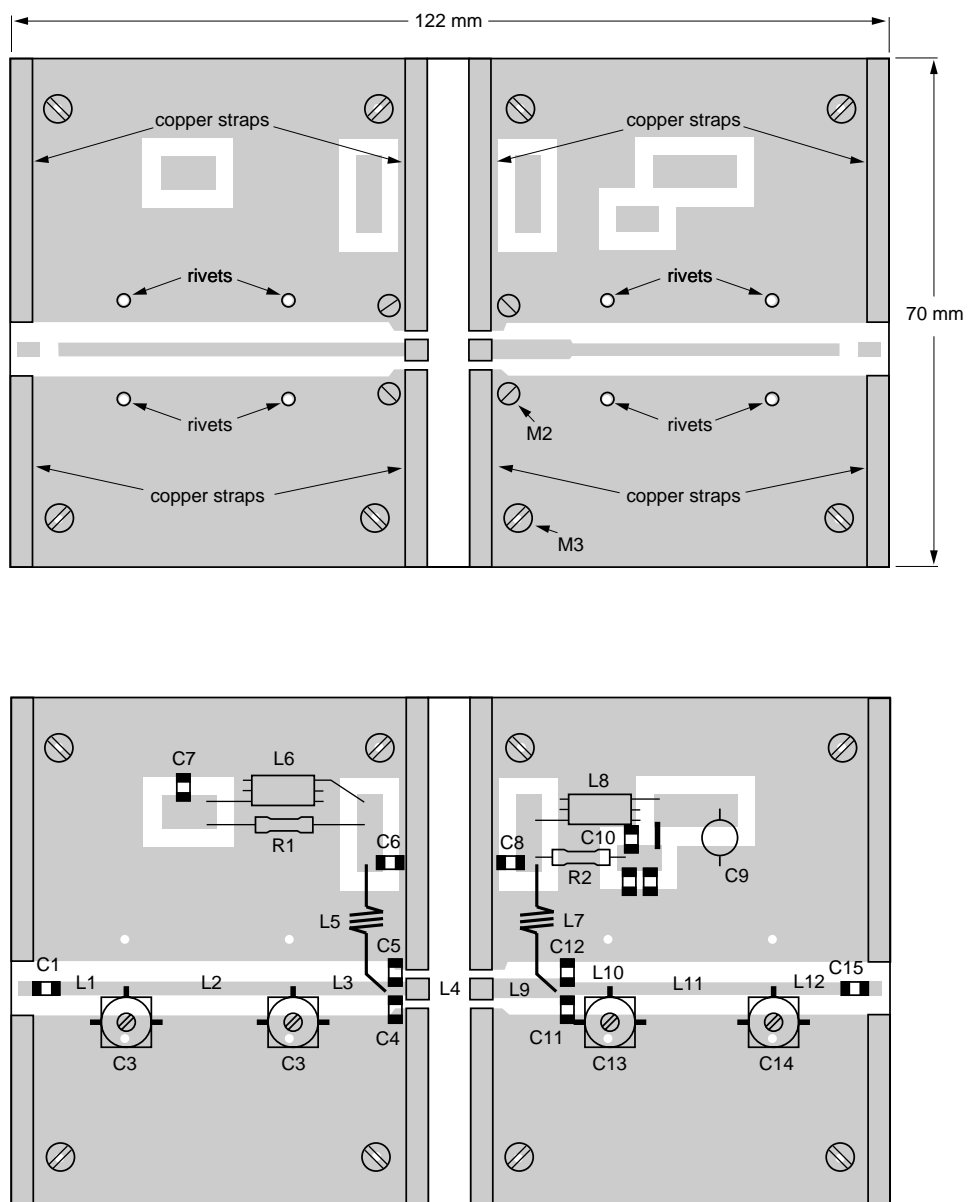

MDA536

The circuit and components are situated on one side of a copper-clad PTFE fibre-glass board; the other side is fully metallized and serves as a ground plane. Connections are made by means of fixing screws, hollow rivets and copper straps around the board and under the emitters, to provide a direct contact between the components side and the ground plane.

Fig.9 Component layout for 960 MHz class-AB test circuit.

UHF power transistor

BLV103

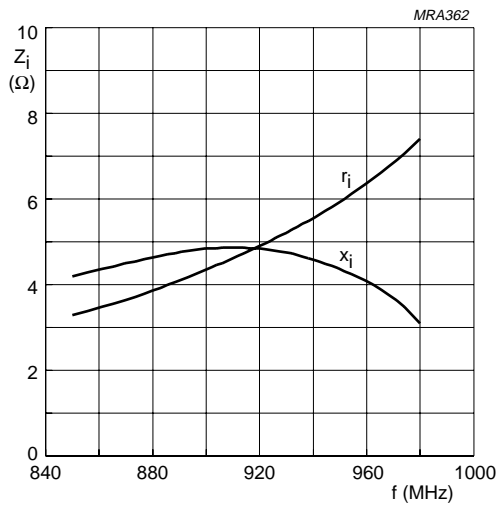

Class-AB operation; $V_{CE} = 24$ V; $I_{CQ} = 5$ mA;
 $P_L = 4$ W; $T_h = 25$ °C.

Fig.10 Input impedance (series components) as a function of frequency, typical values.

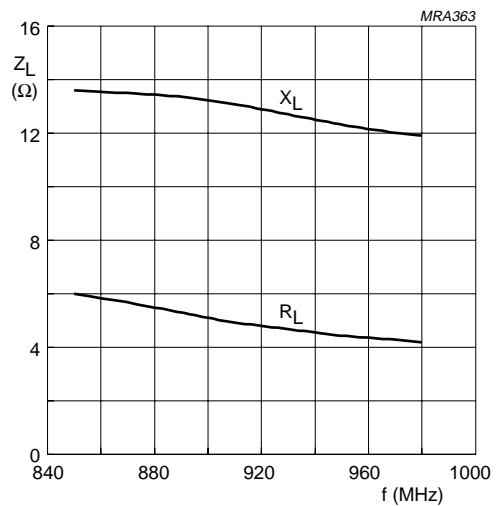

Class-AB operation; $V_{CE} = 24$ V; $I_{CQ} = 5$ mA;
 $P_L = 4$ W; $T_h = 25$ °C.

Fig.11 Load impedance (series components) as a function of frequency, typical values.

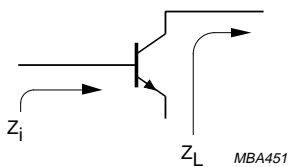
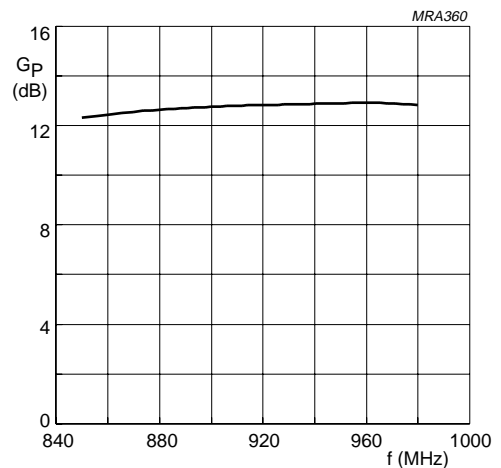

Fig.12 Definition of transistor impedance.



Class-AB operation; $V_{CE} = 24$ V; $I_{CQ} = 5$ mA;
 $P_L = 4$ W; $T_h = 25$ °C.

Fig.13 Power gain as a function of frequency, typical values.

UHF power transistor

BLV103

PACKAGE OUTLINE

Flanged ceramic package; 2 mounting holes; 6 leads

SOT171A

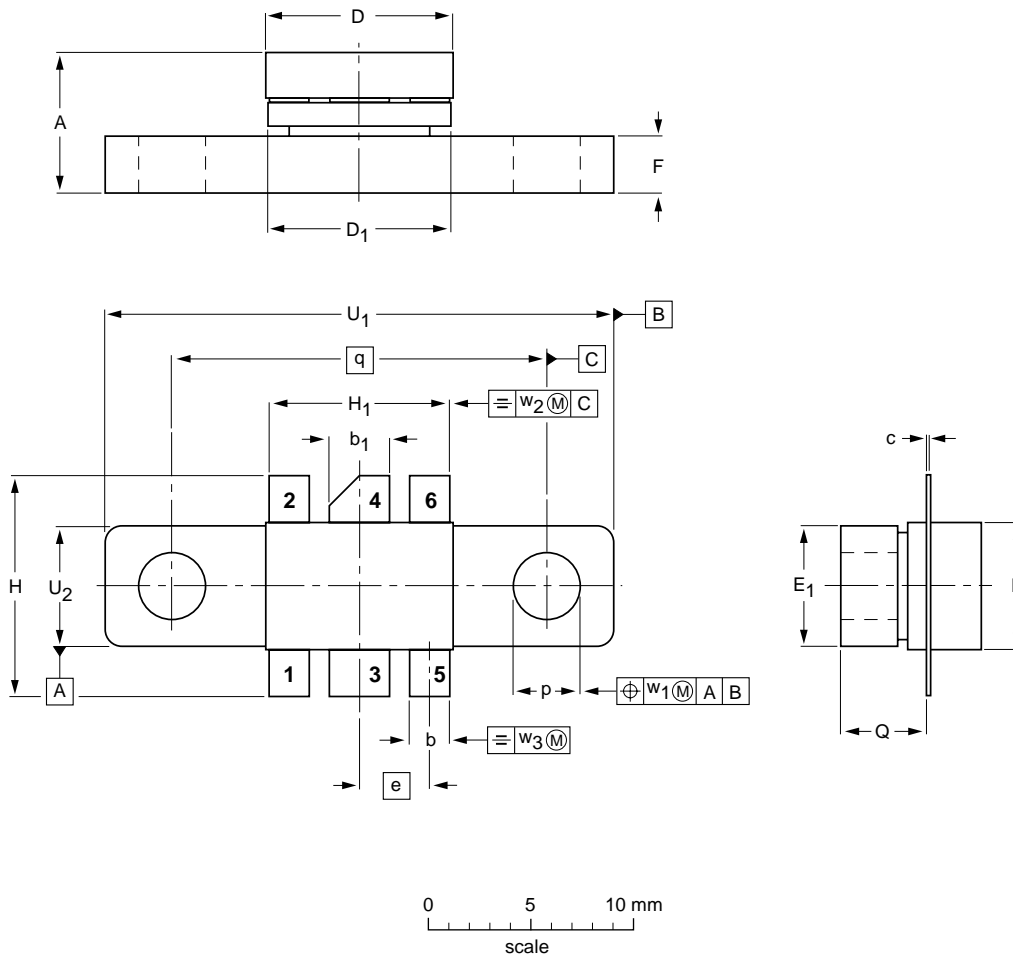

DIMENSIONS (millimetre dimensions are derived from the original inch dimensions)

UNIT	A	b	b ₁	c	D	D ₁	E	E ₁	e	F	H	H ₁	p	Q	q	U ₁	U ₂	w ₁	w ₂	w ₃
mm	6.81 6.07	2.15 1.85	3.20 2.89	0.16 0.07	9.25 9.04	9.30 8.99	5.95 5.74	6.00 5.70	3.58	3.05 2.54	11.31 10.54	9.27 9.01	3.43 3.17	4.32 4.11	18.42	24.90 24.63	6.00 5.70	0.51	1.02	0.26
inches	0.268 0.239	0.085 0.073	0.126 0.114	0.006 0.003	0.364 0.356	0.366 0.354	0.234 0.226	0.236 0.224	0.140	0.120 0.100	0.445 0.415	0.365 0.355	0.135 0.125	0.170 0.162	0.725	0.980 0.970	0.236 0.224	0.02	0.04	0.01

OUTLINE VERSION	REFERENCES				EUROPEAN PROJECTION	ISSUE DATE
	IEC	JEDEC	EIAJ			
SOT171A						97-06-28

UHF power transistor

BLV103

DEFINITIONS

Data Sheet Status	
Objective specification	This data sheet contains target or goal specifications for product development.
Preliminary specification	This data sheet contains preliminary data; supplementary data may be published later.
Product specification	This data sheet contains final product specifications.
Limiting values	
Limiting values given are in accordance with the Absolute Maximum Rating System (IEC 134). Stress above one or more of the limiting values may cause permanent damage to the device. These are stress ratings only and operation of the device at these or at any other conditions above those given in the Characteristics sections of the specification is not implied. Exposure to limiting values for extended periods may affect device reliability.	
Application information	
Where application information is given, it is advisory and does not form part of the specification.	

LIFE SUPPORT APPLICATIONS

These products are not designed for use in life support appliances, devices, or systems where malfunction of these products can reasonably be expected to result in personal injury. Philips customers using or selling these products for use in such applications do so at their own risk and agree to fully indemnify Philips for any damages resulting from such improper use or sale.