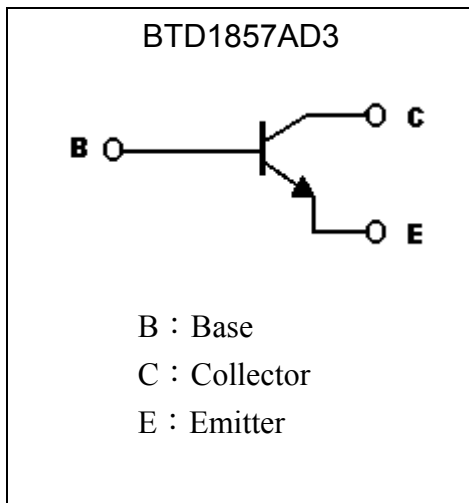
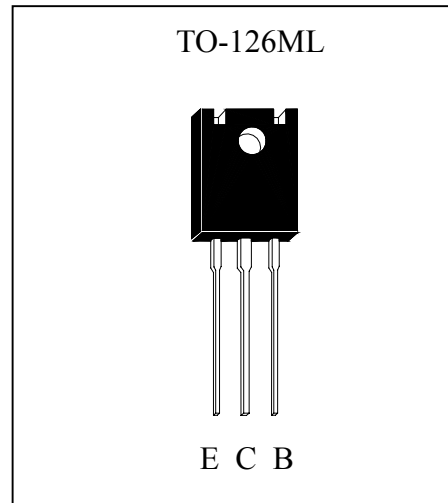

Silicon NPN Epitaxial Planar Transistor

BTD1857AD3

Description

- High BV_{CEO}
- High current capability
- Complementary to BTB1236AD3
- Pb-free package

Symbol

Outline

Absolute Maximum Ratings ($T_a=25^\circ\text{C}$)

Parameter	Symbol	Limits	Unit
Collector-Base Voltage	V_{CB0}	180	V
Collector-Emitter Voltage	V_{CEO}	160	V
Emitter-Base Voltage	V_{EBO}	5	V
Collector Current (DC)	I_C	1.5	A
Collector Current (Pulse)	I_{CP}	3	A
Power Dissipation @ $T_A=25^\circ\text{C}$	P_D	1	W
Power Dissipation @ $T_C=25^\circ\text{C}$		20	W
Junction Temperature	T_j	150	$^\circ\text{C}$
Storage Temperature	T_{stg}	-55~+150	$^\circ\text{C}$



Characteristics (Ta=25°C)

Symbol	Min.	Typ.	Max.	Unit	Test Conditions
BV_{CBO}	180	-	-	V	$I_C=50\mu A, I_E=0$
BV_{CEO}	160	-	-	V	$I_C=1mA, I_B=0$
BV_{EBO}	5	-	-	V	$I_E=50\mu A, I_C=0$
I_{CBO}	-	-	1	μA	$V_{CB}=160V, I_E=0$
I_{EBO}	-	-	1	μA	$V_{EB}=4V, I_C=0$
* $V_{CE(sat)}$	-	-	0.6	V	$I_C=1A, I_B=100mA$
* $V_{BE(on)}$	-	-	1.5	V	$V_{CE}=5V, I_C=150mA$
h_{FE1}	82	-	320	-	$V_{CE}=5V, I_C=150mA$
h_{FE2}	30	-	-	-	$V_{CE}=5V, I_C=500mA$
f_T	-	140	-	MHz	$V_{CE}=5V, I_C=150mA$
Cob	-	27	-	pF	$V_{CB}=10V, I_E=0, f=1MHz$

*Pulse Test: Pulse Width $\leq 380\mu s$, Duty Cycle $\leq 2\%$

Classification of $h_{FE} 1$

Rank	P	Q	R
Range	82~180	120~200	180~320

Characteristic Curves

Current Gain vs Collector Current

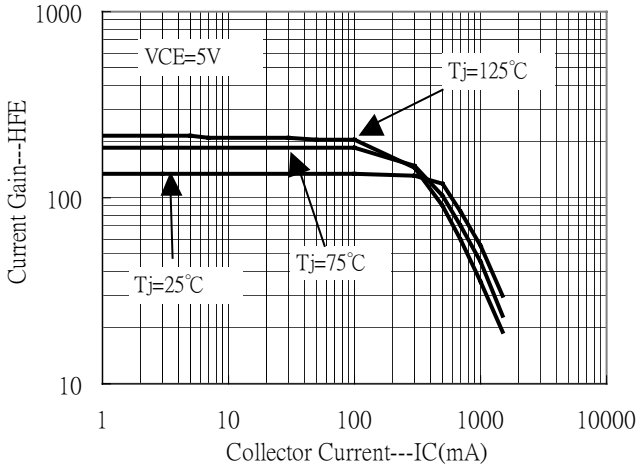

Saturation Voltage vs Collector Current

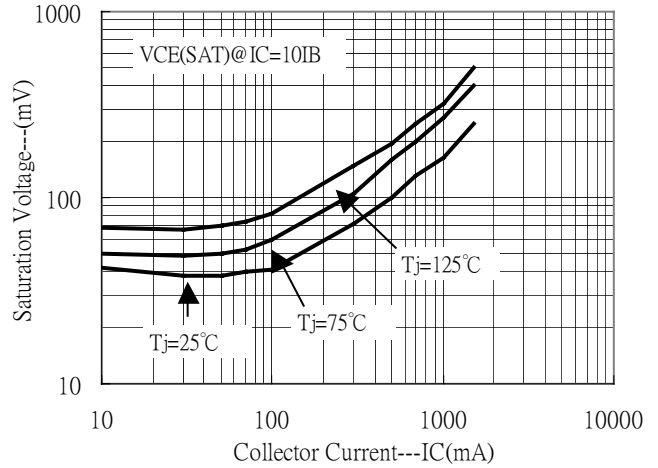

Saturation Voltage vs Collector Current

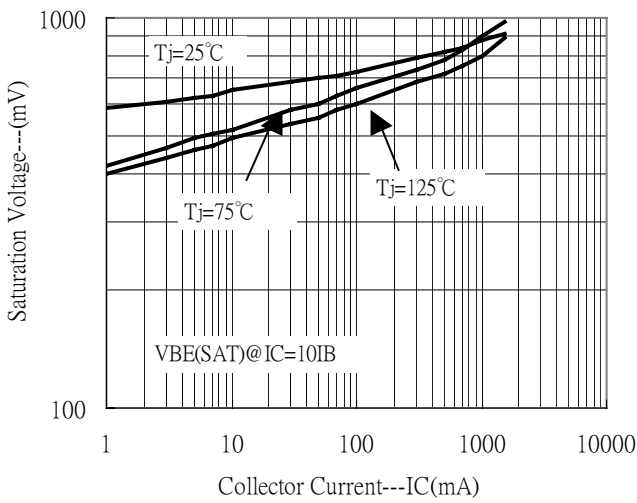

On Voltage vs Collector Current

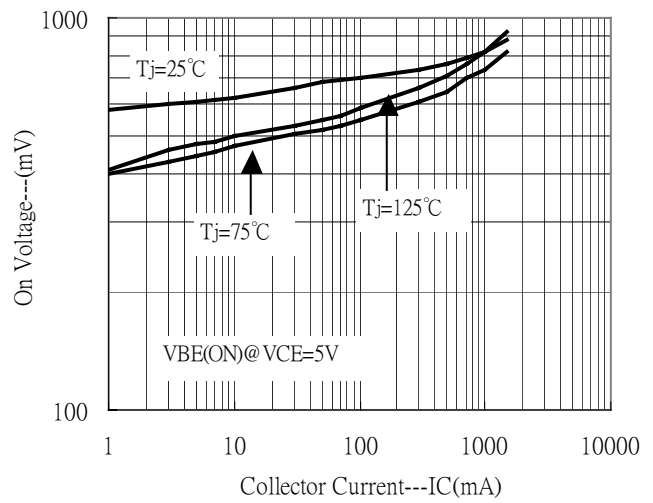

Power Derating Curve

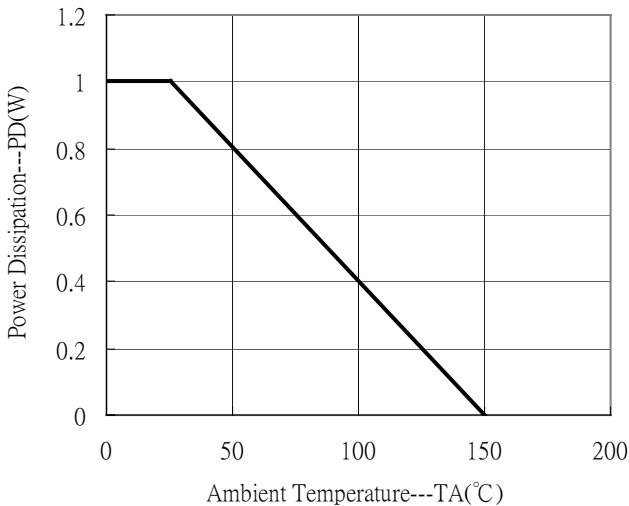

Power Derating Curve

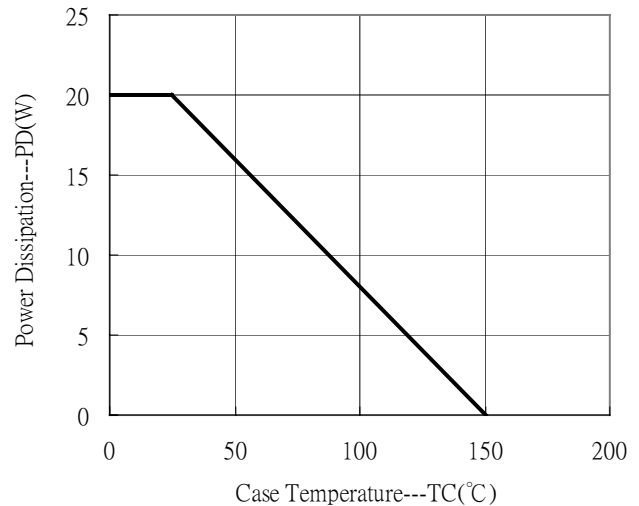

TO-126ML Dimension

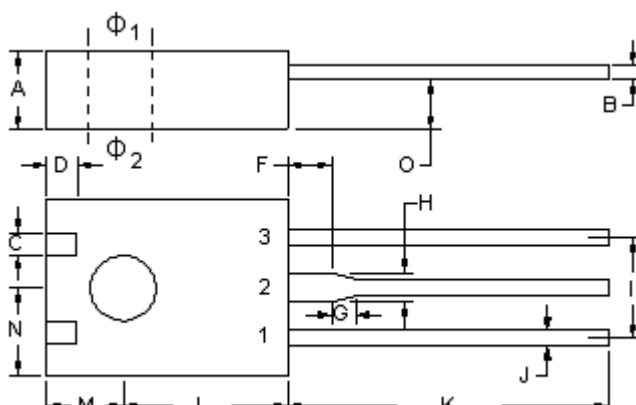

Marking:

D1857A

Style: Pin 1. Emitter 2. Collector 3. Base

3-Lead TO-126ML Plastic Package
 CYStek Package Code: D3

*: Typical

DIM	Inches		Millimeters		DIM	Inches		Millimeters	
	Min.	Max.	Min.	Max.		Min.	Max.	Min.	Max.
A	0.1356	0.1457	3.44	3.70	H	0.0462	0.0562	1.17	1.42
B	0.0170	0.0272	0.43	0.69	I	-	*0.1795	-	*4.56
C	0.0344	0.0444	0.87	1.12	J	0.0268	0.0331	0.68	0.84
D	0.0501	0.0601	1.27	1.52	K	0.5512	0.5906	14.00	15.00
Φ ₁	0.1220	0.1299	3.10	3.30	L	0.2903	0.3003	7.37	7.62
Φ ₂	0.1181	0.1260	3.00	3.20	M	0.1378	0.1478	3.50	3.75
F	0.0737	0.0837	1.87	2.12	N	0.1525	0.1625	3.87	4.12
G	0.0294	0.0494	0.74	1.25	O	0.0740	0.0842	1.88	2.14

Notes: 1. Controlling dimension: millimeters.
 2. Maximum lead thickness includes lead finish thickness, and minimum lead thickness is the minimum thickness of base material.
 3. If there is any question with packing specification or packing method, please contact your local CYStek sales office.

Material:

- Lead: 42 Alloy ; solder plating
- Mold Compound: Epoxy resin family, flammability solid burning class: UL94V-0

Important Notice:

- All rights are reserved. Reproduction in whole or in part is prohibited without the prior written approval of CYStek.
- CYStek reserves the right to make changes to its products without notice.
- CYStek **semiconductor products are not warranted to be suitable for use in Life-Support Applications, or systems.**
- CYStek assumes no liability for any consequence of customer product design, infringement of patents, or application assistance.