

### Analog Peripherals

#### 12-Bit ADC

- $\pm 1$  LSB INL; no missing codes
- Programmable throughput up to 100 ksp/s
- 8 external inputs; programmable as single-ended or differential
- Programmable amplifier gain: 16, 8, 4, 2, 1, 0.5
- Data-dependent windowed interrupt generator
- Built-in temperature sensor ( $\pm 3$  °C)

#### 8-Bit ADC

- $\pm 1$  LSB INL; no missing codes
- Programmable throughput up to 500 ksp/s
- 8 external inputs
- Programmable amplifier gain: 4, 2, 1, 0.5

#### Two 12-Bit DACs

- Can synchronize outputs to timers for jitter-free waveform generation

#### Two Comparators

#### Internal Voltage Reference

#### V<sub>DD</sub> Monitor/Brown-out Detector

#### On-Chip JTAG Debug & Boundary Scan

- On-chip debug circuitry facilitates full speed, non-intrusive in-system debug (no emulator required)
- Provides breakpoints, single stepping, watchpoints, stack monitor
- Inspect/modify memory and registers
- Real-time instruction trace buffer
- IEEE1149.1 compliant boundary scan

### High-Speed 8051 $\mu$ C Core

- Pipelined instruction architecture; executes 70% of instructions in 1 or 2 system clocks
- Up to 50 MIPS throughput with 50 MHz system clock
- Expanded interrupt handler

### Memory

- 8448 bytes data RAM
- 128 kB Flash; in-system programmable in 1024-byte sectors (1024 bytes are reserved)
- External parallel data memory interface

### Digital Peripherals

- 64 port I/O; all are 5 V tolerant
- Hardware SMBus™ (I2C™ compatible), SPI™, and two UART serial ports available concurrently
- Programmable 16-bit counter/timer array with six capture/compare modules
- 5 general-purpose 16-bit counter/timers
- Dedicated watchdog timer; bidirectional reset
- Real-time clock mode using a timer or PCA

### Clock Sources

- Internal oscillator: 24.5 MHz, 2% accuracy supports UART operation
- On-chip programmable PLL: up to 50 MHz
- External oscillator: Crystal, RC, C, or Clock

### Supply Voltage: 2.7 to 3.6 V

- Typical operating current: 25 mA at 50 MHz
- Typical stop mode current: <0.1  $\mu$ A

### 100-Pin TQFP

Temperature Range: -40 to +85 °C

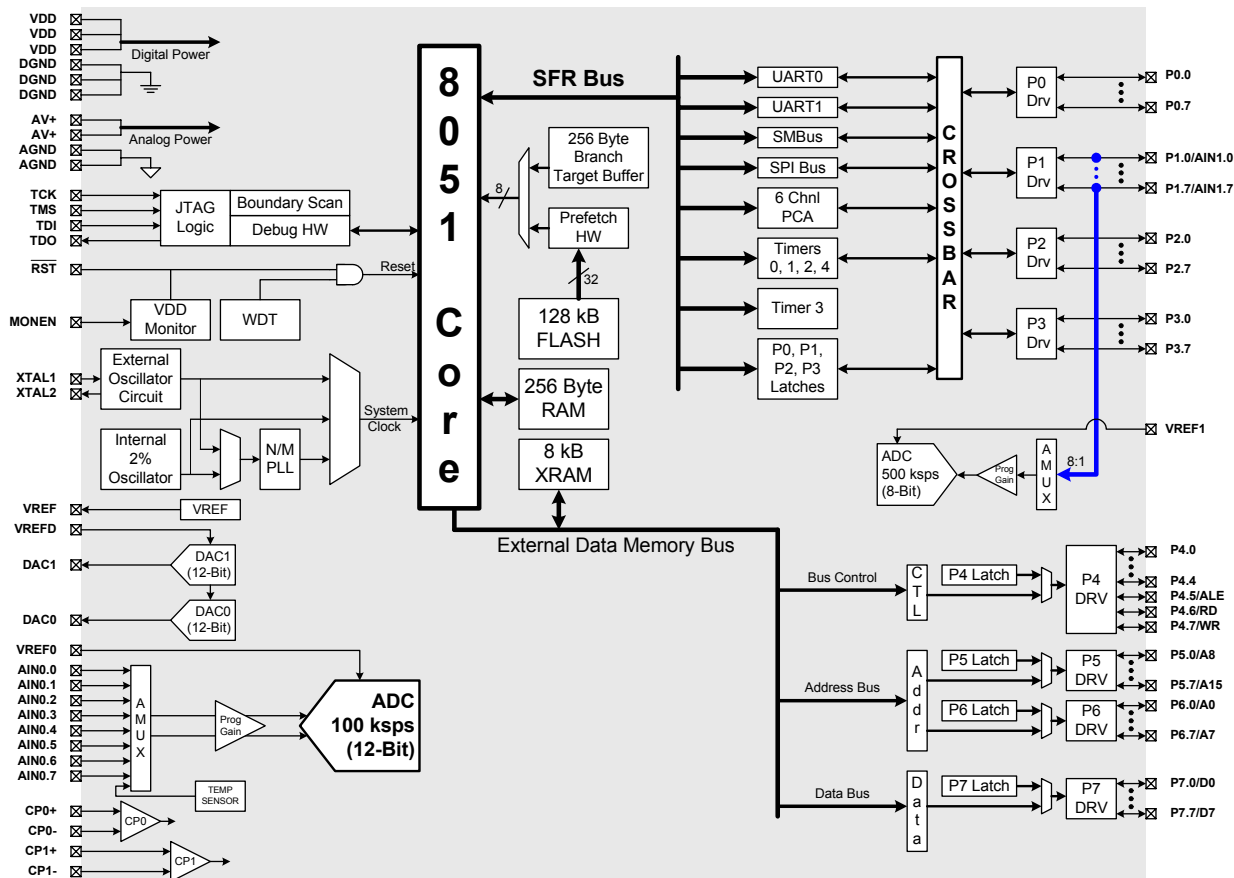

## Selected Electrical Specifications

( $T_A = -40$  to  $+85$  °C,  $V_{DD} = 2.7$  V unless otherwise specified)

PARAMETER	CONDITIONS	MIN	TYP	MAX	UNITS
<b>GLOBAL CHARACTERISTICS</b>					
Supply Voltage		2.7		3.6	V
Supply Current (CPU active)	Clock = 50 MHz Clock = 1 MHz Clock = 32 kHz		25 0.5 16		mA mA μA
Supply Current (shutdown)	Oscillator off; $V_{DD}$ Monitor Enabled Oscillator off; $V_{DD}$ Monitor Disabled		10 <0.1		μA μA
Clock Frequency Range		DC		50	MHz
<b>INTERNAL CLOCKS</b>					
Oscillator Frequency		24.0	24.5	25.0	MHz
PLL Frequency		48	49	50	MHz
<b>A/D CONVERTER</b>					
Resolution			12		bits
Integral Nonlinearity				±1	LSB
Differential Nonlinearity	Guaranteed Monotonic			±1	LSB
Signal-to-Noise Plus Distortion		66	69		dB
Throughput Rate				100	ksps
<b>D/A CONVERTERS</b>					
Resolution			12		bits
Differential Nonlinearity	Guaranteed Monotonic			±1	LSB
Output Settling Time			10		μS
<b>COMPARATORS</b>					
Supply Current	(each comparator)		1.5		μA
Response Time	(CP+) – (CP-) = 100 mV		4.0		μS

## Package Information

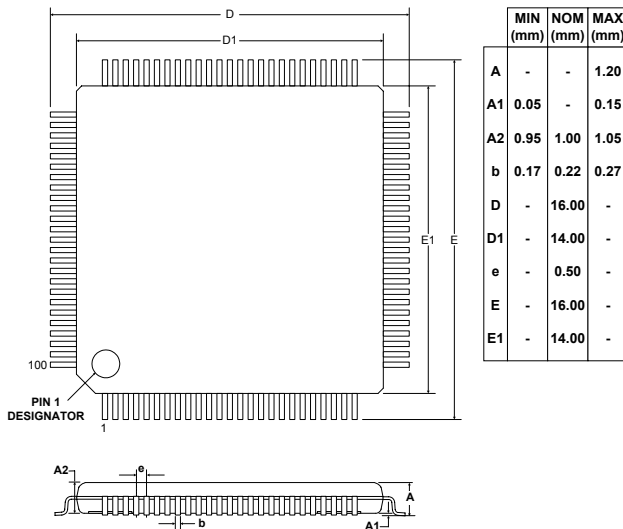

## C8051F120DK Development Kit

