

# CGH27015F

15 W, 2300-2900 MHz, 28V, GaN HEMT for WiMAX

Cree's CGH27015 is a gallium nitride (GaN) high electron mobility transistor designed specifically for high efficiency, high gain and wide bandwidth capabilities, which makes the CGH27015 ideal for 2.3 to 2.9GHz WiMAX and BWA amplifier applications. The transistor is available in ceramic, metal flange package.



Package Type: 440166  
PN: CGH27015F

## Typical Performance 2.4-2.7 GHz ( $T_c = 25^\circ\text{C}$ )

Parameter	2.4 GHz	2.5 GHz	2.6 GHz	2.7 GHz	Units
Small Signal Gain	14.5	14.5	14.5	14.5	dB
$P_{OUT}$ @ 2.0 % EVM	34.0	34.0	34.0	34.0	dBm
Drain Efficiency @ 2.0 % EVM	23.0	24.0	24.0	23.0	%
Input Return Loss	7.0	6.0	5.0	5.0	dB
Output Return Loss	5.0	6.0	7.0	7.0	dB

### Note:

Measured in the CGH27015F-TB amplifier circuit, under 802.16-2004 OFDM, 3.5 MHz Channel BW, 1/4 Cyclic Prefix, 64 QAM Modulated Burst, 5 ms Burst, Symbol Length of 59, Coding Type RS-CC, Coding Rate Type 2/3.

## Features

- 2.3 - 2.9 GHz Operation
- >14.5 dB Small Signal Gain
- >2.0 W  $P_{OUT}$  at 2.0 % EVM
- 25 % Efficiency at 2.5 % EVM
- WiMAX Fixed Access 802.16-2004 OFDM
- WiMAX Mobile Access 802.16e OFDMA





## Absolute Maximum Ratings (not simultaneous) at 25 °C Case Temperature

Parameter	Symbol	Rating	Units
Drain-Source Voltage	$V_{DSS}$	84	Volts
Gate-to-Source Voltage	$V_{GS}$	-10, +2	Volts
Storage Temperature	$T_{STG}$	-55, +150	°C
Operating Junction Temperature	$T_J$	175	°C
Soldering Temperature	$T_S$	245	°C
Thermal Resistance, Junction to Case <sup>1</sup>	$R_{\theta JC}$	5.0	°C/W

Note:

<sup>1</sup> Measured for the CGH27015F at  $P_{DISS} = 14W$ .

## Electrical Characteristics ( $T_c = 25^\circ C$ )

Characteristics	Symbol	Min.	Typ.	Max.	Units	Conditions
<b>DC Characteristics<sup>4</sup></b>						
Gate Threshold Voltage	$V_{GS(th)}$	-3.0	-2.5	-1.8	VDC	$V_{DS} = 10 V, I_D = 3.6 mA$
Gate Quiescent Voltage	$V_{GS(Q)}$	-	-2.45	-	VDC	$V_{DS} = 28 V, I_D = 60 mA$
Saturated Drain Current	$I_{DS}$	2.4	2.7	-	A	$V_{DS} = 6.0 V, V_{GS} = 2.0 V$
Drain-Source Breakdown Voltage	$V_{BR}$	84	100	-	VDC	$V_{GS} = -8 V, I_D = 3.6 mA$
Case Operating Temperature	$T_C$	-10	-	+105	°C	
Screw Torque	T	-	-	60	in-oz	Reference 440166 Package Revision 3
<b>RF Characteristics<sup>2,3</sup> (<math>T_c = 25^\circ C, F_0 = 2.5 GHz</math> unless otherwise noted)</b>						
Small Signal Gain	$G_{SS}$	13	14.5	-	dB	$V_{DD} = 28 V, I_{DQ} = 60 mA$
Drain Efficiency <sup>1</sup>	$\eta$	20	21	-	%	$V_{DD} = 28 V, I_{DQ} = 60 mA, P_{AVE} = 2.0 W$
Back-Off Error Vector Magnitude	$EVM_1$	-	2.5	-	%	$V_{DD} = 28 V, I_{DQ} = 60 mA, P_{AVE} = 18 dBm$
Error Vector Magnitude	$EVM_2$	-	2.0	-	%	$V_{DD} = 28 V, I_{DQ} = 60 mA, P_{AVE} = 2.0 W$
Output Mismatch Stress	VSWR	-	10:1	-	$\Psi$	No damage at all phase angles, $V_{DD} = 28 V, I_{DQ} = 60 mA,$ $P_{AVE} = 2.0 W$ OFDM $P_{AVE}$
<b>Dynamic Characteristics</b>						
Input Capacitance	$C_{GS}$	-	5.00	-	pF	$V_{DS} = 28 V, V_{gs} = -8 V, f = 1 MHz$
Output Capacitance	$C_{DS}$	-	1.32	-	pF	$V_{DS} = 28 V, V_{gs} = -8 V, f = 1 MHz$
Feedback Capacitance	$C_{GD}$	-	0.43	-	pF	$V_{DS} = 28 V, V_{gs} = -8 V, f = 1 MHz$

Notes:

<sup>1</sup> Drain Efficiency =  $P_{OUT} / P_{DC}$

<sup>2</sup> Under 802.16-2004 OFDM, 3.5 MHz Channel BW, 1/4 Cyclic Prefix, 64 QAM Modulated Burst, 5 ms Burst, Symbol Length of 59, Coding Type RS-CC, Coding Rate Type 2/3.

<sup>3</sup> Measured in the CGH27015F-TB test fixture.

<sup>4</sup> Measured on wafer prior to packaging.

## Typical Performance Data

### Typical EVM and Efficiency of CGH27015F in Broadband Amplifier Circuit at 2.5 GHz F=2.5 GHz, 802.16-2004 OFDM, P/A=9.8 dB

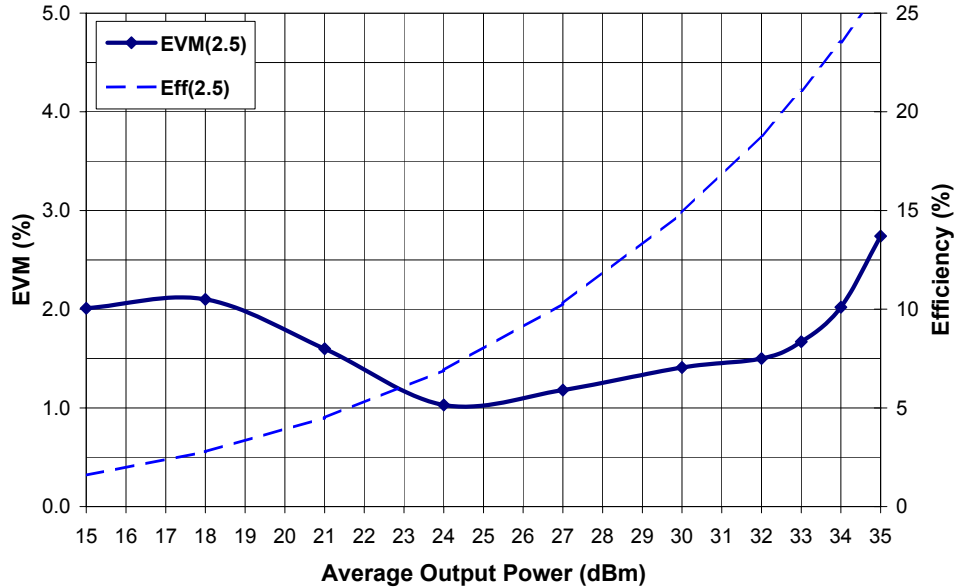

Note:

Under 802.16-2004 OFDM, 3.5 MHz Channel BW, 1/4 Cyclic Prefix, 64 QAM Modulated Burst, Symbol Length of 59, Coding Type RS-CC, Coding Rate Type 2/3.

### Typical Constellation Chart, Spectral Mask, and EVM of CGH27015F in Broadband Amplifier Circuit at 2.5 GHz $V_{DD} = 28 V$ , $I_{DQ} = 60 mA$ , $P_{AVE} = 2.0 W$

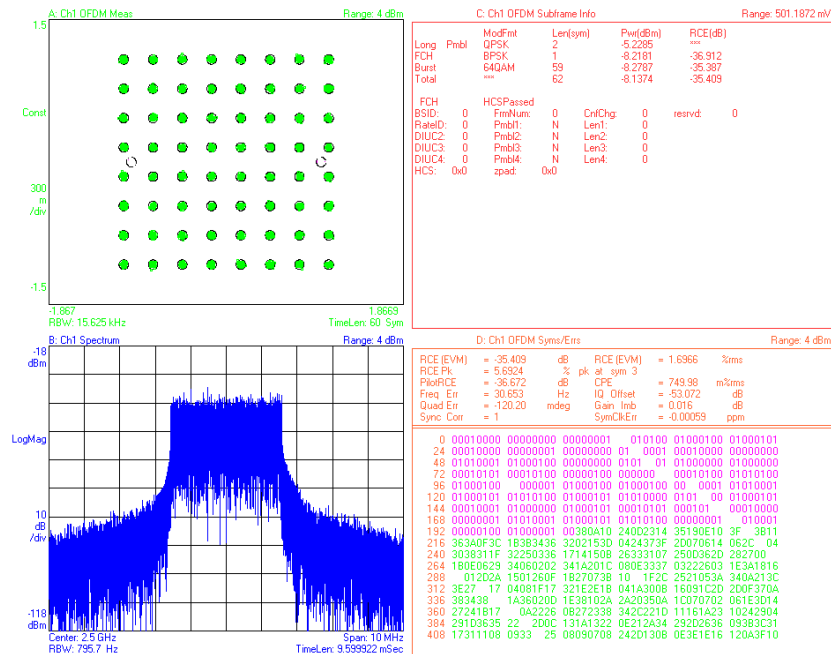

## Typical Performance Data

**Typical EVM and Efficiency at 22dB and 33 dB vs Frequency of CGH27015F in Broadband Amplifier Circuit**

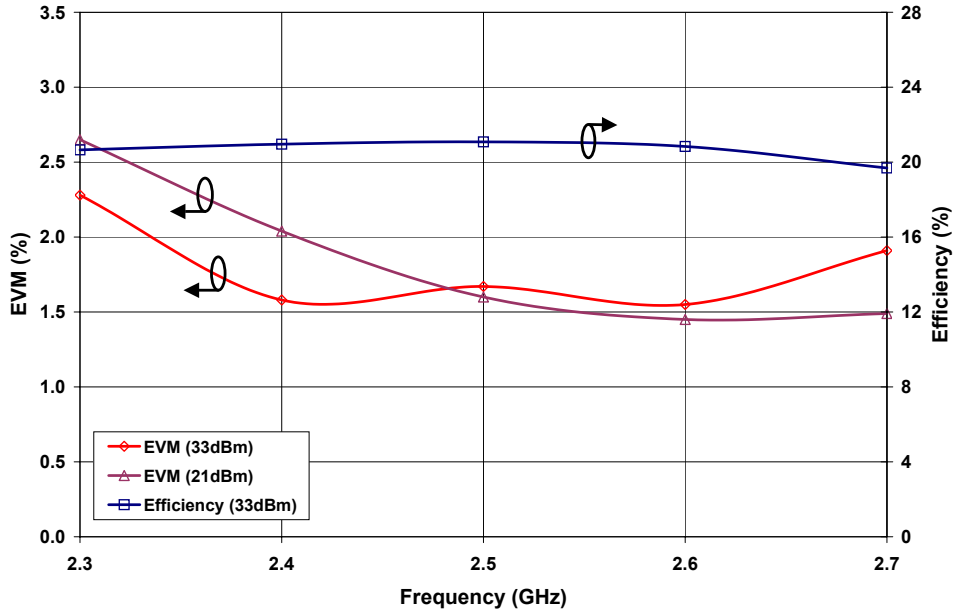

Note:

Under 802.16 OFDM, 3.5 MHz Channel BW, 1/4 Cyclic Prefix, 64 QAM Modulated Burst, Symbol Length of 59, Coding Type RS-CC, Coding Rate Type 2/3.

**Performance of CGH27015F in Broadband Amplifier Circuit**  
 $V_{DD} = 28 \text{ V}$ ,  $I_{DQ} = 60 \text{ mA}$ , OFDM BW = 3.5 MHz

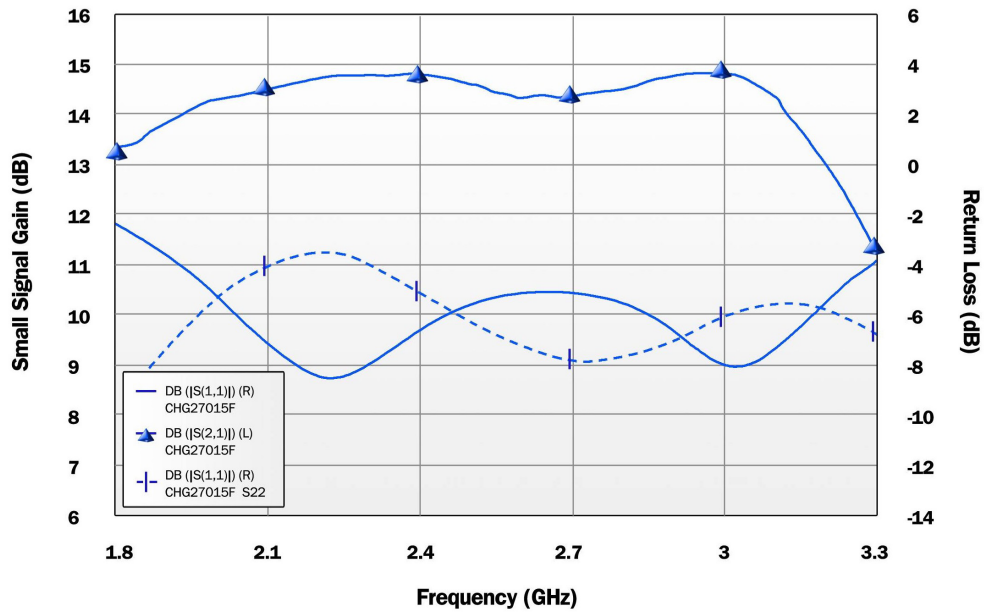

# Product Dimensions CGH27015F (Package Type — 440166)

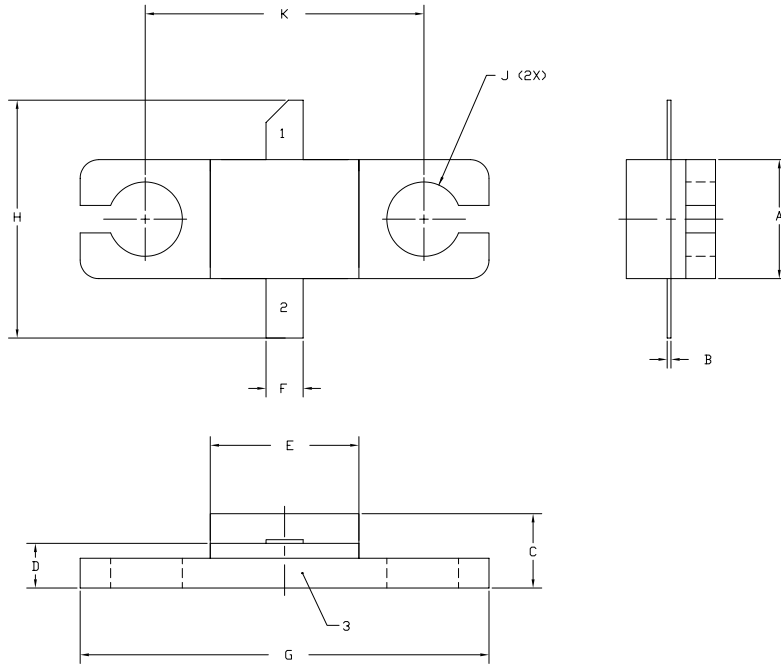

- NOTES:
1. DIMENSIONING AND TOLERANCING PER ANSI Y14.5M, 1982.
  2. CONTROLLING DIMENSION: INCH.
  3. ADHESIVE FROM LID MAY EXTEND A MAXIMUM OF 0.020" BEYOND EDGE OF LID.
  4. LID MAY BE MISALIGNED TO THE BODY OF THE PACKAGE BY A MAXIMUM OF 0.008" IN ANY DIRECTION.
  5. ALL PLATED SURFACES ARE Ni/AU

DIM	INCHES		MILLIMETERS	
	MIN	MAX	MIN	MAX
A	0.155	0.165	3.94	4.19
B	0.004	0.006	0.10	0.15
C	0.115	0.135	2.92	3.43
D	0.057	0.067	1.45	1.70
E	0.195	0.205	4.95	5.21
F	0.045	0.055	1.14	1.40
G	0.545	0.555	13.84	14.09
H	0.280	0.360	7.87	8.38
J	∅ .100		2.54	
K	0.375		9.53	

PIN 1. GATE  
 PIN 2. DRAIN  
 PIN 3. SOURCE

## CGH27015F-TB Demonstration Amplifier Circuit Schematic

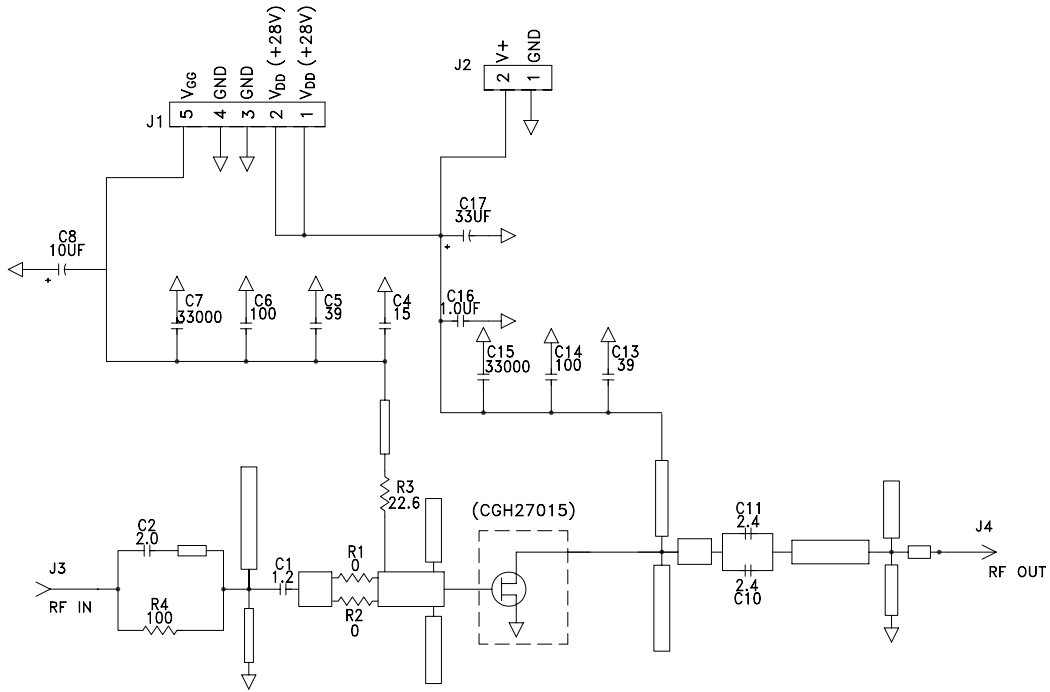

## CGH27015F-TB Demonstration Amplifier Circuit Outline

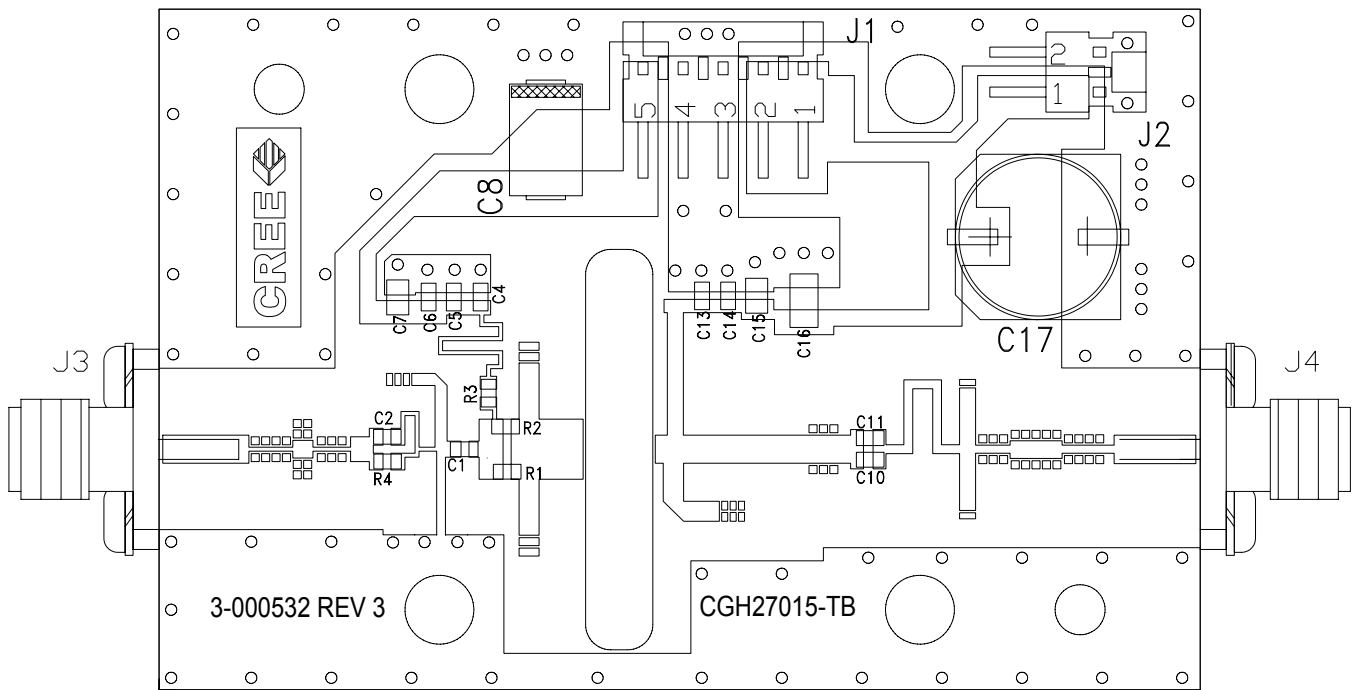

## CGH27015F-TB Demonstration Amplifier Circuit Bill of Materials

Designator	Description	Qty
R1,R2	RES,1/16W,0603,1%,0 OHMS	2
R4	RES,1/16W,0603,1%,100 OHMS	1
R3	RES,1/16W,0603,1%,22.6 OHMS	1
C6	CAP, 470PF, 5%,100V, 0603	1
C17	CAP, 33 UF, 20%, G CASE	1
C16	CAP, 1.0UF, 100V, 10%, X7R, 1210	1
C8	CAP 10UF 16V TANTALUM	1
C14	CAP, 100.0pF, +/-5%, 0603	1
C4	CAP, 15pF, +/-5%, 0603	1
C1	CAP, 1.2pF, +/-0.1pF, 0603	1
C2	CAP, 2.0pF, +/-0.1pF, 0603	1
C10,C11	CAP, 2.4pF,+/-0.1pF, 0603	2
C5,C13	CAP, 39pF, +/-5%, 0603	2
C7,C15	CAP,33000PF, 0805,100V, X7R	2
J3,J4	CONN SMA STR PANEL JACK RECP	1
J2	HEADER RT>PLZ.1CEN LK 2 POS	1
J1	HEADER RT>PLZ .1CEN LK 5POS	1
Q1	CGH27015F	1

## CGH27015F-TB Demonstration Amplifier Circuit

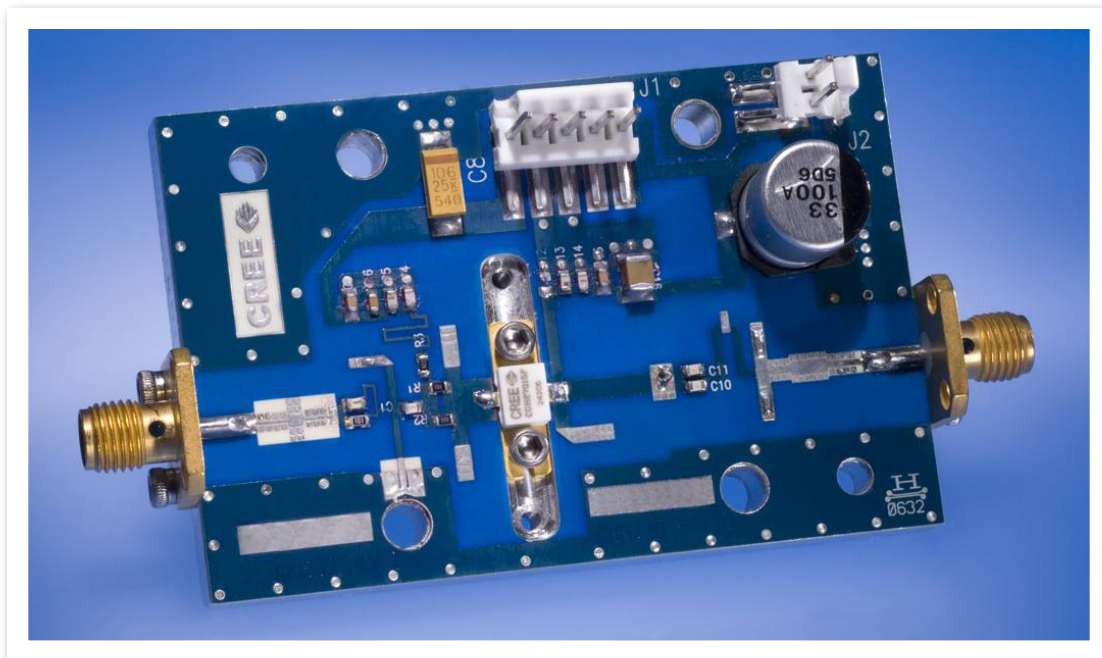



## Disclaimer

---

Specifications are subject to change without notice. Cree, Inc. believes the information contained within this data sheet to be accurate and reliable. However, no responsibility is assumed by Cree for any infringement of patents or other rights of third parties which may result from its use. No license is granted by implication or otherwise under any patent or patent rights of Cree. Cree makes no warranty, representation or guarantee regarding the suitability of its products for any particular purpose. "Typical" parameters are the average values expected by Cree in large quantities and are provided for information purposes only. These values can and do vary in different applications and actual performance can vary over time. All operating parameters should be validated by customer's technical experts for each application. Cree products are not designed, intended or authorized for use as components in applications intended for surgical implant into the body or to support or sustain life, in applications in which the failure of the Cree product could result in personal injury or death or in applications for planning, construction, maintenance or direct operation of a nuclear facility.

For more information, please contact:

Cree, Inc.  
4600 Silicon Drive  
Durham, NC 27703  
[www.cree.com/wireless](http://www.cree.com/wireless)

Ryan Baker  
Marketing  
Cree, Wireless Devices  
919.287.7816

Tom Dekker  
Sales Director  
Cree, Wireless Devices  
919.313.5639