

GENERAL DESCRIPTION

This high voltage MOSFET uses an advanced termination scheme to provide enhanced voltage-blocking capability without degrading performance over time. In addition, this advanced MOSFET is designed to withstand high energy in avalanche and commutation modes. The new energy efficient design also offers a drain-to-source diode with a fast recovery time. Designed for high voltage, high speed switching applications in power supplies, converters and PWM motor controls, these devices are particularly well suited for bridge circuits where diode speed and commutating safe operating areas are critical and offer additional and safety margin against unexpected voltage transients.

FEATURES

- ◆ Robust High Voltage Termination
- ◆ Avalanche Energy Specified
- ◆ Source-to-Drain Diode Recovery Time Comparable to a Discrete Fast Recovery Diode
- ◆ Diode is Characterized for Use in Bridge Circuits
- ◆ I_{DSS} and $V_{DS(on)}$ Specified at Elevated Temperature

PIN CONFIGURATION

TO-220
Front View

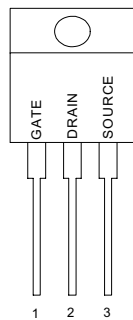

SYMBOL

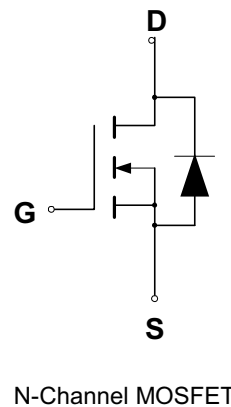

ABSOLUTE MAXIMUM RATINGS

Rating	Symbol	Value	Unit
Drain to Current — Continuous	I_D	6.0	A
— Pulsed	I_{DM}	18	
Gate-to-Source Voltage — Continue	V_{GS}	± 20	V
— Non-repetitive	V_{GSM}	± 40	V
Total Power Dissipation	P_D	125	W
Derate above 25°C		1.0	W/°C
Operating and Storage Temperature Range	T_J, T_{STG}	-55 to 150	°C
Single Pulse Drain-to-Source Avalanche Energy — $T_J = 25^\circ\text{C}$ ($V_{DD} = 100\text{V}, V_{GS} = 10\text{V}, I_L = 20\text{A}, L = 10\text{mH}, R_G = 25\Omega$)	E_{AS}	405	mJ
Thermal Resistance — Junction to Case	θ_{JC}	1.0	°C/W
— Junction to Ambient	θ_{JA}	62.5	
Maximum Lead Temperature for Soldering Purposes, 1/8" from case for 10 seconds	T_L	260	°C

(1) $V_{DD} = 50\text{V}, I_D = 10\text{A}$

(2) Pulse Width and frequency is limited by $T_{J(max)}$ and thermal response

ELECTRICAL CHARACTERISTICS

Unless otherwise specified, $T_J = 25^\circ\text{C}$.

Characteristic	Symbol	Min	Typ	Max	Units	
Drain-Source Breakdown Voltage ($V_{GS} = 0\text{ V}$, $I_D = 250\ \mu\text{A}$)	$V_{(BR)DSS}$	600			V	
Drain-Source Leakage Current ($V_{DS} = 600\text{ V}$, $V_{GS} = 0\text{ V}$) ($V_{DS} = 600\text{ V}$, $V_{GS} = 0\text{ V}$, $T_J = 125^\circ\text{C}$)	I_{DSS}			1.0 50	μA	
Gate-Source Leakage Current-Forward ($V_{gsf} = 20\text{ V}$, $V_{DS} = 0\text{ V}$)	I_{GSSF}			100	nA	
Gate-Source Leakage Current-Reverse ($V_{gsr} = 20\text{ V}$, $V_{DS} = 0\text{ V}$)	I_{GSSR}			100	nA	
Gate Threshold Voltage ($V_{DS} = V_{GS}$, $I_D = 250\ \mu\text{A}$)	$V_{GS(th)}$	2.0	3.0	4.0	V	
Static Drain-Source On-Resistance ($V_{GS} = 10\text{ V}$, $I_D = 3.0\text{A}$) *	$R_{DS(on)}$		0.94	1.2	Ω	
Drain-Source On-Voltage ($V_{GS} = 10\text{ V}$) ($I_D = 6.0\text{ A}$)	$V_{DS(on)}$		6.0	8.6	V	
Forward Transconductance ($V_{DS} = 15\text{ V}$, $I_D = 3.0\text{A}$) *	g_{FS}	2.0	5.5		S	
Input Capacitance	$(V_{DS} = 25\text{ V}$, $V_{GS} = 0\text{ V}$, $f = 1.0\text{ MHz}$)	C_{iss}		1498	2100	pF
Output Capacitance		C_{oss}		158	220	pF
Reverse Transfer Capacitance		C_{rss}		29	60	pF
Turn-On Delay Time	$(V_{DD} = 300\text{ V}$, $I_D = 6.0\text{ A}$, $V_{GS} = 10\text{ V}$, $R_G = 9.1\Omega$) *	$t_{d(on)}$		14	30	ns
Rise Time		t_r		19	40	ns
Turn-Off Delay Time		$t_{d(off)}$		40	80	ns
Fall Time		t_f		26	55	ns
Total Gate Charge	$(V_{DS} = 300\text{ V}$, $I_D = 6.0\text{ A}$, $V_{GS} = 10\text{ V}$) *	Q_g		35.5	50	nC
Gate-Source Charge		Q_{gs}		8.1		nC
Gate-Drain Charge		Q_{gd}		14.1		nC
Internal Drain Inductance (Measured from the drain lead 0.25" from package to center of die)	L_D		4.5		nH	
Internal Drain Inductance (Measured from the source lead 0.25" from package to source bond pad)	L_S		7.5		nH	
SOURCE-DRAIN DIODE CHARACTERISTICS						
Forward On-Voltage(1)	$(I_S = 6.0\text{ A}$, $dI_S/dt = 100\text{A}/\mu\text{s}$)	V_{SD}		0.83	1.2	V
Forward Turn-On Time		t_{on}		**		ns
Reverse Recovery Time		t_{rr}		266		ns

* Pulse Test: Pulse Width $\leq 300\mu\text{s}$, Duty Cycle $\leq 2\%$

** Negligible, Dominated by circuit inductance

TYPICAL ELECTRICAL CHARACTERISTICS

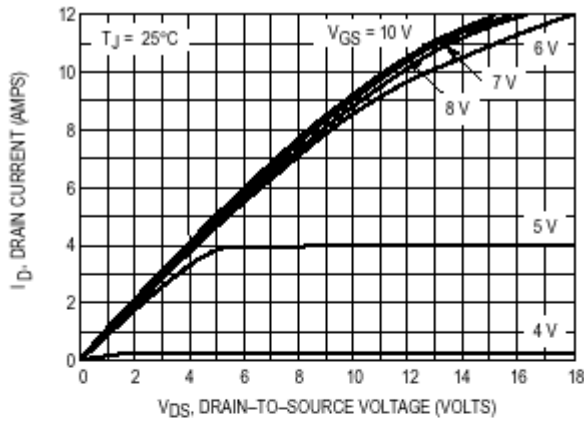

Figure 1. On-Region Characteristics

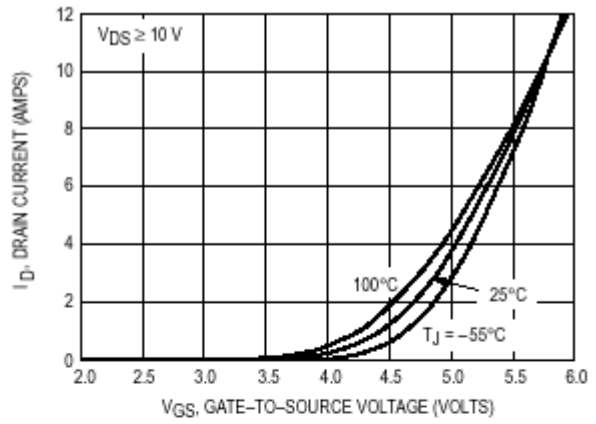

Figure 2. Transfer Characteristics

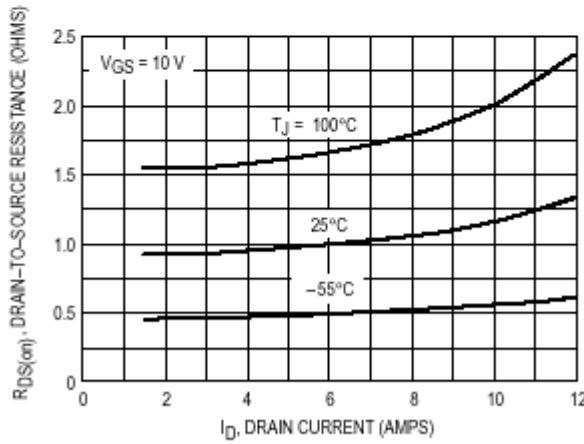

Figure 3. On-Resistance versus Drain Current and Temperature

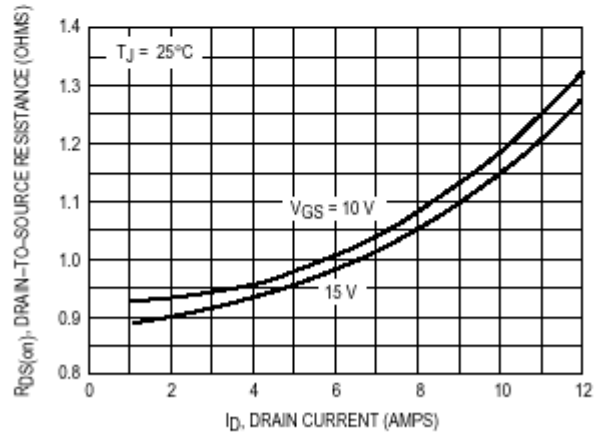

Figure 4. On-Resistance versus Drain Current and Gate Voltage

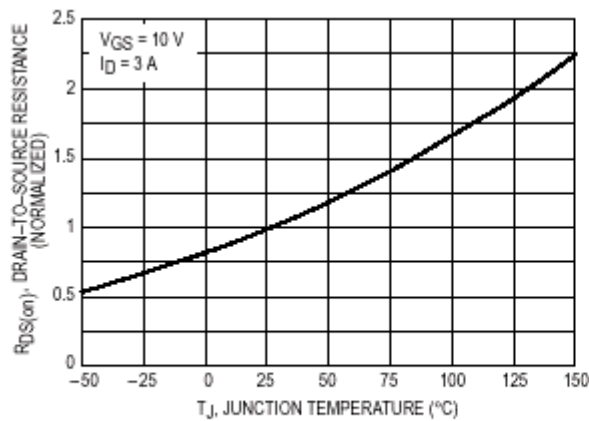

Figure 5. On-Resistance Variation with Temperature

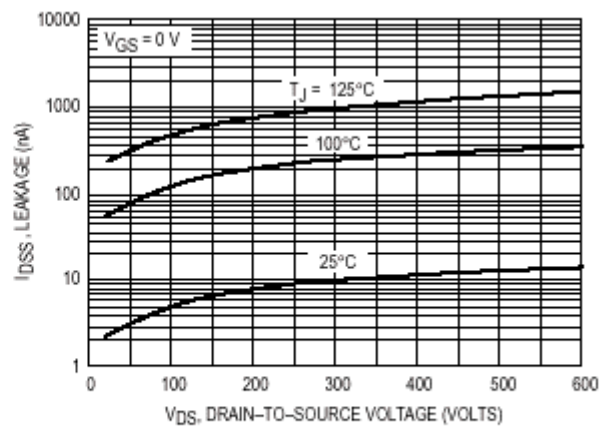
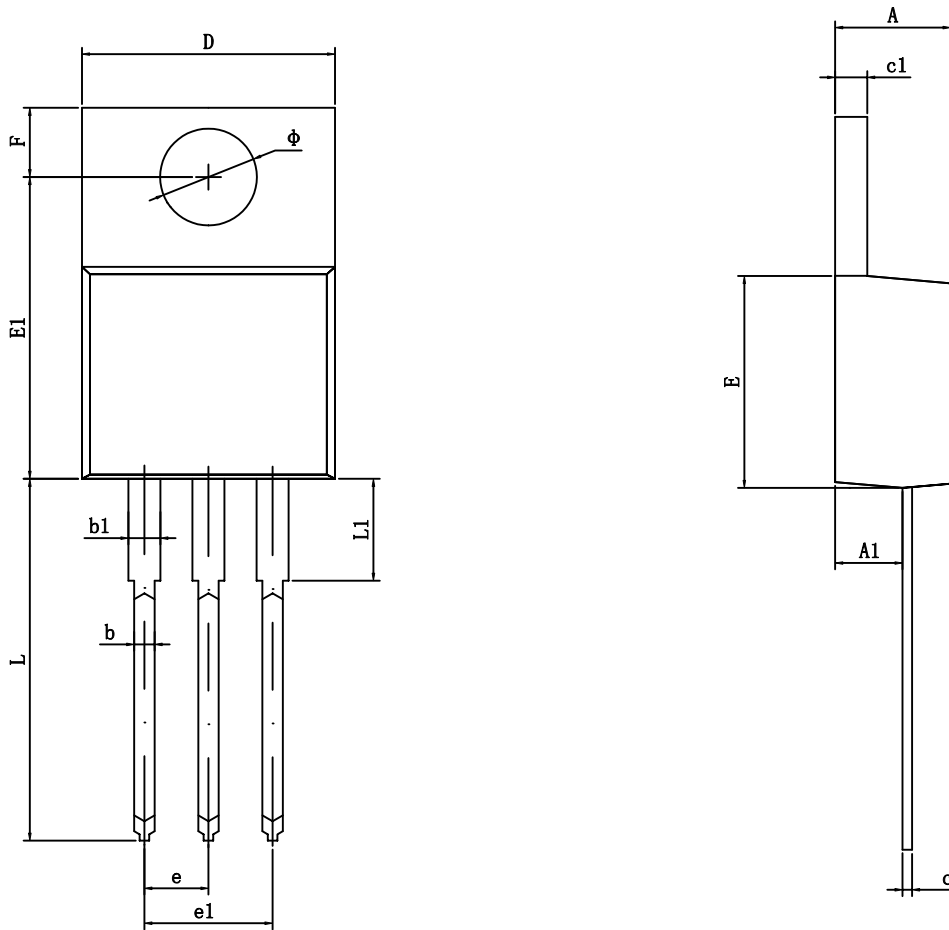

Figure 6. Drain-to-Source Leakage Current versus Voltage

TO-220 PACKAGE OUTLINE DIMENSIONS



Symbol	Dimensions In Millimeters		Dimensions In Inches	
	Min	Max	Min	Max
A	4.470	4.670	0.176	0.184
A1	2.520	2.820	0.099	0.111
b	0.710	0.910	0.028	0.036
b1	1.170	1.370	0.046	0.054
c	0.310	0.530	0.012	0.021
c1	1.170	1.370	0.046	0.054
D	10.010	10.310	0.394	0.406
E	8.500	8.900	0.335	0.350
E1	12.060	12.460	0.475	0.491
e	2.540TYP		0.100TYP	
e1	4.980	5.180	0.196	0.204
F	2.590	2.890	0.102	0.114
L	13.400	13.800	0.528	0.543
L1	3.560	3.960	0.140	0.156
ϕ	3.790	3.890	0.149	0.153