

CL - 304L

CL - 304L is a high - output GaAlAs IRED mounted in a low profile clear package. This IRED is both compact and easy to mount.

FEATURES

- Plastic mold package
- Peak emission wavelength $\lambda = 880\text{nm}$
- Long leads type 42.5mm

APPLICATIONS

- Optical switches

DIMENSIONS

(Unit : mm)

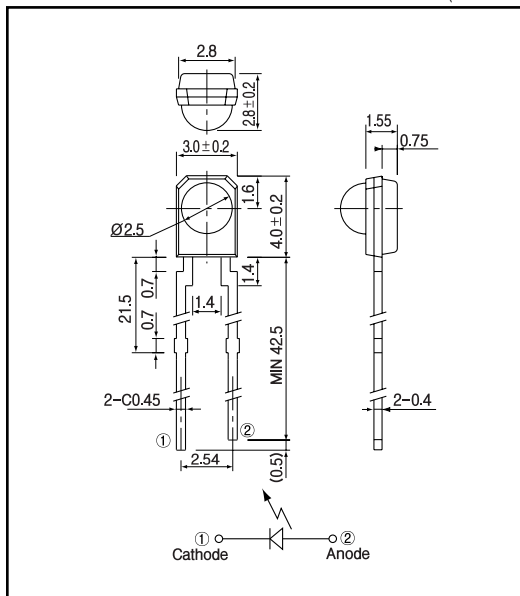

MAXIMUM RATINGS

($T_a = 25^\circ\text{C}$)

Item	Symbol	Rating	Unit
Reverse voltage	V_R	5	V
Forward current	I_F	50	mA
Power dissipation	P_D	100	mW
Pulse forward current ¹⁾	I_{FP}	0.5	A
Operating temp.	$T_{opr.}$	- 25 + 70	
Storage temp.	$T_{stg.}$	- 40 + 85	
Soldering temp. ²⁾	$T_{sol.}$	260	

¹⁾ pulse width : $t_w \leq 100 \mu\text{sec. period : } T = 10\text{msec.}$

²⁾ For MAX.5 seconds at the position of 2 mm from the package

ELECTRO-OPTICAL CHARACTERISTICS

($T_a = 25^\circ\text{C}$)

Item	Symbol	Conditions	Min.	Typ.	Max.	Unit.
Forward voltage	V_F	$I_F = 50\text{mA}$		1.5	2.0	V
Reverse current	I_R	$V_R = 5\text{V}$			10	μA
Peak emission wavelength	λ	$I_F = 50\text{mA}$		880		nm
Spectral bandwidth		$I_F = 50\text{mA}$		50		nm
Radiant intensity	P_D	$I_F = 50\text{mA}$		7.6		mV
Half angle				± 30		deg.

Infrared Emitting Diodes(GaAlAs)

CL - 304L

Power dissipation Vs. Ambient temperature

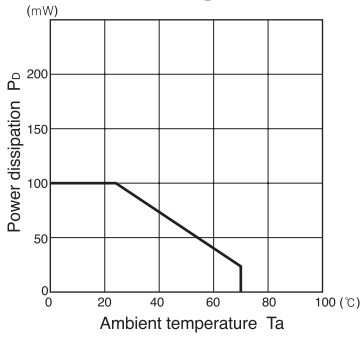

Radiant intensity Vs. Forward current

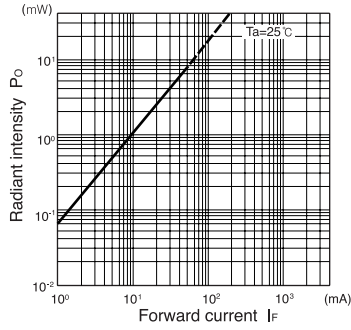

Relative radiant intensity Vs. Ambient temperature

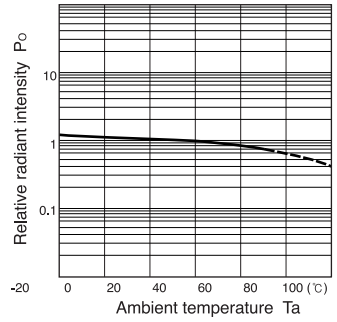

Relative intensity Vs. Wavelength

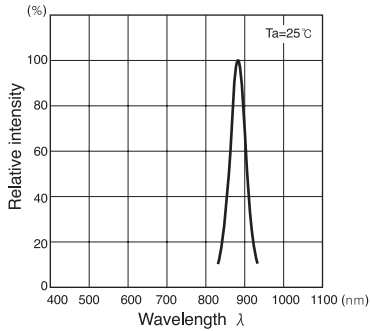

Forward current Vs. Forward voltage

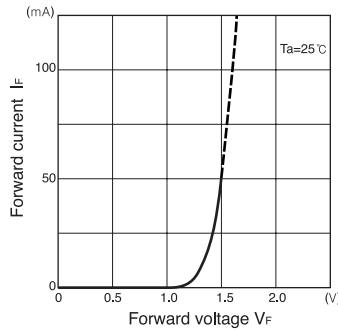

Radiant Pattern

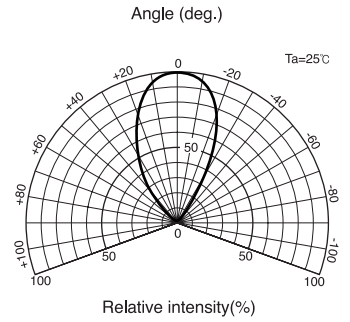

Relative radiant intensity Vs. Distance

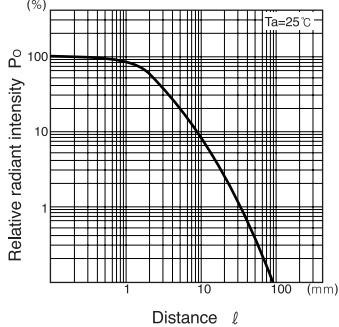

Relative radiant intensity Vs. Distance test method

