

### FEATURES

- Temperature-Compensated: 50ppm/°C
- Trimmed 0.5% Bandgap Reference
- Internal Amplifier with 150mA Capability
- Nominal Temperature Range Extended to 105°C
- Low Frequency Dynamic Output Impedance: < 150m
- Low Output Noise

### DESCRIPTION

Calogic's CL432 is a 3-terminal Adjustable Shunt Regulator highly accurate 1.25V bandgap reference with a 0.5% tolerance. The device offers thermal stability, wide operating current (100mA) and an extended temperature range of 0° to 105°C for operation in power supply applications. The CL432 offers a wide operating voltage range of up to 18V and is an excellent choice for voltage reference requirements in an isolated feedback circuit for 3.0V to 3.3V switching mode power supplies. The tight tolerance guarantees a lower design cost for the power supply manufacturer by virtually eliminating the need for an extra power supply manufacturing process of the power supply.

The device is housed in several package options to meet the designers criteria.

### ORDERING INFORMATION

Part	Package	Temperature Range
CL432LP	TO-92	0 to 105°C
CL432D	8-Pin Plastic SOIC	0 to 105°C
CL432VS	SOT-23	0 to 105°C
CL432S	SOT-89	0 to 105°C

### PIN CONFIGURATION (Top View)

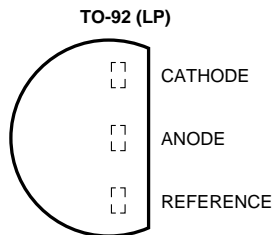

1G-33

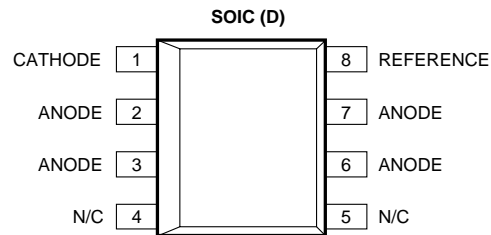

1G-34

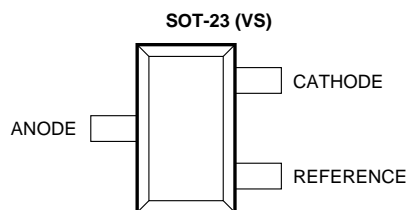

1J-22

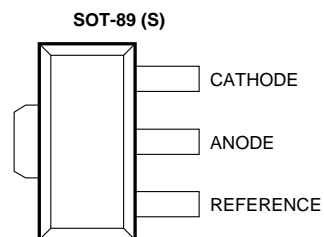

1G-35

**ABSOLUTE MAXIMUM RATINGS**

SYMBOL	PARAMETER	RATING	UNITS
V <sub>KA</sub>	Cathode-Anode Reverse Breakdown	18	V
I <sub>AK</sub>	Anode-Cathode Forward Current	1	A
I <sub>KA</sub>	Operating Cathode Current	100	mA
I <sub>REF</sub>	Reference Input Current	1	mA
P <sub>D</sub>	Continuous Power at 25°C		
	TO-92	775	mW
	8L SOIC	750	mW
	SOT-23	1000	mW
	SOT-89	200	mW
T <sub>J</sub>	Junction Temperature	150	°C
T <sub>STG</sub>	Storage Temperature	-65 to 150	°C
T <sub>L</sub>	Lead Temperature, Soldering 10 Seconds	300	°C

Stresses greater than those listed under ABSOLUTE MAXIMUM RATINGS may cause permanent damage to the device. This is a stress rating only and functional operation of the device at these or any other conditions above those indicated in the operational sections of this specification is not implied. Exposure to absolute maximum rating conditions for extended periods may affect reliability.

**RECOMMENDED CONDITIONS**

SYMBOL	PARAMETER	RATING	UNIT
V <sub>KA</sub>	Cathode Voltage	V <sub>REF</sub> to 18	V
I <sub>K</sub>	Cathode Current	10	mA

**TYPICAL THERMAL RESISTANCES**

PACKAGE	θ <sub>JA</sub>	θ <sub>JC</sub>	TYPICAL DERATING
TO-92	160°C/W	80°C/W	6.3mW/°C
SOIC	175°C/W	45°C/W	5.7mW/°C
SOT-23	575°C/W	150°C/W	1.7mW/°C
SOT-89	110°C/W	8°C/W	9.1mW/°C

**FUNCTIONAL BLOCK DIAGRAM**

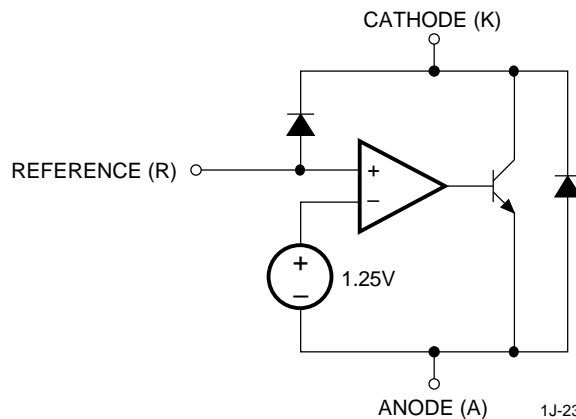

**ELECTRICAL CHARACTERISTICS**

Electrical characteristics are guaranteed over full junction temperature range (0 to 105°C). Ambient temperature must be derated based on power dissipation and package thermal characteristics. The conditions are:  $V_{KA} = V_{REF}$  and  $I_K = 10\text{mA}$  unless otherwise stated.

SYMBOL	PARAMETER	MIN	TYP	MAX	UNIT	TEST CONDITION
$V_{REF}$	Output Voltage	1.244	1.250	1.256	V	$I_K = 10\text{mA}$ , $T_J = 25^\circ\text{C}$ , $V_K = V_{REF}$
$V_{REF}$	Line Regulation		10	15	mV	$V_K = 1.25$ to $15\text{V}$
$V_{REF}$	Load Regulation		3	6	mV	$I_K = 1$ to $100\text{mA}$
$V_{REF}$	Temperature Deviation		2	6	mV	$0 < T_J < 105^\circ\text{C}$
$I_{REF}$	Reference Input Current		3	6	$\mu\text{A}$	
$I_{REF}$	Reference Input Current Temperature Coefficient		0.3	0.6	$\mu\text{A}$	$0 < T_J < 105^\circ\text{C}$
$I_{K(\text{MIN})}$	Min. Cathode Current for Regulation		0.6	1	mA	
$I_{K(\text{MIN})}$	Off State Leakage		0.04	500	nA	$V_{REF} = 0\text{V}$ , $V_{KA} = 18\text{V}$

\*Temperature deviation is defined as the maximum deviation of the reference over the given temperature range and does not imply an incremental deviation at any given temperature.

**TYPICAL PERFORMANCE CURVES** (Not available at time of publishing)

Calogic reserves the right to make changes without further notice to any products described herein to improve reliability, function, or design. Calogic does not assume any liability arising out of the application or use of any product or circuit described herein; neither does it convey any license under its patent rights or the right of others. Calogic products are not authorized for use as components in life support devices or systems intended for surgical implant into the body or intended to support or sustain life. Buyer agrees to notify Calogic of any such intended end use whereupon Calogic will determine availability and suitability of its products for the intended use. Calogic and the Calogic logo are trademarks of Calogic.



TYPICAL PERFORMANCE CURVES

LOW CURRENT OPERATING CHARACTERISTICS

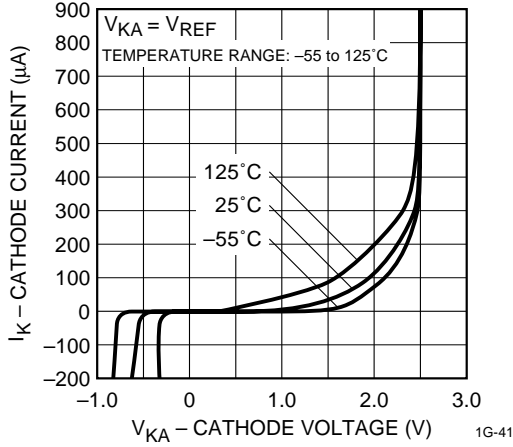

HIGH CURRENT OPERATING CHARACTERISTICS

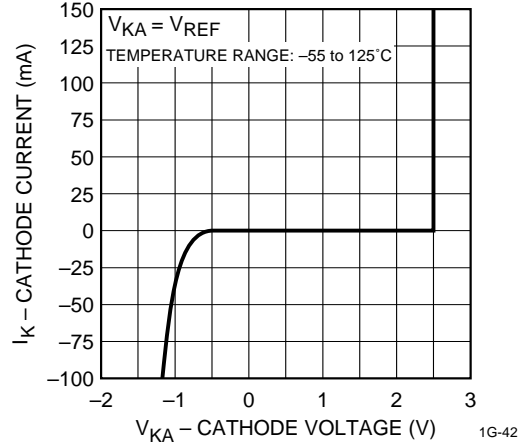

OFF STATE LEAKAGE

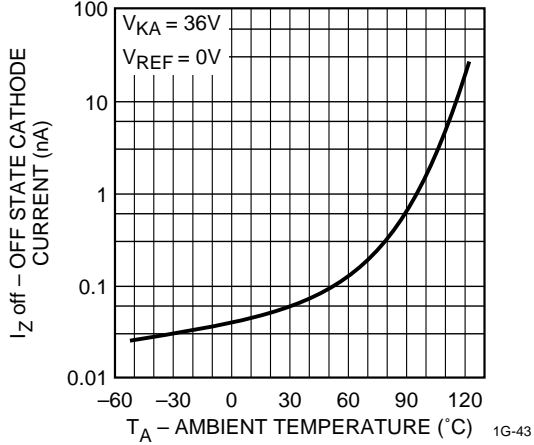

TEMPERATURE COEFFICIENT AS A FUNCTION OF TRIM VALUE

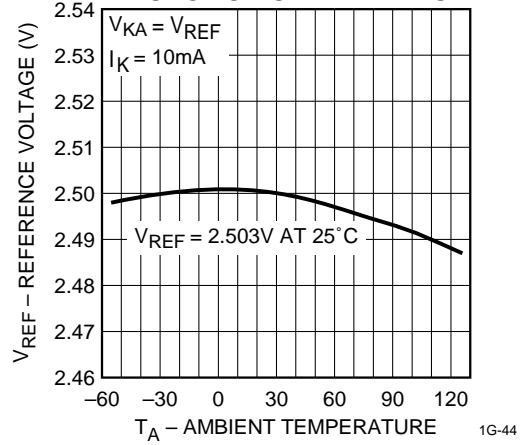

REFERENCE INPUT CURRENT

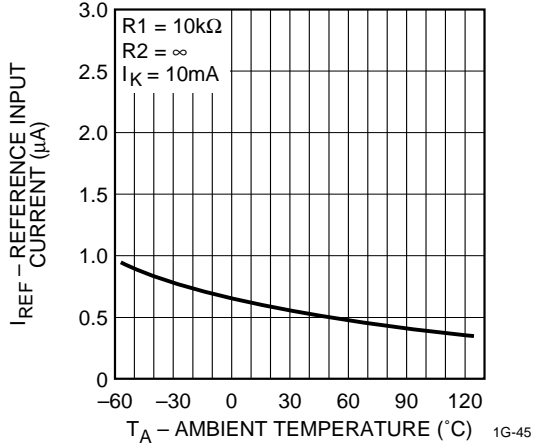

REFERENCE VOLTAGE LINE REGULATION

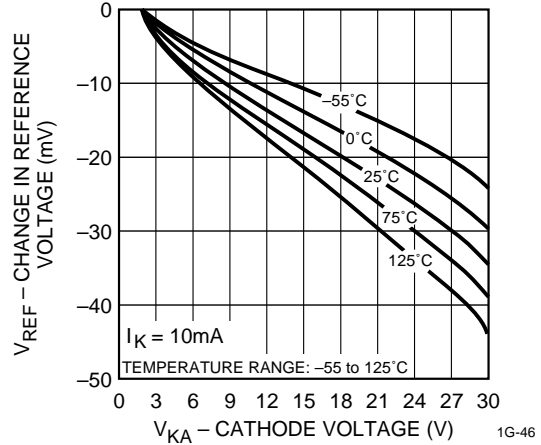

TYPICAL PERFORMANCE CURVES (continued)

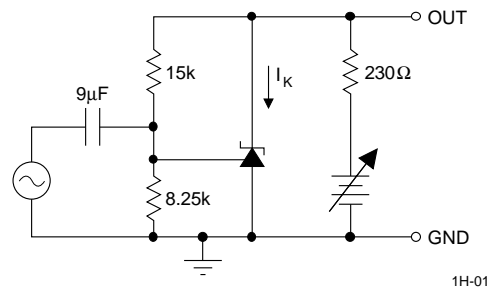
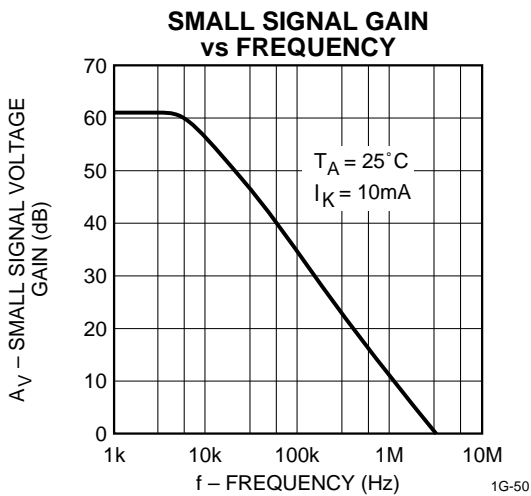
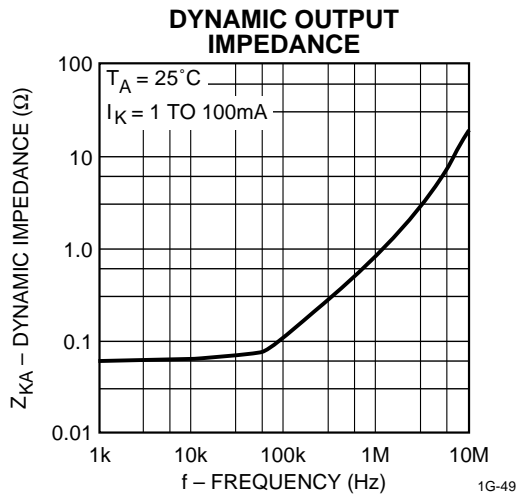
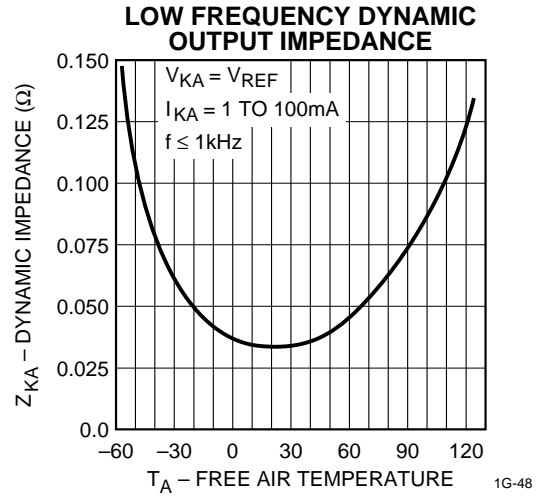
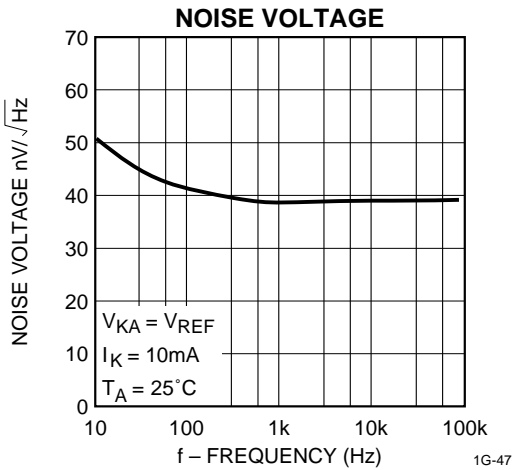

TYPICAL PERFORMANCE CURVES (continued)

