

# CM1452

## LCD & Camera EMI Filter Array with ESD Protection

### Features

- 4, 6 and 8 channels of EMI filtering
- 15kV ESD protection (IEC 61000-4-2, contact discharge)
- 30kV ESD protection (HBM)
- Greater than 30dB of attenuation at 1GHz
- Chip Scale Package (CSP) with 0.40mm pitch and 0.25mm CSP solder ball which features extremely low parasitic inductance for optimum filter and ESD performance
- OptiGuard Coating for improved reliability at assembly
- Lead-free version available

### Applications

- LCD and Camera data lines in mobile handsets
- I/O port protection for mobile handsets, notebook computers, PDAs etc.
- EMI filtering for data ports in cell phones, PDAs or notebook computers.
- Wireless handsets
- Handheld PCs/PDAs
- LCD and camera modules

### General Description

California Micro Devices' CM1452 is a family of pi-style EMI filter arrays with ESD protection, which integrates four, six and eight filters (C-L-C) in CSP form factor with 0.40mm pitch. Each EMI filter channel of the CM1452 is implemented as a 3-pole L-C filter where the component values are 20pF-17nH-20pF. The CM1452's roll-off frequency at -6dB attenuation is 330MHz and can be used in applications where the data rates are as high as 132Mbps while providing greater than 30dB over the 800MHz to 2.7GHz frequency range. The parts include ESD diodes on every I/O pin, which provide a very high level of protection for sensitive electronic components that may be subjected to electrostatic discharge (ESD). The ESD protection diodes connected to the filter ports are designed and characterized to safely dissipate ESD strikes of 15kV, beyond the maximum requirement of the IEC61000-4-2 international standard. Using the MIL-STD-883 (Method 3015) specification for Human Body Model (HBM) ESD, the pins are protected for contact discharges at greater than 30kV.

This device is particularly well suited for wireless handsets, mobile LCD modules and PDAs because of its small package format and easy-to-use pin assignments. In particular, the CM1452 is ideal for EMI filtering and protecting data and control lines for the LCD display and camera interface in mobile handsets.

The CM1452 incorporates OptiGuard which results in improved reliability at assembly. The CM1452 is available in a space saving, low profile Chip Scale Package with optional lead-free finishing (95.5Sn/3.8Ag/0.7Cu). It is manufactured with a 0.40mm pitch and 0.25mm CSP solder ball to provide up to 28% board space savings vs. competing CSP devices with 0.50mm pitch and 0.30mm CSP solder ball.

### Schematic Diagram

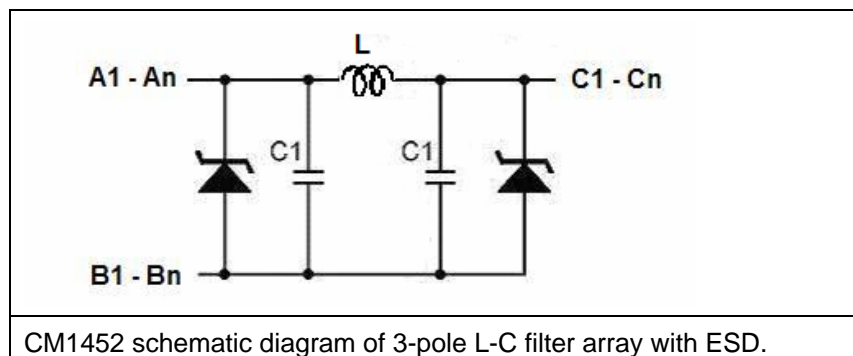

Package Diagrams

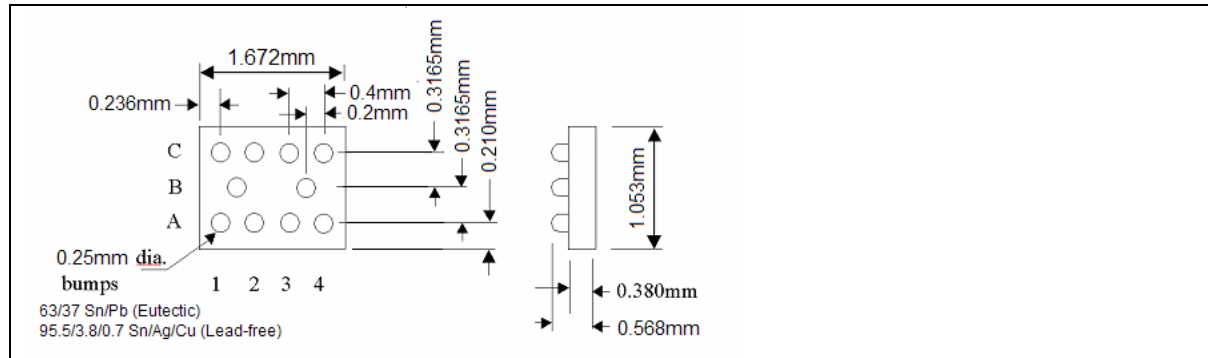

CM1452-04 (4-channel) mechanical diagram.

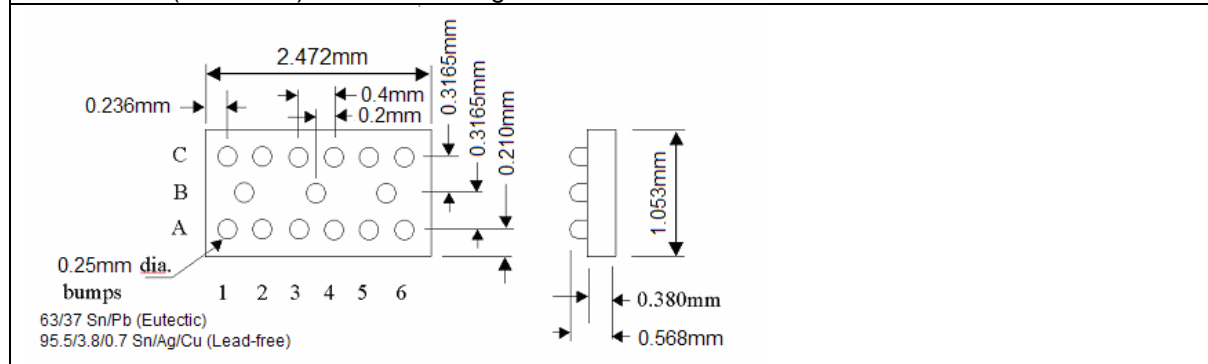

CM1452-06 (6-channel) mechanical diagram.

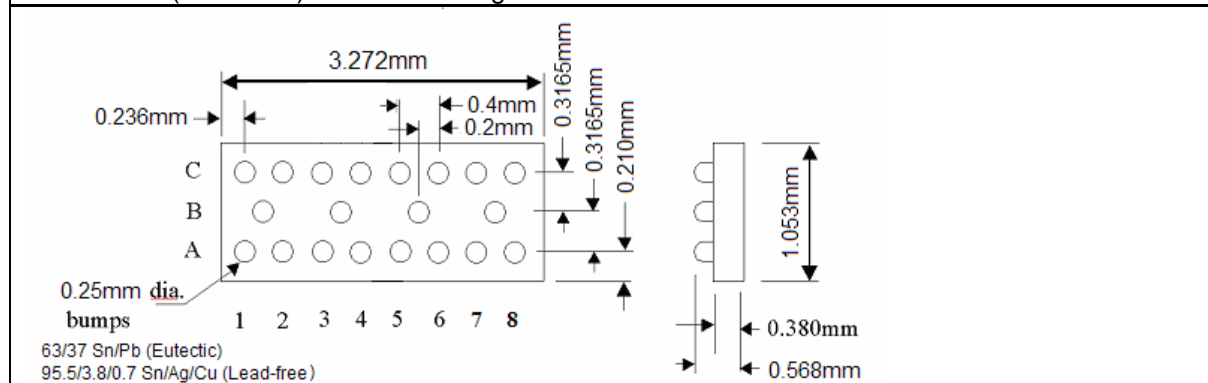

CM1452-08 (8-channel) mechanical diagram.

Pin Number	Pin Description	Pin Number	Pin Description
A1	Filter #1	B3	GND
A2	Filter #2	B4	GND
A3	Filter #3	C1	Filter #1
A4	Filter #4	C2	Filter #2
A5	Filter #5	C3	Filter #3
A6	Filter #6	C4	Filter #4
A7	Filter #7	C5	Filter #5
A8	Filter #8	C6	Filter #6
B1	GND	C7	Filter #7
B2	GND	C8	Filter #8

**Part Ordering Information**

Pins	Package	Lead-free Finish
10	CSP	CM1452-04CP
15	CSP	CM1452-06CP
20	CSP	CM1452-08CP

**Electrical Specifications**

Specifications: (At 25 C unless specified otherwise)	Min.	Typ.	Max.	Unit
Channel Inductance		17		nH
Total Channel Capacitance at 2.5Vdc; 1MHz, 30mVac	32	40	48	pF
Capacitance C1 at 2.5V dc; 1MHz, 30mV ac	16	20	24	pF
Cut-off Frequency, $Z_{SOURCE} = 50$ , $Z_{LOAD} = 50$		148		MHz
Roll-off Frequency at -6dB Attenuation, $Z_{SOURCE} = 50$ , $Z_{LOAD} = 50$		330		MHz
Stand-off Voltage, $I = 10mA$	5.5			V
Diode Leakage at 3.3V reverse bias voltage		0.1	1.0	$\mu A$
Signal Clamp Voltage:				
Positive Clamp, 10mA	5.6	6.8	9.0	V
Negative Clamp, -10mA	-1.5	-0.8	-0.4	V
In-system ESD withstand voltage*:				
Human Body Model (MIL-STD-883, method 3015)	30			kV
IEC 61000-4-2, contact discharge method	15			kV
Dynamic Resistance				
Positive		2.3		
Negative		0.9		
Temperature Range:				
Operating	-40		85	C
Storage	-65		150	
Current per Inductor:			30	mA
DC Package Power Rating:			0.5	W

\* ESD applied to input/output pins with respect to GND, one at a time. Clamping voltage is measured at the opposite side of the EMI filter to the ESD pin (i.e. if ESD is applied to pin A1 then clamping voltage is measured at pin C1). Unused pins are left open. These parameters are guaranteed by design.

**Typical EMI Filter Performance** (0V d.c., 50 environment)

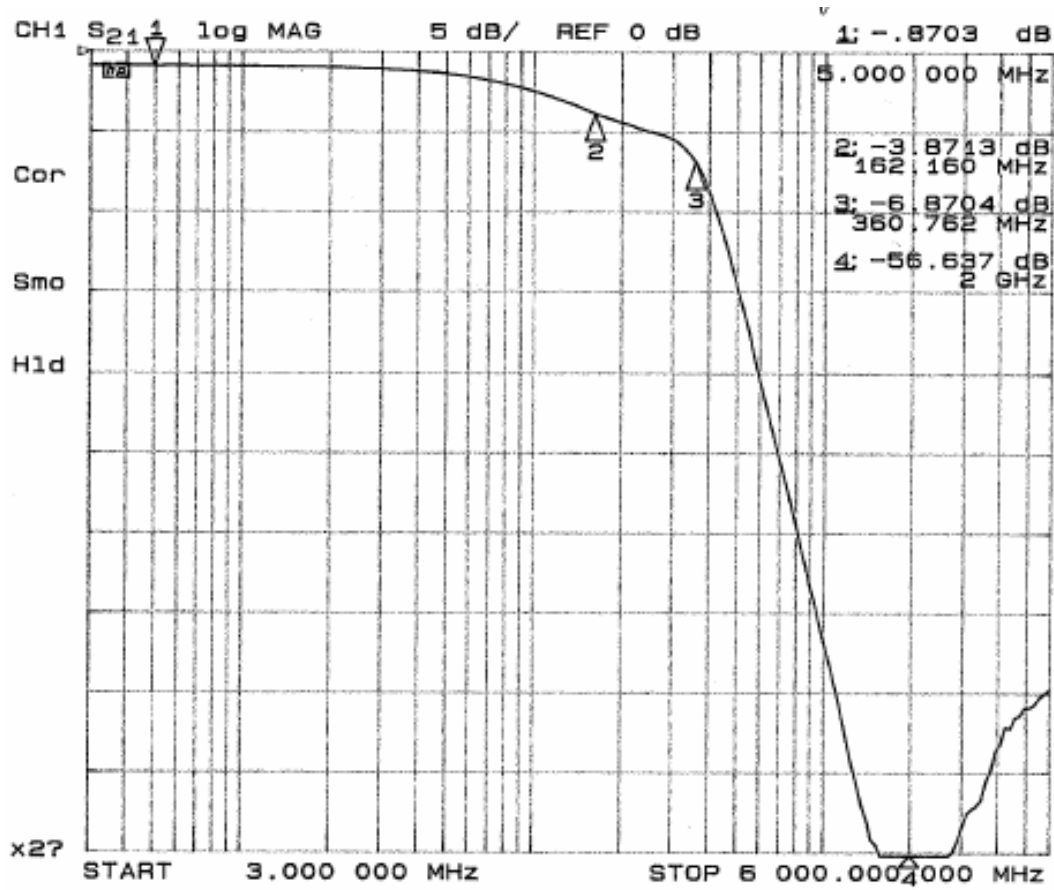

**Typical Diode Capacitance vs. Input Voltage** (normalized to 2.5V d.c.)

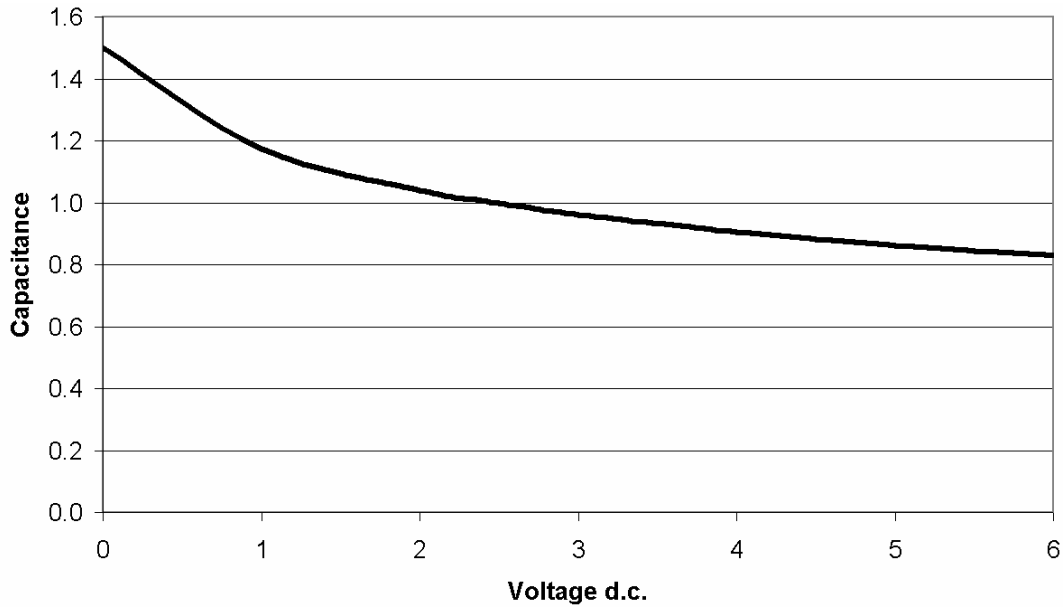

<b>PRINTED CIRCUIT BOARD RECOMMENDATIONS</b>	
Pad size in PCB	0.240mm
Pad Shape	Round
Pad Definition	Non Solder Mask Defined Pads
Solder Mask Opening	0.290mm Round
Solder Stencil Thickness	0.150mm
Solder Stencil Aperture Opening (Laser cut, 5% tapered walls)	0.300mm (round)
Solder Flux Ratio	50/50 by volume
Solder Paste Type	No Clean
Bond Trace Finish	OSP (Entek Cu Plus 106A)
Tolerance – Edge to Corner Ball	50µm
Solder Ball Side Coplanarity	20µm
Soldering Minimum Temperature	205°C for at least 30 seconds
Maximum Dwell Time above Liquidous (183°C)	60 seconds
Soldering Maximum Temperature	260°C for at less than 2 minutes

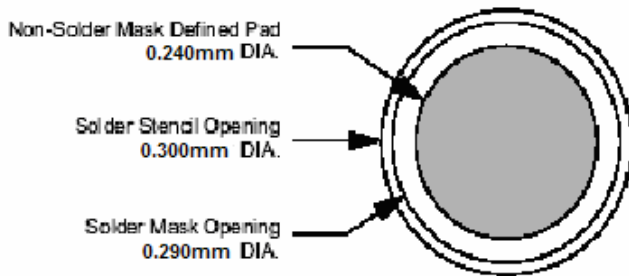

### Solder Reflow Profile

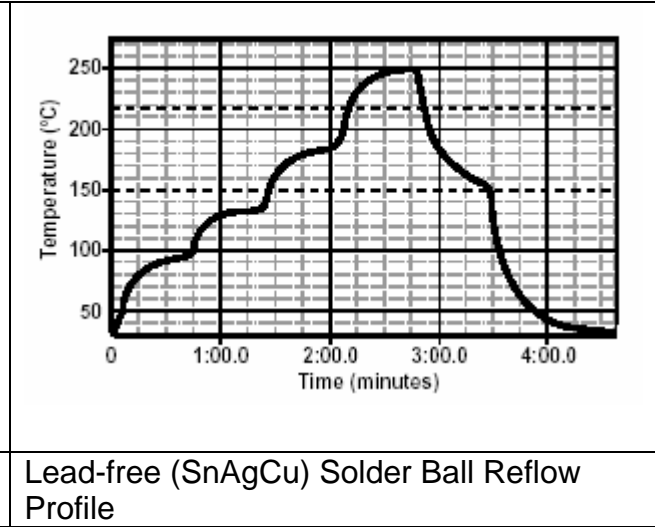
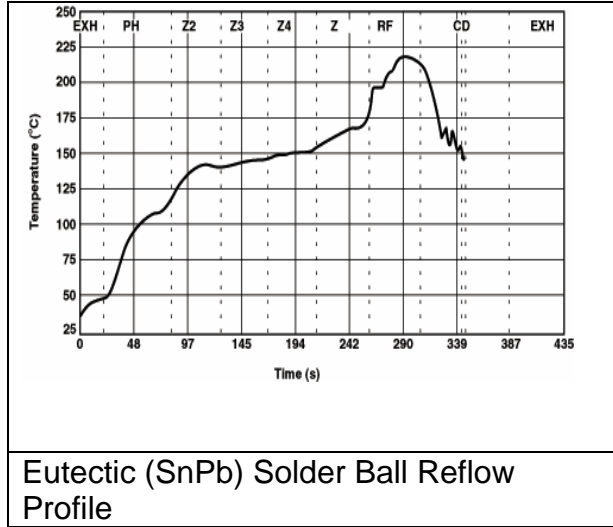

### Tape & Reel Information

CMD PART #	CHIP SIZE (mm)	POCKET SIZE (mm) Bo x Ao x Ko	TAPE WIDTH W	REEL DIAMETER	QTY PER REEL	P <sub>0</sub>	P <sub>1</sub>
CM1452-04CP	1.67 x 1.05 x 0.57		8mm	178mm (7")	3500	4mm	4mm
CM1452-06CP	2.47 x 1.05 x 0.57		8mm	178mm (7")	3500	4mm	4mm
CM1452-08CP	3.30 x 1.05 x 0.57		8mm	178mm (7")	3500	4mm	4mm

