

Dual IGBTMOD™ H-Series Module 50 Amperes/600 Volts

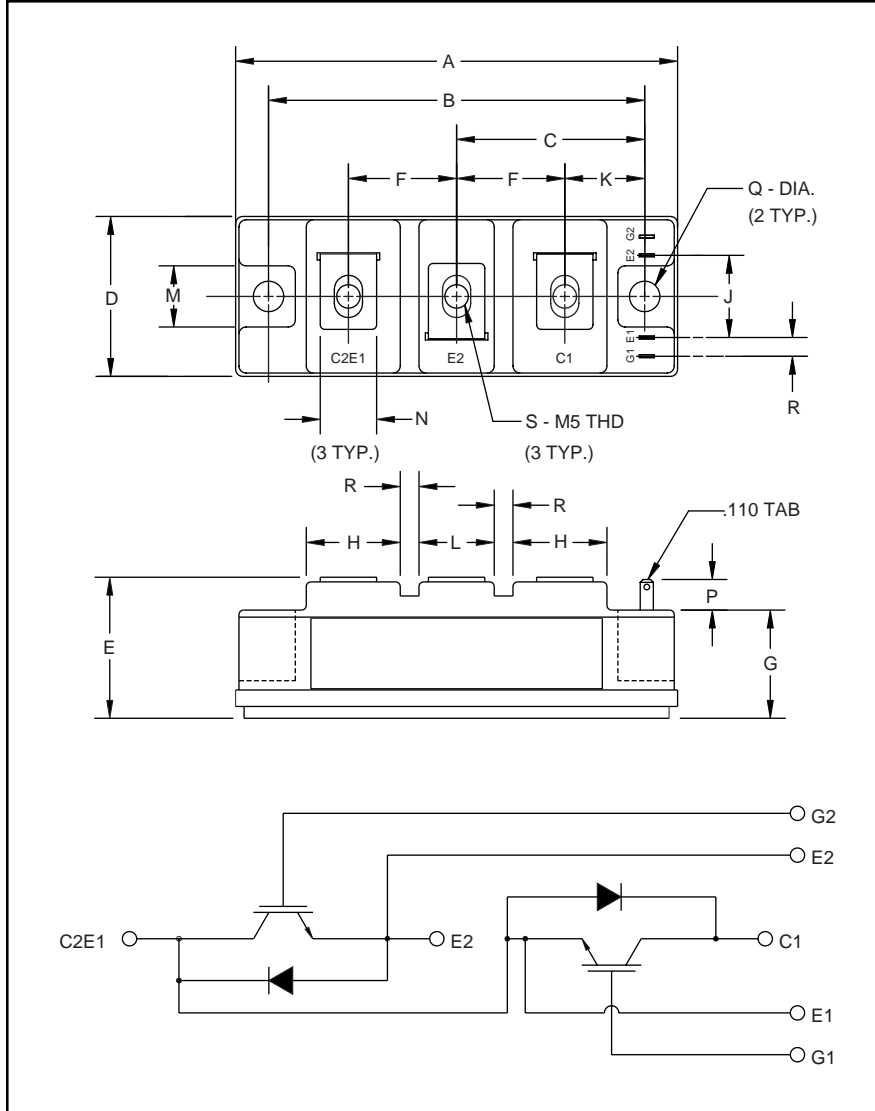

Outline Drawing and Circuit Diagram

Dimensions	Inches	Millimeters
A	3.70	94.0
B	3.150±0.01	80.0±0.25
C	1.57	40.0
D	1.34	34.0
E	1.22 Max.	31.0 Max.
F	0.90	23.0
G	0.85	21.5
H	0.79	20.0
J	0.71	18.0

Dimensions	Inches	Millimeters
K	0.67	17.0
L	0.63	16.0
M	0.51	13.0
N	0.47	12.0
P	0.28	7.0
Q	0.256 Dia.	Dia. 6.5
R	0.16	4.0
S	M5 Metric	M5



Description:

Powerex IGBTMOD™ Modules are designed for use in switching applications. Each module consists of two IGBT transistors in a half-bridge configuration with each transistor having a reverse-connected super-fast recovery free-wheel diode. All components and interconnects are isolated from the heat sinking baseplate, offering simplified system assembly and thermal management.

Features:

- Low Drive Power
- Low $V_{CE(sat)}$
- Discrete Super-Fast Recovery (70ns) Free-Wheel Diode
- High Frequency Operation (20-25kHz)
- Isolated Baseplate for Easy Heat Sinking

Applications:

- AC Motor Control
- Motion/Servo Control
- UPS
- Welding Power Supplies
- Laser Power Supplies

Ordering Information:

Example: Select the complete part module number you desire from the table below -i.e. CM50DY-12H is a 600V (V_{CES}), 50 Ampere Dual IGBTMOD™ Power Module.

Type	Current Rating Amperes	V_{CES} Volts (x 50)
CM	50	12

CM50DY-12H
Dual IGBTMOD™ H-Series Module
 50 Amperes/600 Volts

Absolute Maximum Ratings, $T_j = 25\text{ }^\circ\text{C}$ unless otherwise specified

Ratings	Symbol	CM50DY-12H	Units
Junction Temperature	T_j	-40 to 150	$^\circ\text{C}$
Storage Temperature	T_{stg}	-40 to 125	$^\circ\text{C}$
Collector-Emitter Voltage (G-E SHORT)	V_{CES}	600	Volts
Gate-Emitter Voltage	V_{GES}	± 20	Volts
Collector Current	I_C	50	Amperes
Peak Collector Current	I_{CM}	100*	Amperes
Diode Forward Current	I_F	50	Amperes
Diode Forward Surge Current	I_{FM}	100*	Amperes
Power Dissipation	P_d	250	Watts
Max. Mounting Torque M5 Terminal Screws	-	17	in-lb
Max. Mounting Torque M6 Mounting Screws	-	26	in-lb
Module Weight (Typical)	-	190	Grams
V Isolation	V_{RMS}	2500	Volts

* Pulse width and repetition rate should be such that device junction temperature does not exceed the device rating.

Static Electrical Characteristics, $T_j = 25\text{ }^\circ\text{C}$ unless otherwise specified

Characteristics	Symbol	Test Conditions	Min.	Typ.	Max.	Units
Collector-Cutoff Current	I_{CES}	$V_{CE} = V_{CES}, V_{GE} = 0V$	-	-	1.0	mA
Gate Leakage Current	I_{GES}	$V_{GE} = V_{GES}, V_{CE} = 0V$	-	-	0.5	μA
Gate-Emitter Threshold Voltage	$V_{GE(th)}$	$I_C = 5\text{mA}, V_{CE} = 10V$	4.5	6.0	7.5	Volts
Collector-Emitter Saturation Voltage	$V_{CE(sat)}$	$I_C = 50\text{A}, V_{GE} = 15V$	-	2.1	2.8**	Volts
		$I_C = 50\text{A}, V_{GE} = 15V, T_j = 150^\circ\text{C}$	-	2.15	-	Volts
Total Gate Charge	Q_G	$V_{CC} = 300V, I_C = 50\text{A}, V_{GS} = 15V$	-	150	-	nC
Diode Forward Voltage	V_{FM}	$I_E = 50\text{A}, V_{GS} = 0V$	-	-	2.8	Volts

** Pulse width and repetition rate should be such that device junction temperature rise is negligible.

Dynamic Electrical Characteristics, $T_j = 25\text{ }^\circ\text{C}$ unless otherwise specified

Characteristics	Symbol	Test Conditions	Min.	Typ.	Max.	Units
Input Capacitance	C_{ies}		-	-	5.0	nF
Output Capacitance	C_{oes}	$V_{GE} = 0V, V_{CE} = 10V, f = 1\text{MHz}$	-	-	1.8	nF
Reverse Transfer Capacitance	C_{res}		-	-	1.0	nF
Resistive	Turn-on Delay Time	$t_{d(on)}$	-	-	200	ns
Load	Rise Time	t_r	-	-	300	ns
Switching	Turn-off Delay Time	$t_{d(off)}$	-	-	200	ns
Times	Fall Time	t_f	-	-	300	ns
Diode Reverse Recovery Time	t_{rr}	$I_E = 50\text{A}, di_E/dt = -100\text{A}/\mu\text{s}$	-	-	110	ns
Diode Reverse Recovery Charge	Q_{rr}	$I_E = 50\text{A}, di_E/dt = -100\text{A}/\mu\text{s}$	-	0.14	-	μC

Thermal and Mechanical Characteristics, $T_j = 25\text{ }^\circ\text{C}$ unless otherwise specified

Characteristics	Symbol	Test Conditions	Min.	Typ.	Max.	Units
Thermal Resistance, Junction to Case	$R_{th(j-c)}$	Per IGBT	-	-	0.50	$^\circ\text{C}/\text{W}$
Thermal Resistance, Junction to Case	$R_{th(j-c)}$	Per FWDi	-	-	1.00	$^\circ\text{C}/\text{W}$
Contact Thermal Resistance	$R_{th(c-f)}$	Per Module, Thermal Grease Applied	-	-	0.075	$^\circ\text{C}/\text{W}$

CM50DY-12H
Dual IGBTMOD™ H-Series Module
 50 Amperes/600 Volts

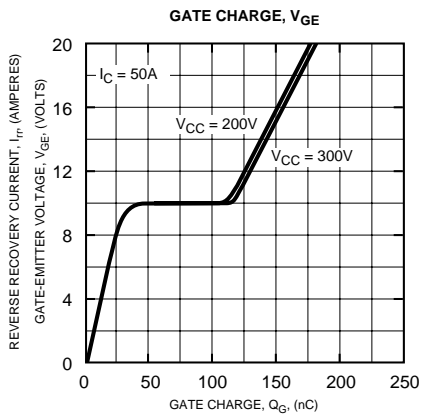
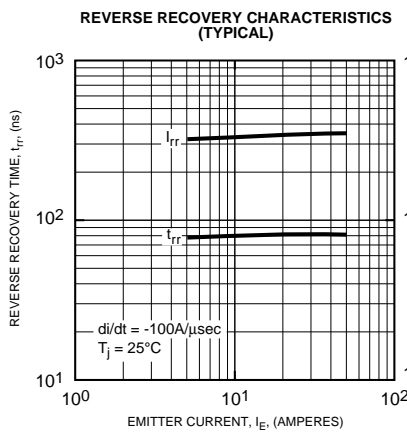
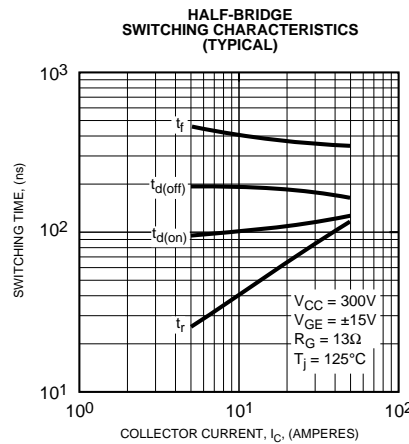
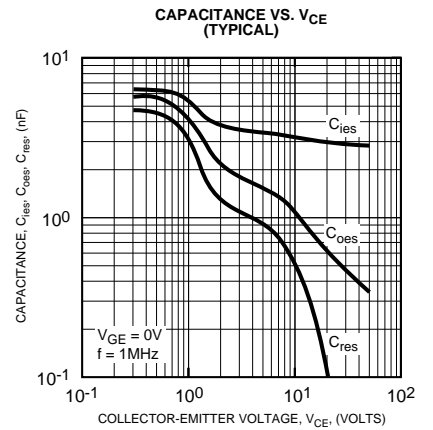
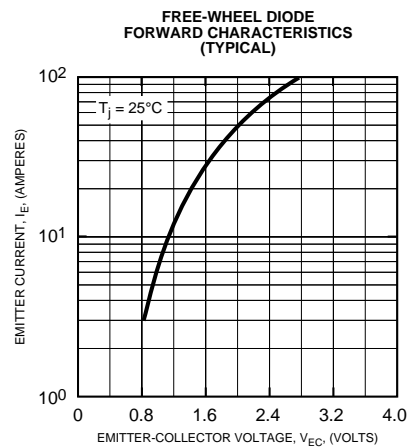
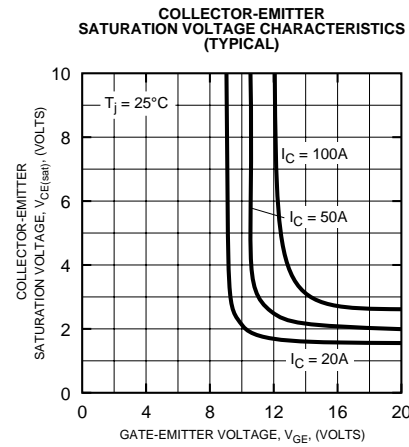
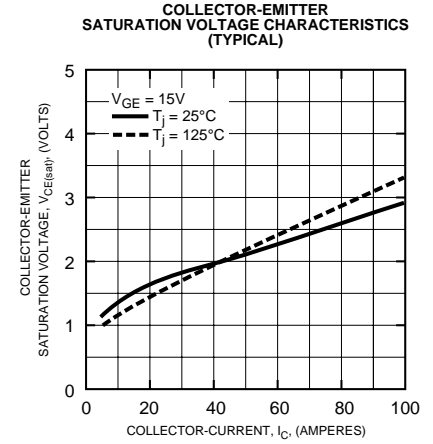
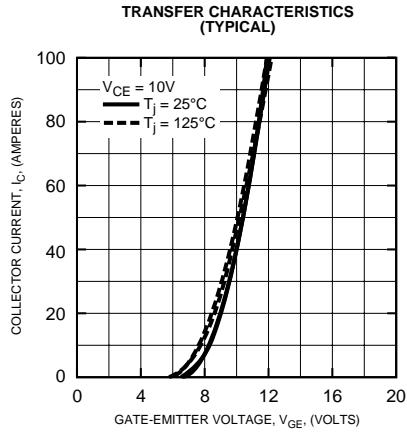
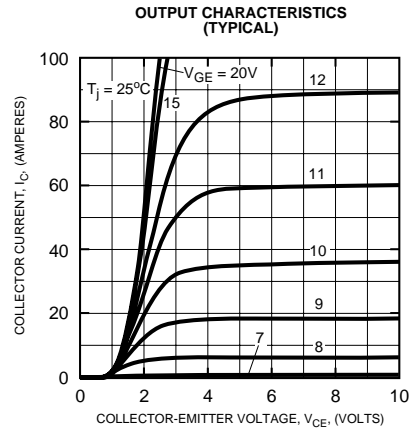

CM50DY-12H
Dual IGBTMOD™ H-Series Module
 50 Amperes/600 Volts

