

Single IGBTMOD™ U-Series Module 600 Amperes/600 Volts

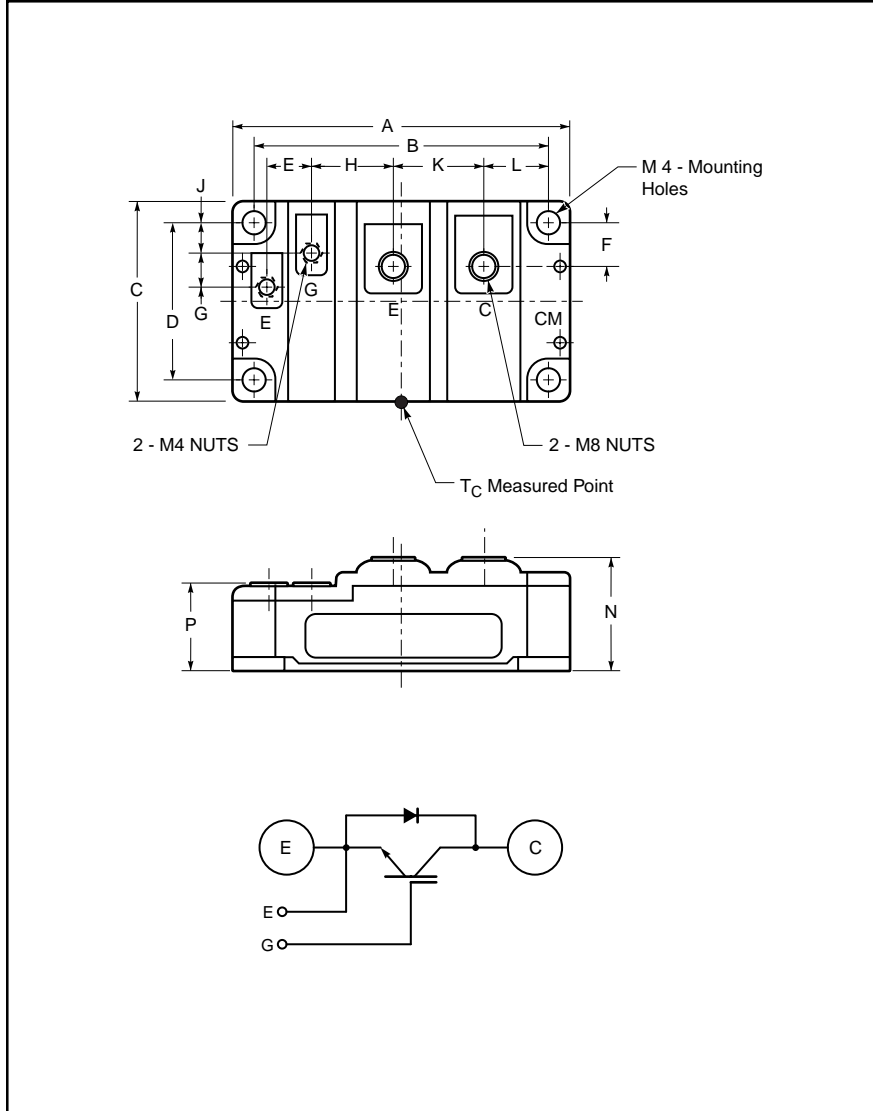

Outline Drawing and Circuit Diagram

| Dimensions | Inches | Millimeters |
|------------|-----------|-------------|
| A | 4.21 | 107.0 |
| B | 3.66±0.01 | 93.0±0.25 |
| C | 2.44 | 62.0 |
| D | 1.89±0.01 | 48.0±0.25 |
| E | 0.53 | 13.5 |
| F | 0.49 | 12.55 |
| G | 0.39 | 10.0 |

| Dimensions | Inches | Millimeters |
|------------|------------------|--------------|
| H | 1.02 | 26.0 |
| J | 0.37 | 9.5 |
| K | 1.14 | 29.0 |
| L | 0.81 | 20.5 |
| M | 0.26 Dia. | 6.5 Dia. |
| N | 1.34 +0.04/-0.02 | 34 +1.0/-0.5 |
| P | 1.02 +0.04/-0.02 | 26 +1.0/-0.5 |



Description:

Powerex IGBTMOD™ Modules are designed for use in switching applications. Each module consists of one IGBT Transistor in a single configuration with a reverse-connected super-fast recovery free-wheel diode. All components and interconnects are isolated from the heat sinking baseplate, offering simplified system assembly and thermal management.

Features:

- Low Drive Power
- Low $V_{CE(sat)}$
- Discrete Super-Fast Recovery Free-Wheel Diode
- Isolated Baseplate for Easy Heat Sinking

Applications:

- AC Motor Control
- Motion/Servo Control
- UPS
- Welding Power Supplies
- Laser Power Supplies

Ordering Information:

Example: Select the complete module number you desire from the table - i.e. CM600HU-12H is a 600V (V_{CES}), 600 Ampere Single IGBTMOD™ Power Module.

| Type | Current Rating Amperes | V_{CES} Volts (x 50) |
|------|------------------------|------------------------|
| CM | 600 | 12 |

CM600HU-12H
Single IGBTMOD™ U-Series Module
 600 Amperes/600 Volts

Absolute Maximum Ratings, $T_j = 25^\circ\text{C}$ unless otherwise specified

| Ratings | Symbol | CM600HU-12H | Units |
|--|------------------|-------------|------------------|
| Junction Temperature | T_j | -40 to 150 | $^\circ\text{C}$ |
| Storage Temperature | T_{stg} | -40 to 125 | $^\circ\text{C}$ |
| Collector-Emitter Voltage (G-E SHORT) | V_{CES} | 600 | Volts |
| Gate-Emitter Voltage (C-E SHORT) | V_{GES} | ± 20 | Volts |
| Collector Current ($T_c = 25^\circ\text{C}$) | I_c | 600 | Amperes |
| Peak Collector Current ($T_j \leq 150^\circ\text{C}$) | I_{CM} | 1200* | Amperes |
| Emitter Current** ($T_c = 25^\circ\text{C}$) | I_E | 600 | Amperes |
| Peak Emitter Current** | I_{EM} | 1200* | Amperes |
| Maximum Collector Dissipation ($T_c = 25^\circ\text{C}$) | P_c | 1560 | Watts |
| Mounting Torque, M8 Main Terminal | – | 95 | in-lb |
| Mounting Torque, M6 Mounting | – | 40 | in-lb |
| Mounting Torque, M4 Terminal | – | 15 | in-lb |
| Weight | – | 450 | Grams |
| Isolation Voltage (Main Terminal to Baseplate, AC 1 min.) | V_{ISO} | 2500 | Volts |

* Pulse width and repetition rate should be such that the device junction temperature (T_j) does not exceed $T_{j(\text{max})}$ rating.

**Represents characteristics of the anti-parallel, emitter-to-collector free-wheel diode (FWDi).

Static Electrical Characteristics, $T_j = 25^\circ\text{C}$ unless otherwise specified

| Characteristics | Symbol | Test Conditions | Min. | Typ. | Max. | Units |
|--------------------------------------|----------------------|--|------|------|------|---------------|
| Collector-Cutoff Current | I_{CES} | $V_{\text{CE}} = V_{\text{CES}}, V_{\text{GE}} = 0\text{V}$ | – | – | 1 | mA |
| Gate Leakage Voltage | I_{GES} | $V_{\text{GE}} = V_{\text{GES}}, V_{\text{CE}} = 0\text{V}$ | – | – | 0.5 | μA |
| Gate-Emitter Threshold Voltage | $V_{\text{GE(th)}}$ | $I_c = 60\text{mA}, V_{\text{CE}} = 10\text{V}$ | 4.5 | 6 | 7.5 | Volts |
| Collector-Emitter Saturation Voltage | $V_{\text{CE(sat)}}$ | $I_c = 600\text{A}, V_{\text{GE}} = 15\text{V}, T_j = 25^\circ\text{C}$ | – | 2.4 | 3.0 | Volts |
| | | $I_c = 600\text{A}, V_{\text{GE}} = 15\text{V}, T_j = 125^\circ\text{C}$ | – | 2.6 | – | Volts |
| Total Gate Charge | Q_G | $V_{\text{CC}} = 300\text{V}, I_c = 600\text{A}, V_{\text{GE}} = 15\text{V}$ | – | 1200 | – | nC |
| Emitter-Collector Voltage* | V_{EC} | $I_E = 600\text{A}, V_{\text{GE}} = 0\text{V}$ | – | – | 2.6 | Volts |

* Pulse width and repetition rate should be such that the device junction temperature (T_j) does not exceed $T_{j(\text{max})}$ rating.

Dynamic Electrical Characteristics, $T_j = 25^\circ\text{C}$ unless otherwise specified

| Characteristics | Symbol | Test Conditions | Min. | Typ. | Max. | Units |
|-------------------------------|---------------------|---|------|------|------|---------------|
| Input Capacitance | C_{ies} | | – | – | 52.8 | nf |
| Output Capacitance | C_{oes} | $V_{\text{CE}} = 10\text{V}, V_{\text{GE}} = 0\text{V}$ | – | – | 28.8 | nf |
| Reverse Transfer Capacitance | C_{res} | | – | – | 7.8 | nf |
| Resistive Load | Turn-on Delay Time | $V_{\text{CC}} = 300\text{V}, I_c = 600\text{A}, V_{\text{GE1}} = V_{\text{GE2}} = 15\text{V}, R_G = 1.0\Omega, \text{Resistive}$ | – | – | 300 | ns |
| | Rise Time | | | | | |
| Switch Times | Turn-off Delay Time | Load Switching Operation | – | – | 350 | ns |
| | Fall Time | | | | | |
| Diode Reverse Recovery Time | t_{rr} | $I_E = 600\text{A}, di_E/dt = -1200\text{A}/\mu\text{s}$ | – | – | 160 | ns |
| Diode Reverse Recovery Charge | Q_{rr} | $I_E = 600\text{A}, di_E/dt = -1200\text{A}/\mu\text{s}$ | – | 1.44 | – | μC |

Thermal and Mechanical Characteristics, $T_j = 25^\circ\text{C}$ unless otherwise specified

| Characteristics | Symbol | Test Conditions | Min. | Typ. | Max. | Units |
|--------------------------------------|-----------------------|------------------------------------|------|------|------|---------------------------|
| Thermal Resistance, Junction to Case | $R_{\text{th(j-c)Q}}$ | Per IGBT Module | – | – | 0.08 | $^\circ\text{C}/\text{W}$ |
| Thermal Resistance, Junction to Case | $R_{\text{th(j-c)D}}$ | Per FWDi Module | – | – | 0.12 | $^\circ\text{C}/\text{W}$ |
| Contact Thermal Resistance | $R_{\text{th(c-f)}}$ | Per Module, Thermal Grease Applied | – | 0.02 | – | $^\circ\text{C}/\text{W}$ |



Powerex, Inc., 200 Hillis Street, Youngwood, Pennsylvania 15697-1800 (724) 925-7272

CM600HU-12H
Single IGBTMOD™ U-Series Module
 600 Amperes/600 Volts

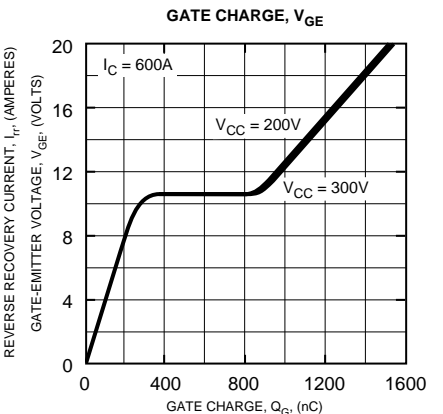
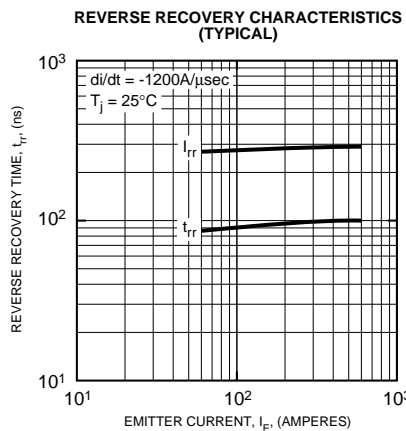
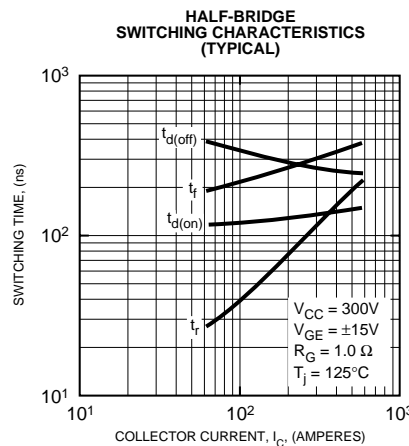
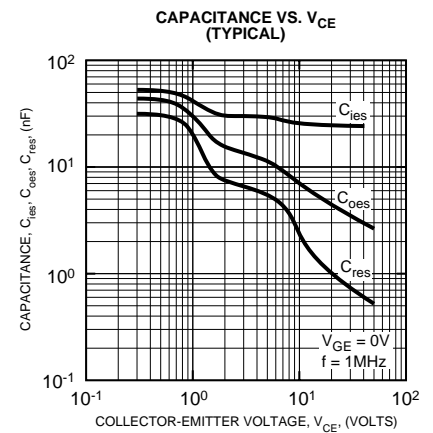
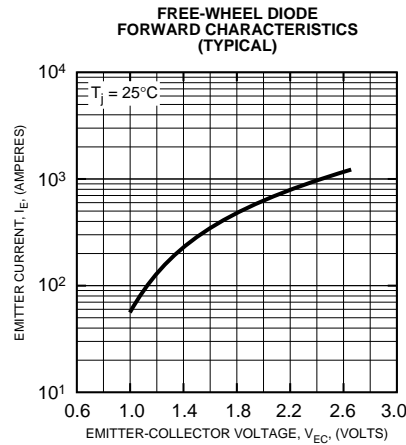
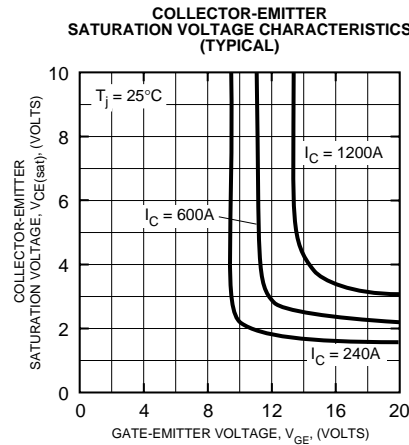
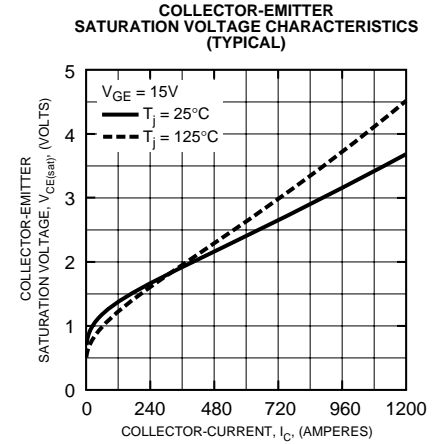
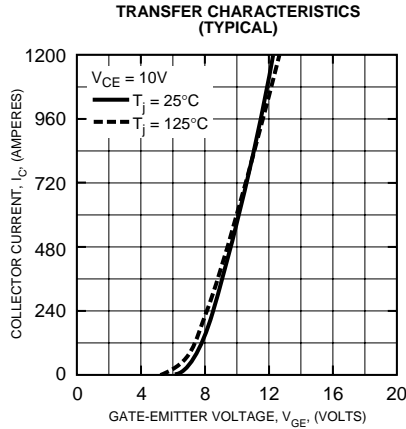
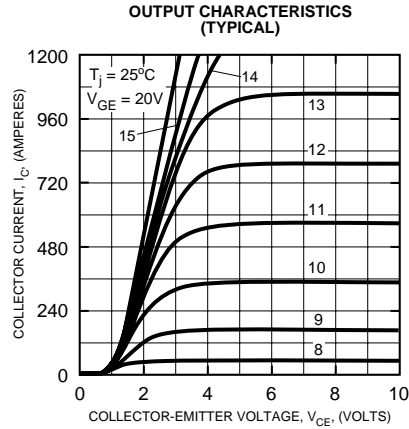

CM600HU-12H
Single IGBTMOD™ U-Series Module
 600 Amperes/600 Volts

