



## Design Example Report

<b>Title</b>	<b><i>24.5W Power Supply using DPA424G</i></b>
<b>Specification</b>	Input: -40 VDC Output: -28V / 480mA, -65 V / 170mA
<b>Application</b>	Telecom Line Card
<b>Author</b>	Power Integrations Applications Department
<b>Document Number</b>	DER-43
<b>Date</b>	November 18, 2004
<b>Revision</b>	1.0

### Summary and Features

- Very high efficiency (>92 % at full load)
- Built-in input under-voltage lockout
- Single converter for both generating dual output voltages
- Non-isolated design
- Compact design
- Transistor feedback signal (instead of opto-coupler)
- Low component count

The products and applications illustrated herein (including circuits external to the products and transformer construction) may be covered by one or more U.S. and foreign patents or potentially by pending U.S. and foreign patent applications assigned to Power Integrations. A complete list of Power Integrations' patents may be found at [www.powerint.com](http://www.powerint.com).

## Table Of Contents

1	Introduction .....	3
2	Power Supply Specification .....	4
3	Schematic .....	5
4	Circuit Operation .....	6
4.1	General .....	6
4.2	Description .....	6
5	BOM .....	7
6	Layout .....	8
7	Transformer Design Spreadsheet .....	9
8	Transformer Specification .....	11
8.1	Transformer Winding .....	11
8.2	Electrical Specifications .....	11
8.3	Materials .....	11
8.4	Transformer Build Diagram .....	12
8.5	Transformer Construction .....	12
9	Efficiency .....	13
10	Regulation vs. Load .....	14
11	Low Load Power Consumption .....	15
12	Drain Voltage and Current Waveforms .....	16
13	Transient Load .....	17
13.1	Transient Load Test Setup .....	17
13.2	Transient Load Performance .....	18
14	Output Ripple .....	19
14.1	Output Ripple Measurement Technique .....	19
14.2	Full Load Ripple Performance .....	20
14.3	No Load Ripple Performance .....	20
15	Other results .....	21
16	Revision History .....	22

### Important Note:

This board is designed to be non-isolated. Please take necessary safety precautions.

Design Reports contain a power supply design specification, schematic, bill of materials, and transformer documentation. Performance data and typical operation characteristics are included. Typically only a single prototype has been built.



## 1 Introduction

This document is an engineering report describing a prototype power supply used on the line cards of a PABX phone system, utilizing DPA424G. The power supply delivers 24.5 W continuous from a -40 VDC input. The power supply uses transistor based non-isolated feedback instead of an opto-coupler (opto-couplers are not permitted for some telecom supplies).

This document provides complete design information including specification, schematic, bill of material and transformer design and construction information. The document also provides performance information.

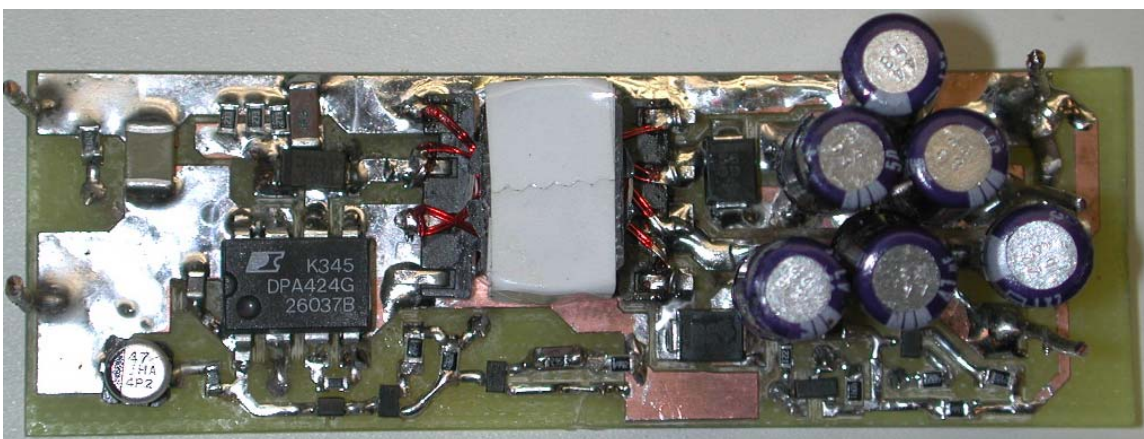

Figure 1 – Top view of board

## 2 Power Supply Specification

Description	Symbol	Min	Typ	Max	Units	Comment
<b>Input</b>						
Voltage	$V_{IN}$	32.	40	48	VDC	
Under-Voltage	$V_{IN\_UV}$			32.7	VDC	Power supply should not operate below this input voltage.
Over-Voltage	$V_{IN\_OV}$		N/A		VDC	Power supply should not operate above this input voltage.
<b>Output</b>						
Output Voltage 1	$V_{OUT1}$	-26.6	-28	-29.4	V	± 5%
Output Ripple Voltage 1	$V_{RIPPLE1}$			280	mVp-p	20 MHz bandwidth
Output Current 1	$I_{OUT1}$	10		480	mA	
Output Voltage 2	$V_{OUT2}$	-61.75	-65	-68.25	V	± 5%
Output Ripple Voltage 2	$V_{RIPPLE2}$			650	mVp-p	20 MHz bandwidth
Output Current 2	$I_{OUT2}$	1		170	mA	
<b>Total Output Power</b>						
Average Output Power	$P_{OUT1}$		13.44		W	
Average Output Power	$P_{OUT2}$		11.05		W	
Average Output Power	$P_{OUT\_TOTAL}$		24.5		W	
Average Output Power	$P_{OUT\_FAULT}$			100	W	
<b>Full Load Efficiency</b>	$\eta$	77	92		%	
<b>Environmental</b>						
Conducted EMI						Meets CISPR22B / EN55022B
Safety						Designed to meet IEC950, UL1950 Class II
Ambient Temperature	$T_{AMB}$	0		40	°C	Forced airflow



### 3 Schematic

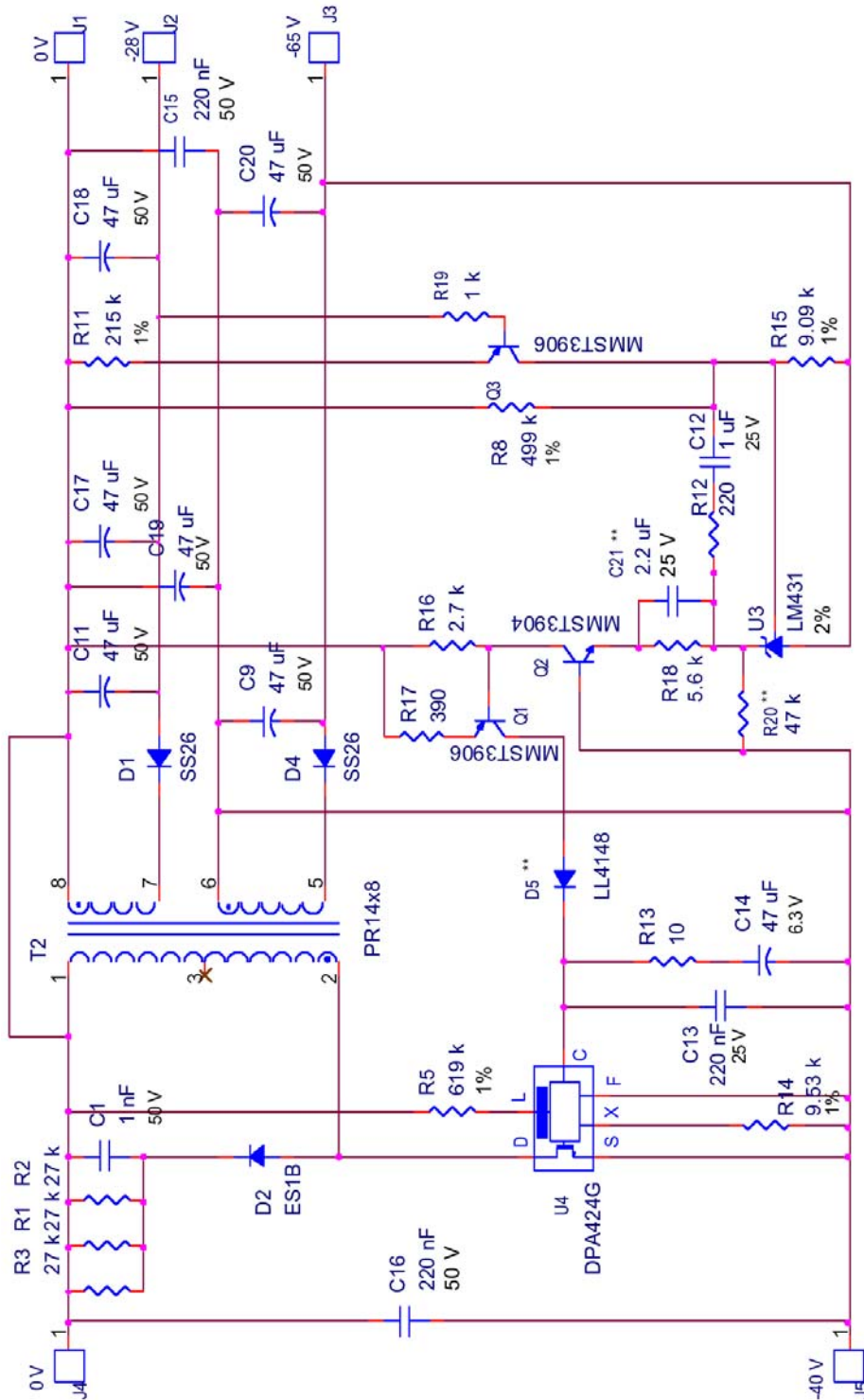

\*\* DENOTES PARTS ADDED AFTER THE PCB-BOARD LAYOUT WAS COMPLETE. FOR THESE PARTS THERE WILL BE NO POSITION SHOWN ON THE LAYOUT IMAGE.

Figure 2 –Schematic



## 4 Circuit Operation

### 4.1 General

The power supply uses a DPA424 device (U4), with integrated MOSFET and controller, in a non-isolated flyback configuration. The circuit also uses the under-voltage shutdown feature of the device.

### 4.2 Description

The input is decoupled by capacitor (C16). The DPA-Switch (U4) provides the PWM, controller and main switching MOSFET for this flyback supply. Resistor R5 programs the under-voltage shutdown of the DPA-Switch (U4). Startup will occur at voltages between 32.9 V (min) and 38.7 V (max). Resistor R14 programs the current limit of the DPA-Switch. Capacitors C13 and C14 provide device decoupling with C14 also program the startup and autorestart period of the device. Resistor R13 provides feedback compensation in conjunction with C14. Components D2, C1, R1, R2 and R3 form an RCD clamp circuit to limit the leakage inductance voltage spikes at primary turn-off. The inductance of transformer T2 provides the energy storage and conversion component of the circuit. The winding for the -28 V output is connected to the 0V input rail and thus is non-isolated but the transformer does provide functional isolation (not safety isolation) for the winding generating the -65 V output, generated from the -40 V DC input rail.

The -28 V output is rectified and filtered by diode D1 and capacitors C11, C17 and C18. The -65 V output is rectified and filtered by diode D4 and capacitors C9 and C20 (*note: - the output capacitors used on the prototype are through-hole aluminum-electrolytic capacitors but are intended to be replaced with SMD aluminum-electrolytic capacitors, that were not available in time for the construction of this prototype*). In this power supply the input rails are used as references to generate the output voltages, as such we need to make sure that there is not primary side switching ripple on the 0 V and -40 V rails. This is achieved using additional decoupling capacitors C19 and C15. Without these two capacitors, all the ripple generated by primary switching, would also be superimposed on the output voltages. Resistor R8 senses the -65 V output voltage and components R11, Q3 and R19 form an inverting follower to provide sense of the -28 V output voltage. Both of these sense signals are summed and generate a voltage on resistor R15, which controls the LM431 (U3). Components R12 and C12 provide compensation for U3, to make sure that it's frequency response is limited only to low-frequency signals. Resistor R20 provides bias current to U3 (from the -40 V rail). Components R18, Q2, R16 provide level shifting to transmit the feedback signal. Capacitor C21 increase the high frequency response of the loop. Components R17, Q1 provide the final connection of the to the CONTROL pin of U4, with diode D5 preventing reverse biasing of the Q1 collector-base junction when the base is below CONTROL pin potential (which happens at startup). Resistor R17 in conjunction with R16 and R18 program the DC gain of the loop.



## 5 BOM

Item	Qty.	Ref.	Description	Mfg Part Number	Mfg
1	1	C1	1 nF, 50 V, Ceramic, X7R, 0805	ECJ-2VB1H102K	Panasonic
2	6	C9 C11 C17 C18 C19 C20	47 uF, 50 V, Electrolytic, Low ESR, 450 mOhm, (6.3 x 11.5)	LXZ50VB47RMF11LL	United Chemi-Con
3	1	C12	1 uF, 25 V, Ceramic, X7R, 1206	ECJ-3YB1E105K	Panasonic
4	1	C13	220 nF, 25 V, Ceramic, X7R, 0805	ECJ-2YB1E224K	Panasonic
5	1	C14	47 uF, 6.3 V, Electrolytic, (4 x 5.4), SMD	EEVHA0L470WR	Panasonic
6	2	C15 C16	220 nF, 50 V, Ceramic, X7R, 1206	ECJ-3YB1H224K	Panasonic
7	1	C21	2.2 uF, 25 V, Ceramic, X7R, 1206	ECJ-3YB1E225K	Panasonic
8	2	D1 D4	60 V, 2 A, Schottky, DO-214AA	SS26	Vishay
9	1	D2	100 V, 1 A, Ultrafast Recovery, 25 ns, DO-214AC	ES1B	Vishay
10	1	D5	75 V, 0.15 A, Fast Switching, 4 ns, MELF	LL4148	Diode Inc.
11	5	J1 J2 J3 J4 J5	PCB Terminal Hole, 22 AWG	N/A	N/A
12	2	Q1 Q3	PNP, Small Signal BJT, 40 V, 0.2 A, SOT-323	MMST3906-7	Diodes Inc
13	1	Q2	NPN, Small Signal BJT, 40 V, 0.2 A, SOT-323	MMST3904	Diodes Inc
14	3	R1 R2 R3	27 k, 5%, 1/8 W, Metal Film, 0805	ERJ-6GEYJ273V	Panasonic
15	1	R5	619 k, 1%, 1/8 W, Metal Film, 0805	ERJ-6ENF6193V	Panasonic
16	1	R8	499 k, 1%, 1/8 W, Metal Film, 0805	ERJ-6ENF4993V	Panasonic
17	1	R11	215 k, 1%, 1/8 W, Metal Film, 0805	ERJ-6ENF2153V	Panasonic
18	1	R12	220 R, 5%, 1/10 W, Metal Film, 0603	ERJ-3GEYJ221V	Panasonic
19	1	R13	10 R, 5%, 1/10 W, Metal Film, 0603	ERJ-3GEYJ100V	Panasonic
20	1	R14	9.53 k, 1%, 1/16 W, Metal Film, 0603	ERJ-3EKF9531V	Panasonic
21	1	R15	9.09 k, 1%, 1/16 W, Metal Film, 0603	ERJ-3EKF9091V	Panasonic
22	1	R16	2.7 k, 5%, 1/8 W, Metal Film, 0805	ERJ-6GEYJ272V	Panasonic
23	1	R17	390 R, 5%, 1/8 W, Metal Film, 0805	ERJ-6GEYJ391V	Panasonic
24	1	R18	5.6 k, 5%, 1/8 W, Metal Film, 0805	ERJ-6GEYJ562V	Panasonic
25	1	R19	1 k, 5%, 1/10 W, Metal Film, 0603	ERJ-3GEYJ102V	Panasonic
26	1	R20	47 k, 5%, 1/8 W, Metal Film, 0805	ERJ-6GEYJ473V	Panasonic
27	1	T2	Bobbin, PR14x8, Horizontal, 10 pins, SMD	S-1403	Pin Shine
28	1	U3	2.495 V Shunt Regulator IC, 2%, -40 to 85C, SOT23	LM431AIM	National Semiconductor
29	1	U4	DPA-Switch, DPA424G, DIP-8B	DPA424G	Power Integrations
	<b>43</b>		<b>TOTAL COMPONENTS</b>		







## 7 Transformer Design Spreadsheet

Flyback_013004_Revision1J. Copyright Power Integrations 2004					
INPUT	INFO	OUTPUT	UNITS	DPASwitch_Flyback_013004 - Continuous/Discontinuous mode Spreadsheet.	
<b>ENTER APPLICATION VARIABLES</b>					
VDCMIN	36		Volts	Minimum DC Input Voltage	
VDCMAX	48		Volts	Maximum DC Input Voltage	
VO	28		Volts	Output Voltage	
PO	17.7		Watts	Output Power	
n	0.8			Efficiency Estimate	
Z		0.7		Loss Allocation Factor, (0.7 Recommended)	
VB	14		Volts	Bias Voltage (Recommended between 12V and 18V)	
<b>UV AND OV PARAMETERS</b>					
		min	max		
VUVOFF	30.05	30.05	33.14551	Volts	Minimum undervoltage On-Off threshold
VUVON		32.21685	34.69326	Volts	Maximum undervoltage Off-On threshold (turn-on)
VOVON		74.93483	-	Volts	Minimum overvoltage Off-On threshold
VOVOFF			94.74607	Volts	Maximum overvoltage On-Off threshold (turn-off)
RL			619.1011	k-Ohms	
<b>ENTER DPASWITCH VARIABLES</b>					
DPASWITCH	dpa424			16VDC	36VDC
Chosen Device	#N/A		Power Out	11W	26W
ILIMITMAX	#N/A	2.68		Amps	From DPASWITCH Data Sheet
Frequency	F				Enter 'F' for fS = 400KHz and 'L' for fS = 300KHz
fS	#N/A			Hertz	DPASWITCH Switching Frequency
VOR	50		50	Volts	Reflected Output Voltage
KI	0.80		0.8		Current Limit Reduction Factor
ILIMITEXT			1.856	Amps	Minimum External Current limit
RX			9.501216	k-Ohms	Resistor from X pin to source to set external current limit
VDS	1			Volts	DPASWITCH on-state Drain to Source Voltage
VD	0.5			Volts	Output Winding Diode Forward Voltage Drop
VDB	0.7			Volts	Bias Winding Diode Forward Voltage Drop
KRP/KDP	0.62				Ripple to Peak Current Ratio (0.2 < KRP < 1.0 : 1.0 < KDP < 6.0)
<b>ENTER TRANSFORMER CORE/CONSTRUCTION VARIABLES</b>					
Core Type	pr14x8				
Core Manuf					
Bobbin Manuf					
Core		PR14x8		P/N:	B65755-J-R87
Bobbin		PR14x8	Bobbin	P/N:	B65542-B-T1
AE			0.253	cm^2	Core Effective Cross Sectional Area
LE			2.53	cm	Core Effective Path Length
AL			2000	nH/T^2	Ungapped Core Effective Inductance
BW			4.4	mm	Bobbin Physical Winding Width
M	0			mm	Safety Margin Width (Half the Primary to Secondary Creepage Distance)
L	2				Number of Primary Layers
NS	9				Number of Secondary Turns



<b>CURRENT WAVEFORM SHAPE PARAMETERS</b>				
<b>DMAX</b>			0.588235	Maximum Duty Cycle
<b>I AVG</b>			0.614583	Amps Average Primary Current
<b>IP</b>			1.514191	Amps Peak Primary Current
<b>IR</b>			0.938798	Amps Primary Ripple Current
<b>IRMS</b>			0.827837	Amps Primary RMS Current
<b>TRANSFORMER PRIMARY DESIGN PARAMETERS</b>				
<b>LP</b>			56.54287	uHenries Primary Inductance
<b>NP</b>			15.78947	Primary Winding Number of Turns
<b>NB</b>			4.642105	Bias Winding Number of Turns
<b>ALG</b>			226.7997	nH/T^2 Gapped Core Effective Inductance
<b>BP</b>			2627.046	Gauss Peak Flux density during transients (Limit to 3000 Gauss)
<b>BM</b>			2143.238	Gauss Maximum Flux Density
<b>BAC</b>			664.4036	Gauss AC Flux Density for Core Loss Curves (0.5 X Peak to Peak)
<b>ur</b>			1591.546	Relative Permeability of Ungapped Core
<b>LG</b>			0.124284	mm Gap Length (Lg >> 0.051 mm)
<b>BWE</b>			8.8	mm Effective Bobbin Width
<b>TRANSFORMER SECONDARY DESIGN PARAMETER</b>				
<b>ISP</b>			2.656475	Amps Peak Secondary Current
<b>ISRMS</b>			1.21512	Amps Secondary RMS Current
<b>IO</b>			0.632143	Amps Power Supply Output Current
<b>IRIPPLE</b>			1.037744	Amps Output Capacitor RMS Ripple Current
<b>VOLTAGE STRESS PARAMETERS</b>				
<b>VDRAIN</b>			173	Volts Maximum Drain Voltage (Includes Effect of Leakage Inductance)
<b>PIVS</b>			55.36	Volts Output Rectifier Maximum Peak Inverse Voltage
<b>PIVB</b>			28.112	Volts Bias Rectifier Maximum Peak Inverse Voltage
<b>ADDITIONAL OUTPUTS</b>				
<b>V_OUT2</b>	28.0000			Volts Auxiliary Output Voltage
<b>VD_OUT2</b>	0.5000			Volts Auxiliary Diode Forward Voltage Drop
<b>N_OUT2</b>			9	Auxiliary Number of Turns
<b>PIV_OUT2</b>			55.36	Volts Auxiliary Rectifier Maximum Peak Inverse Voltage
<b>V_OUT3</b>	25			Volts Auxiliary Output Voltage
<b>VD_OUT3</b>	0.5			Volts Auxiliary Diode Forward Voltage Drop
<b>N_OUT3</b>			8.052632	Auxiliary Number of Turns
<b>PIV_OUT3</b>			49.48	Volts Auxiliary Rectifier Maximum Peak Inverse Voltage

Note1: the PO value in this spreadsheet is 17.7 W. The power supply provides -28 V at 480 mA and -65 V at 170 mA which would give a total of 24.5 W. However the -65 V output is derived from the -40 VDC input, thus the switched-mode converter only provides the remaining -25V at 170 mA, saving (-40 V x 170 mA = 6.8 W) to give a total converted power of 17.7 W.

Note2: the second output (shown as VOUT3) has a voltage of - 25 V. This is the output that combined with -40 VDC gives -65 V output.



## 8 Transformer Specification

### 8.1 Transformer Winding

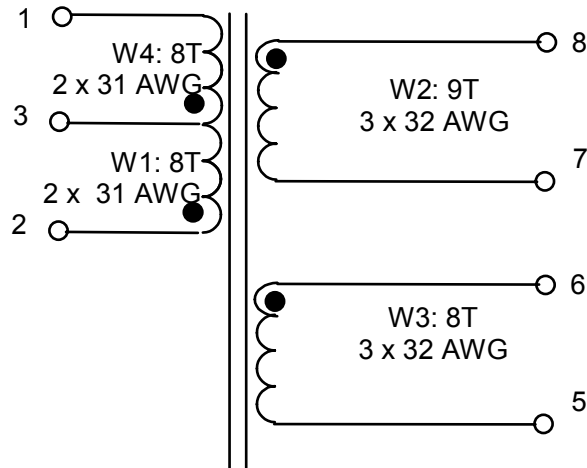

Figure 4 –Transformer Electrical Diagram

### 8.2 Electrical Specifications

<b>Electrical Strength</b>	Non-isolated	N/A
<b>Primary Inductance</b>	Pins 1-2, all other windings open, measured at 400 kHz, 0.4 VRMS	57 $\mu$ H, -0/+20%
<b>Resonant Frequency</b>	Pins 1-2, all other windings open	5 MHz (Min.)
<b>Primary Leakage Inductance</b>	Pins 1-2, with Pins 5,6,7,8 shorted, measured at 400 kHz, 0.4 VRMS	500 nH (Max.)

### 8.3 Materials

Item	Description
[1]	Core: PR14x8 ALG=227 nH/t <sup>2</sup>
[2]	Bobbin: PR14x8 8-pin vertical
[3a]	31AWG Doubled insulated
[3b]	32 AWG Doubled insulated
[6]	Tape:
[8]	Varnish

## 8.4 Transformer Build Diagram

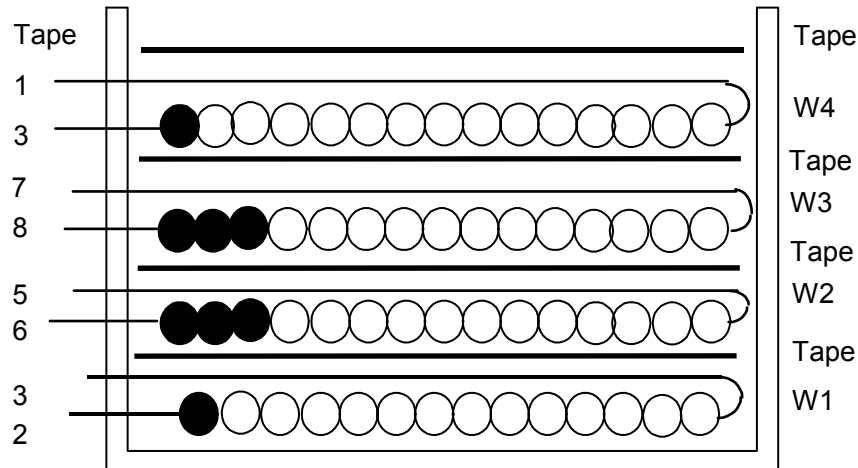

Figure 5 – Transformer Build Diagram.

## 8.5 Transformer Construction

<b>W1</b>	Start at Pin 2. Wind 8 turns bifilar item [3a]. Finish on pin 3
<b>Tape</b>	Use layer of item [6].
<b>W2</b>	Start at Pin 6. Wind 9 turns trifilar item [3b]. Finish on pin 5
<b>Tape</b>	Use layer of item [6].
<b>W3</b>	Start at Pins 7. Wind 8 turns trifilar item [3b]. Finish on pin 8
<b>Tape</b>	Use layer of item [6].
<b>W4</b>	Start at Pin 3. Wind 8 turns bifilar item [3a]. Finish on pin 1.
<b>Other</b>	When using PC-board (App140512_Brd_082704A-3), remove pin 3 PC-board solder tab, to prevent shorting on the PC-board. This corrects an error on the PC-board.
<b>Outer Wrap</b>	Wrap windings with 3 layers of tape [item [7].
<b>Final Assembly</b>	Assemble and secure core halves. Varnish impregnate (item [8]).

## 9 Efficiency

### Efficiency vs Line/Load

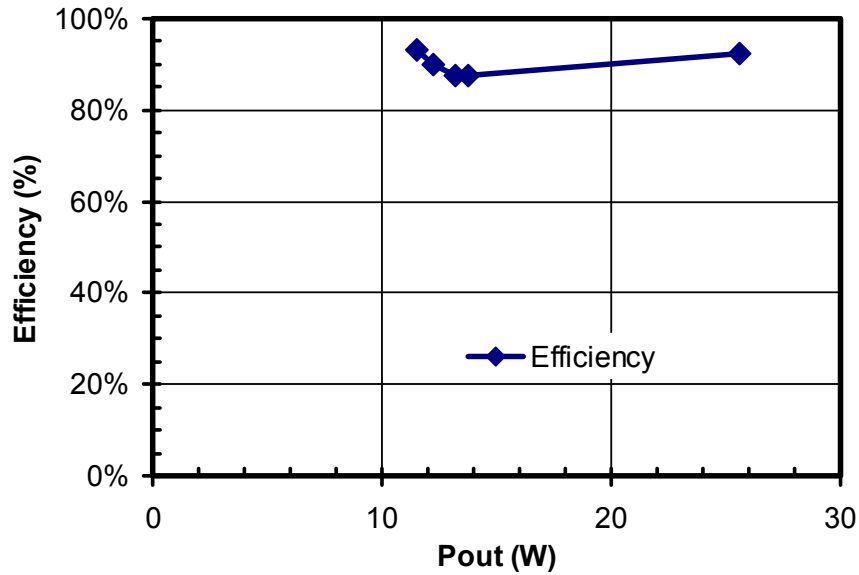
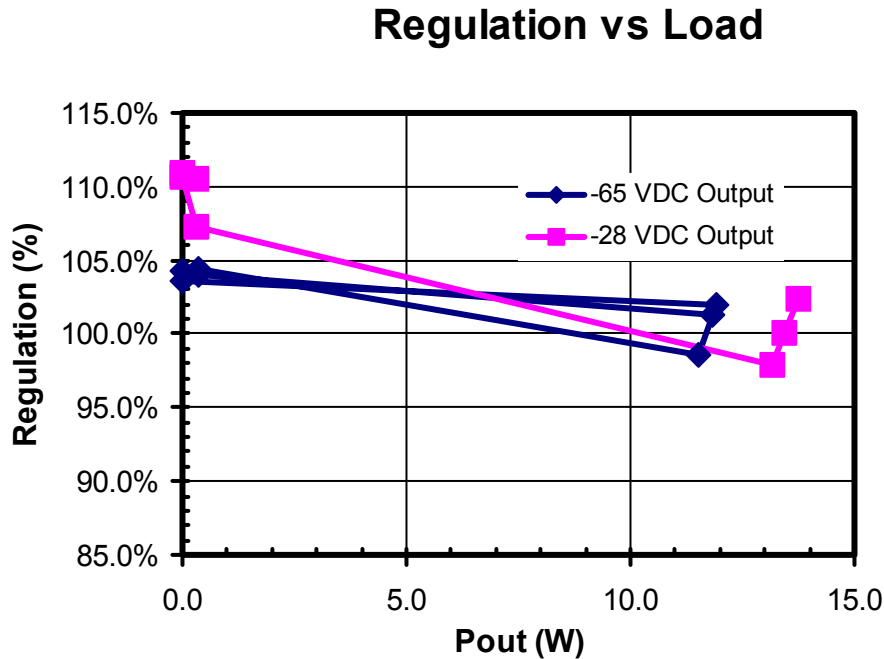

**Figure 6** - 16.5V Output: Efficiency vs. Input Voltage, Room Temperature, 60 Hz.

Note1: the above data was taken with various load combinations of  $-65V$  and  $-28V$  loads.



## 10 Regulation vs. Load



**Figure 7** - 16.5V Output: Regulation vs. Output Load, Room Temperature, 60 Hz.

Note1: the above data was taken with various load combinations of -65V and -28V loads.

Note2: The power supply regulation can be further optimized, by adjusting the relative weighting on output voltage sense resistors R8 and R11. Also the resistor R15 could be increased to lower both output voltages and center them more accurately in the middle of the allowed specification. A min. load could also be added to help the light-load regulation by preventing peak charging on the -28 VDC output.



## 11 Low Load Power Consumption

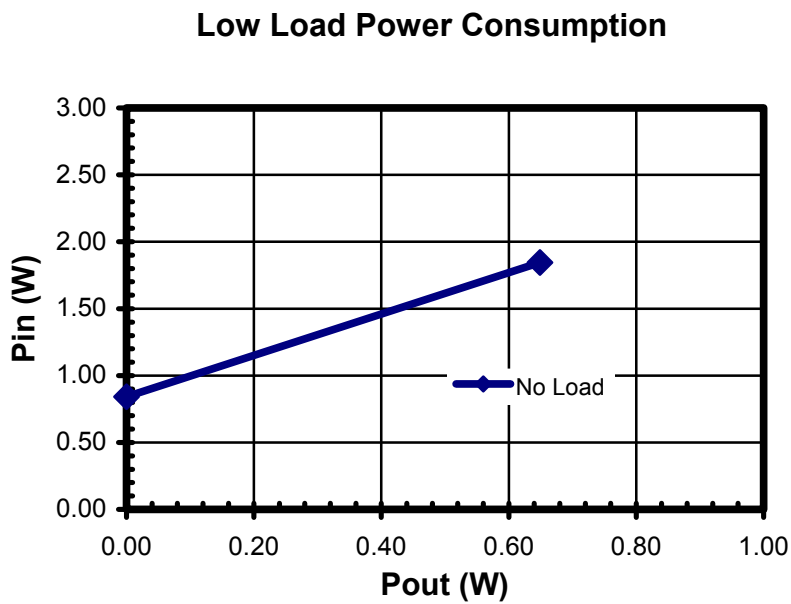

**Figure 8** - No Load/Min. Load Input Consumption at  $-40$  V input (note: min load  $-28$  V @  $10$  mA and  $-65$  V @  $5$  mA)



## 12 Drain Voltage and Current Waveforms

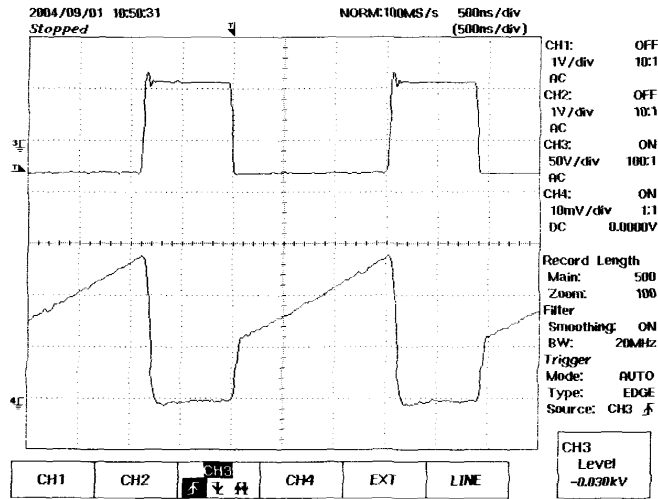

**Figure 9** – Drain Voltage and Current, -32.7 VDC,  
-28 V: 0.48 A; -65 V: 0.18 A  
Top: 50 V/div.  
Bottom: 0.5 A/div, 500 ns / div.

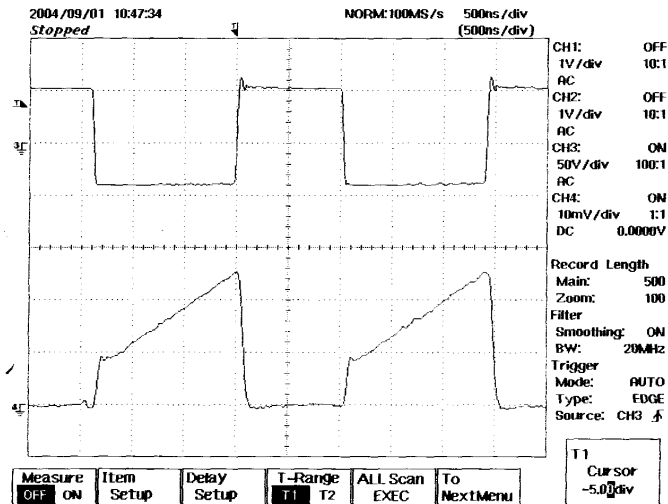

**Figure 10** – Drain Voltage and Current, -40 VDC,  
28 V: 0.48 A; -65 V: 0.18 A  
Top: 50 V/div.  
Bottom: 0.5 A/div, 500 ns / div.





## 13 Transient Load

### *13.1 Transient Load Test Setup*

For transient load tests, additional capacitors were added to eliminate noise pickup during transient load tests (1uF/50V electrolytic in parallel with a 0.1uF/50V ceramic). These were placed at the output of the power supply. From there the lead length to the electronic load was approximately 12 inches to the electronic load. Voltage probes (x1 probes) were placed right at the output of the power supply.



13.2 Transient Load Performance

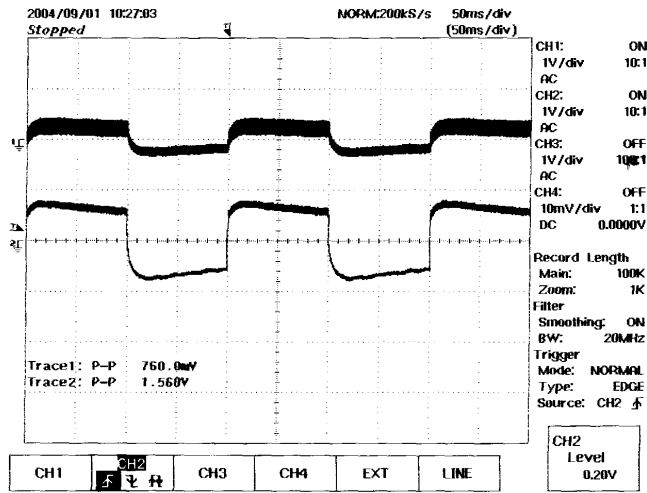

Figure 11 – Transient Response, -40 VDC, -28 V: 0.01 – 0.48 A (100ms-100ms), -65 V: 0.18 A  
 Top: -65 V Voltage, 1V/div.  
 Middle: -28 V Voltage, 1V/div., 50 ms / div.

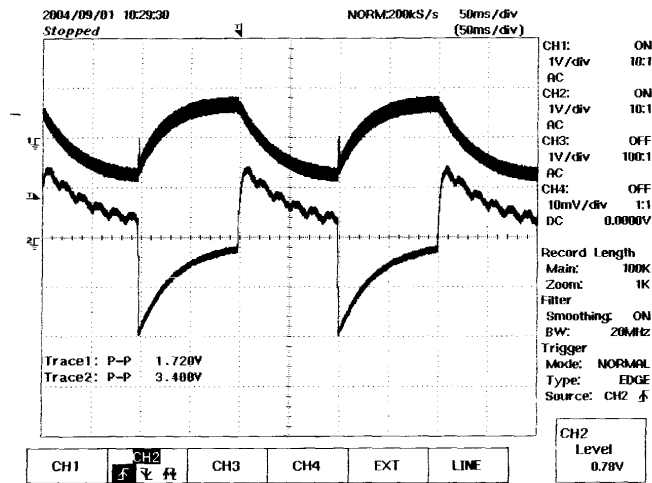

Figure 12 – Transient Response, -40 VDC, 28 V: 0.48 A, -65 V: 0.005 - 0.18 A (100ms-100ms)  
 Top: -65 V Voltage, 1V/div.  
 Middle: 28 V Voltage, 1V/div., 50 ms / div.

## 14 Output Ripple

### 14.1 Output Ripple Measurement Technique

Measurements made at the end of 6ft output cord and a resistor load was used. For DC output ripple measurements, a modified oscilloscope test probe must be utilized in order to reduce spurious signals due to pickup. Details of the probe modification are provided in figure 13 and figure 14.

The 5125BA probe adapter is affixed with two capacitors tied in parallel across the probe tip. The capacitors include one (1) 0.1  $\mu\text{F}/50\text{ V}$  ceramic type and one (1) 1.0  $\mu\text{F}/50\text{ V}$  aluminum electrolytic. **The aluminum electrolytic type capacitor is polarized, so proper polarity across DC outputs must be maintained (see below).**

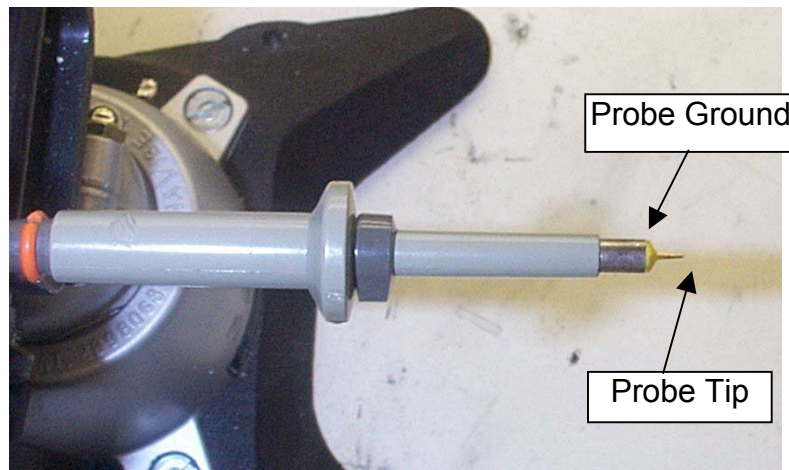
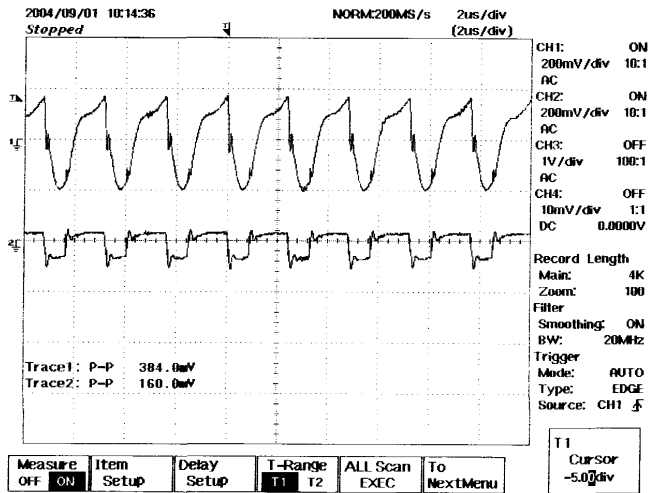

**Figure 13** - Oscilloscope Probe Prepared for Ripple Measurement. (End Cap and Ground Lead Removed)

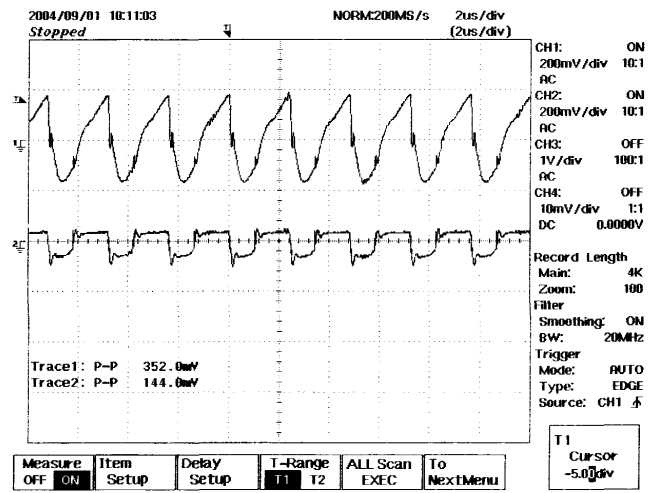

**Figure 14** - Oscilloscope Probe with Probe Master 5125BA BNC Adapter. (Modified with wires for probe ground for ripple measurement, and two parallel decoupling capacitors added)

### 14.2 Full Load Ripple Performance

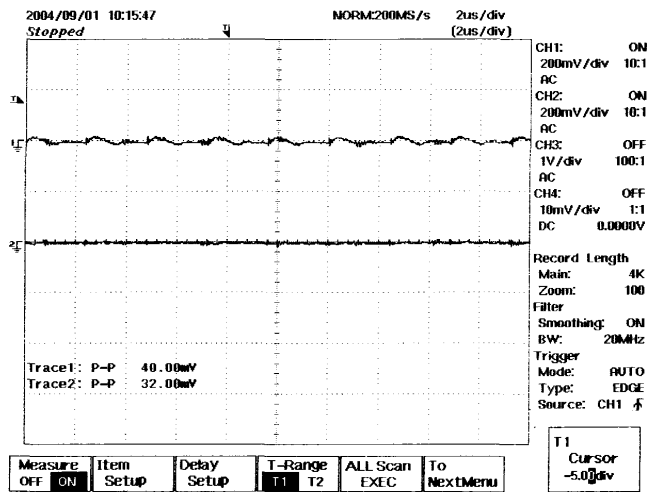

**Figure 15** – Ripple, -32.7 VDC, -28 V: 0.48 A, -65 V: 0.18 A  
 Top: -65 V Voltage, 1V/div.  
 Middle: -28 V Voltage, 1V/div., 2 µs / div.

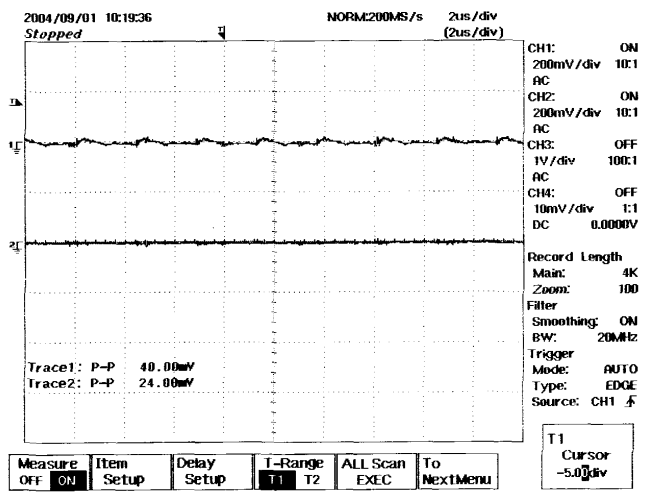

**Figure 16** – Ripple, -40 VDC, -28 V: 0.48 A, 65 V: 0.18 A  
 Top: -65 V Voltage, 1V/div.  
 Middle: -28 V Voltage, 1V/div., 2 µs / div.

### 14.3 No Load Ripple Performance



**Figure 17** – Ripple, -32.7 VDC, -28 V: 0 A, 65 V: 0 A  
 Top: -65 V Voltage, 1V/div.  
 Middle: -28 V Voltage, 1V/div., 2 µs / div.



**Figure 18** – Ripple, -40 VDC, -28 V: 0 A, 65 V: 0 A  
 Top: -65 V Voltage, 1V/div.  
 Middle: -28 V Voltage, 1V/div., 2 µs / div.

## 15 Other Test Results

During short circuit, the following happened:

- for -28 V short circuit, the power supply went into autorestart
- for -65 V short circuit, the power supply shut-down. The power supply would normally go into autorestart under this condition. However, since the -40 VDC input rail is used to derive the output of -65 VDC, when the -65 VDC output is shorted, this also shorts the input voltage and causes the power supply to go into under-voltage shutdown (which occurs when the input voltage drops below ~ 32 VDC).



## 16 Revision History

<b>Date</b>	<b>Author</b>	<b>Revision</b>	<b>Description &amp; changes</b>	<b>Reviewed</b>
November 18, 2004	RM	1.0	First release	VC / AM



For the latest updates, visit our Web site: [www.powerint.com](http://www.powerint.com)

Power Integrations may make changes to its products at any time. Power Integrations has no liability arising from your use of any information, device or circuit described herein nor does it convey any license under its patent rights or the rights of others. POWER INTEGRATIONS MAKES NO WARRANTIES HEREIN AND SPECIFICALLY DISCLAIMS ALL WARRANTIES INCLUDING, WITHOUT LIMITATION, THE IMPLIED WARRANTIES OF MERCHANTABILITY, FITNESS FOR A PARTICULAR PURPOSE, AND NON-INFRINGEMENT OF THIRD PARTY RIGHTS.

#### PATENT INFORMATION

The products and applications illustrated herein (including circuits external to the products and transformer construction) may be covered by one or more U.S. and foreign patents or potentially by pending U.S. and foreign patent applications assigned to Power Integrations. A complete list of Power Integrations' patents may be found at [www.powerint.com](http://www.powerint.com).

The PI Logo, **TOPSwitch**, **TinySwitch**, **LinkSwitch**, and **EcoSmart** are registered trademarks of Power Integrations. **PI Expert** and **DPA-Switch** are trademarks of Power Integrations.

© Copyright 2004, Power Integrations.

### Power Integrations Worldwide Sales Support Locations

#### WORLD HEADQUARTERS

5245 Hellyer Avenue,  
San Jose, CA 95138, USA  
Main: +1-408-414-9200  
Customer Service:  
Phone: +1-408-414-9665  
Fax: +1-408-414-9765  
e-mail:  
[usasales@powerint.com](mailto:usasales@powerint.com)

#### GERMANY

Rueckertstrasse 3,  
D-80336, Munich, Germany  
Phone: +49-895-527-3910  
Fax: +49-895-527-3920  
e-mail: [eurosales@powerint.com](mailto:eurosales@powerint.com)

#### JAPAN

Keihin-Tatemono 1st Bldg.  
12-20 Shin-Yokohama,  
2-Chome,  
Kohoku-ku, Yokohama-shi,  
Kanagawa 222-0033, Japan  
Phone: +81-45-471-1021  
Fax: +81-45-471-3717  
e-mail:  
[japansales@powerint.com](mailto:japansales@powerint.com)

#### TAIWAN

17F-3, No. 510,  
Chung Hsiao E. Rd., Sec. 5,  
Taipei, Taiwan 110, R.O.C.  
Phone: +886-2-2727-1221  
Fax: +886-2-2727-1223  
e-mail:  
[taiwansales@powerint.com](mailto:taiwansales@powerint.com)

#### CHINA (SHANGHAI)

Rm 807, Pacheer,  
Commercial Centre,  
555 Nanjing West Road,  
Shanghai, 200041, China  
Phone: +86-21-6215-5548  
Fax: +86-21-6215-2468  
e-mail:  
[chinasales@powerint.com](mailto:chinasales@powerint.com)

#### INDIA (TECHNICAL SUPPORT)

Innovatech  
261/A, Ground Floor  
7th Main, 17th Cross,  
Sadashivanagar  
Bangalore, India, 560080  
Phone: +91-80-5113-8020  
Fax: +91-80-5113-8023  
e-mail: [indiasales@powerint.com](mailto:indiasales@powerint.com)

#### KOREA

8th Floor, DongSung Bldg.  
17-8 Yoido-dong,  
Youngdeungpo-gu,  
Seoul, 150-874, Korea  
Phone: +82-2-782-2840  
Fax: +82-2-782-4427  
e-mail:  
[koreasales@powerint.com](mailto:koreasales@powerint.com)

#### UK (EUROPE & AFRICA HEADQUARTERS)

1st Floor, St. James's House  
East Street  
Farnham, Surrey GU9 7TJ  
United Kingdom  
Phone: +44-1252-730-140  
Fax: +44-1252-727-689  
e-mail: [eurosales@powerint.com](mailto:eurosales@powerint.com)

#### CHINA (SHENZHEN)

Rm# 1705, Bao Hua Bldg.  
1016 Hua Qiang Bei Lu,  
Shenzhen, Guangdong,  
518031, China  
Phone: +86-755-8367-5143  
Fax: +86-755-8377-9610  
e-mail:  
[chinasales@powerint.com](mailto:chinasales@powerint.com)

#### ITALY

Via Vittorio Veneto 12, Bresso,  
Milano,  
20091, Italy  
Phone: +39-028-928-6001  
Fax: +39-028-928-6009  
e-mail: [eurosales@powerint.com](mailto:eurosales@powerint.com)

#### SINGAPORE

51 Newton Road,  
#15-08/10 Goldhill Plaza,  
Singapore, 308900  
Phone: +65-6358-2160  
Fax: +65-6358-2015  
e-mail:  
[singaporeales@powerint.com](mailto:singaporeales@powerint.com)

#### APPLICATIONS HOTLINE

World Wide +1-408-414-9660

#### APPLICATIONS FAX

World Wide +1-408-414-9760

ER or EPR template – Rev 3.6 – Single sided

