



## Design Example Report

<b>Title</b>	<i>17.4 W Power Supply using TOP244P</i>
<b>Specification</b>	Input: 160 – 275 VAC Output: 3.3V/1.0A, 5.1V/1.0A, 9.0V/1.0A
<b>Application</b>	Set Top Box
<b>Author</b>	Power Integrations Applications Department
<b>Document Number</b>	DER-99
<b>Date</b>	September 12, 2005
<b>Revision</b>	1.0

### Summary and Features

This report describes a prototype design for a Set Top Box using a **TOPSwitch-GX** TOP244P, featuring:

- Self-recovering AC Line Overvoltage shutdown to prevent damage during high voltage swells
- Meets 388 VAC swell
- Meets 6 kV surge
- Low EMI
- Small common mode choke
- Small Y-cap
- A low cost secondary 'power good' detection circuit

The products and applications illustrated herein (including circuits external to the products and transformer construction) may be covered by one or more U.S. and foreign patents or potentially by pending U.S. and foreign patent applications assigned to Power Integrations. A complete list of Power Integrations' patents may be found at [www.powerint.com](http://www.powerint.com).

## Table Of Contents

1	Introduction.....	4
2	Power Supply Specification.....	5
3	Schematic.....	6
4	Circuit Description .....	8
4.1	EMI Filtering.....	8
4.2	TOPSwitch Primary.....	8
4.3	Power Good signal.....	8
5	PCB Layout.....	9
6	Bill Of Materials .....	10
7	Transformer Specification.....	12
7.1	Electrical Diagram .....	12
7.2	Electrical Specifications.....	12
7.3	Materials.....	12
7.4	Transformer Build Diagram .....	13
7.5	Transformer Construction.....	14
8	Transformer Spreadsheets.....	15
9	Performance Data .....	18
9.1	Efficiency.....	18
9.2	Regulation .....	18
9.2.1	Cross Regulation.....	18
9.3	Thermal Performance.....	18
9.4	Surge test.....	19
9.4.1	Surge Test Setup .....	19
9.4.2	Surge Test Results.....	19
9.5	AC Line Over Voltage (388 VAC swell) .....	20
9.6	Hold-Up Time and Power Good .....	21
10	Waveforms.....	23
10.1	Drain Voltage and Current, Normal Operation .....	23
10.2	Drain Voltage and Current Start-up Profile.....	23
10.3	Output Ripple Measurements.....	24
10.3.1	Ripple Measurement Technique .....	24
10.3.2	Measurement Results .....	25
11	Control Loop Measurements.....	26
11.1	160 VAC Maximum Load .....	26
11.2	230 VAC Maximum Load .....	26
12	Conducted EMI .....	27
13	Revision History.....	28



**Important Notes:**

Although this board is designed to satisfy safety isolation requirements, the engineering prototype has not been agency approved. Therefore, all testing should be performed using an isolated source to provide power to the prototype board.

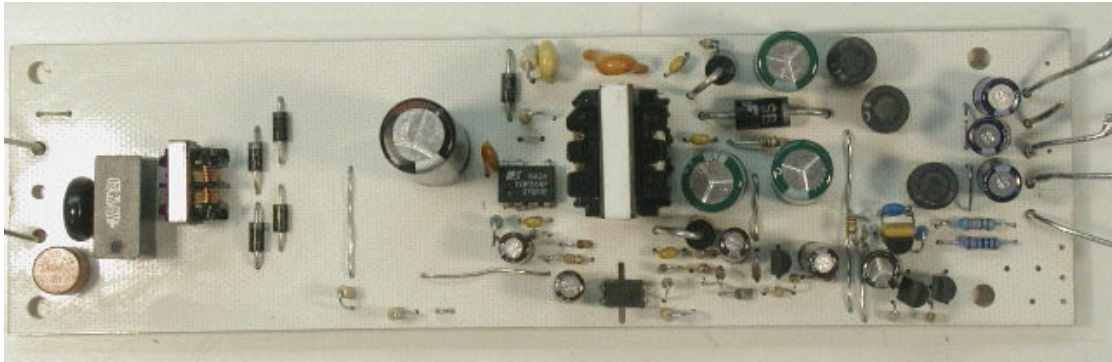
Design Reports contain a power supply design specification, schematic, bill of materials, and transformer documentation. Performance data and typical operation characteristics are included. Typically only a single prototype has been built.



## 1 Introduction

This document is an engineering report describing a Set-top power supply utilizing a TOP244P.

The document contains the power supply specification, schematic, bill of materials, transformer documentation, printed circuit layout, and performance data.



**Figure 1** – Populated Circuit Board Photograph



## 2 Power Supply Specification

Description	Symbol	Min	Typ	Max	Units	Comment
<b>Input</b> Voltage Frequency	$V_{IN}$ $f_{LINE}$	160 47	230 50/60	275 63	VAC Hz	2 Wire – no P.E.
<b>Output</b> Output Voltage 1 Output Ripple Voltage 1 Output Current 1	$V_{OUT1}$ $V_{RIPPLE1}$ $I_{OUT1}$	3.135 0.30	3.30	3.465 50 1.00	V mV A	20 MHz bandwidth
Output Voltage 2 Output Ripple Voltage 2 Output Current 2	$V_{OUT1}$ $V_{RIPPLE1}$ $I_{OUT1}$	4.85 0.020	5.10	5.35 50 1.00	V mV A	20 MHz bandwidth
Output Voltage 3 Output Ripple Voltage 3 Output Current 3	$V_{OUT1}$ $V_{RIPPLE1}$ $I_{OUT1}$	8.40 0.25	9.00	9.60 50 1.00	V mV A	20 MHz bandwidth
<b>Total Output Power</b> Continuous Output Power	$P_{OUT}$			17.4	W	
<b>Efficiency</b> Full Load	$\eta$	70			%	230VAC, 25 °C
<b>Environmental</b> Conducted EMI Safety						Meets CISPR22B / EN55022B Designed to meet IEC950, UL1950 Class II
Surge				6	kV	100 kHz ring wave, 200 A short circuit current, differential and common mode
Ambient Temperature	$T_{AMB}$			65	°C	Free convection, sea level



### 3 Schematic

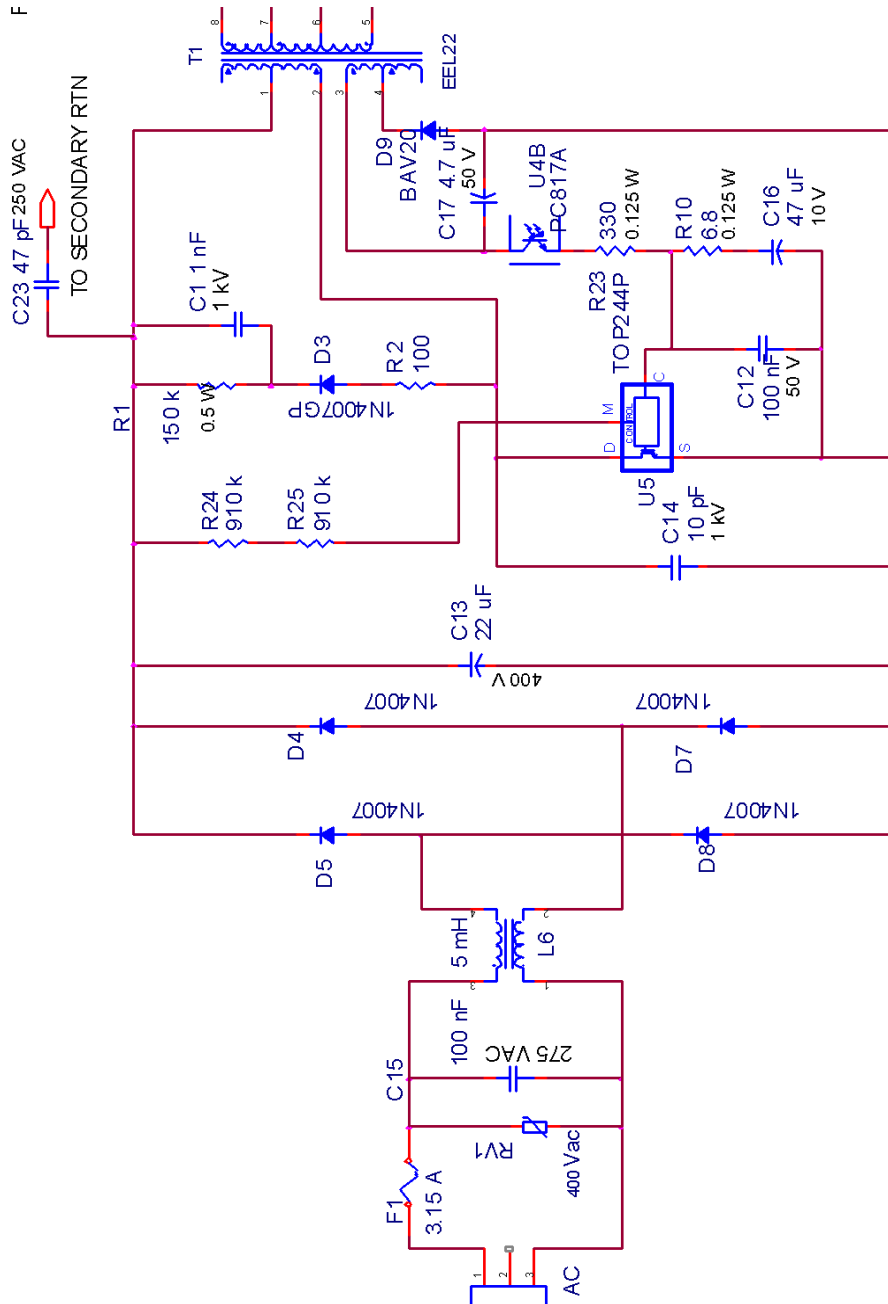


Figure 2 – Schematic. Primary Side



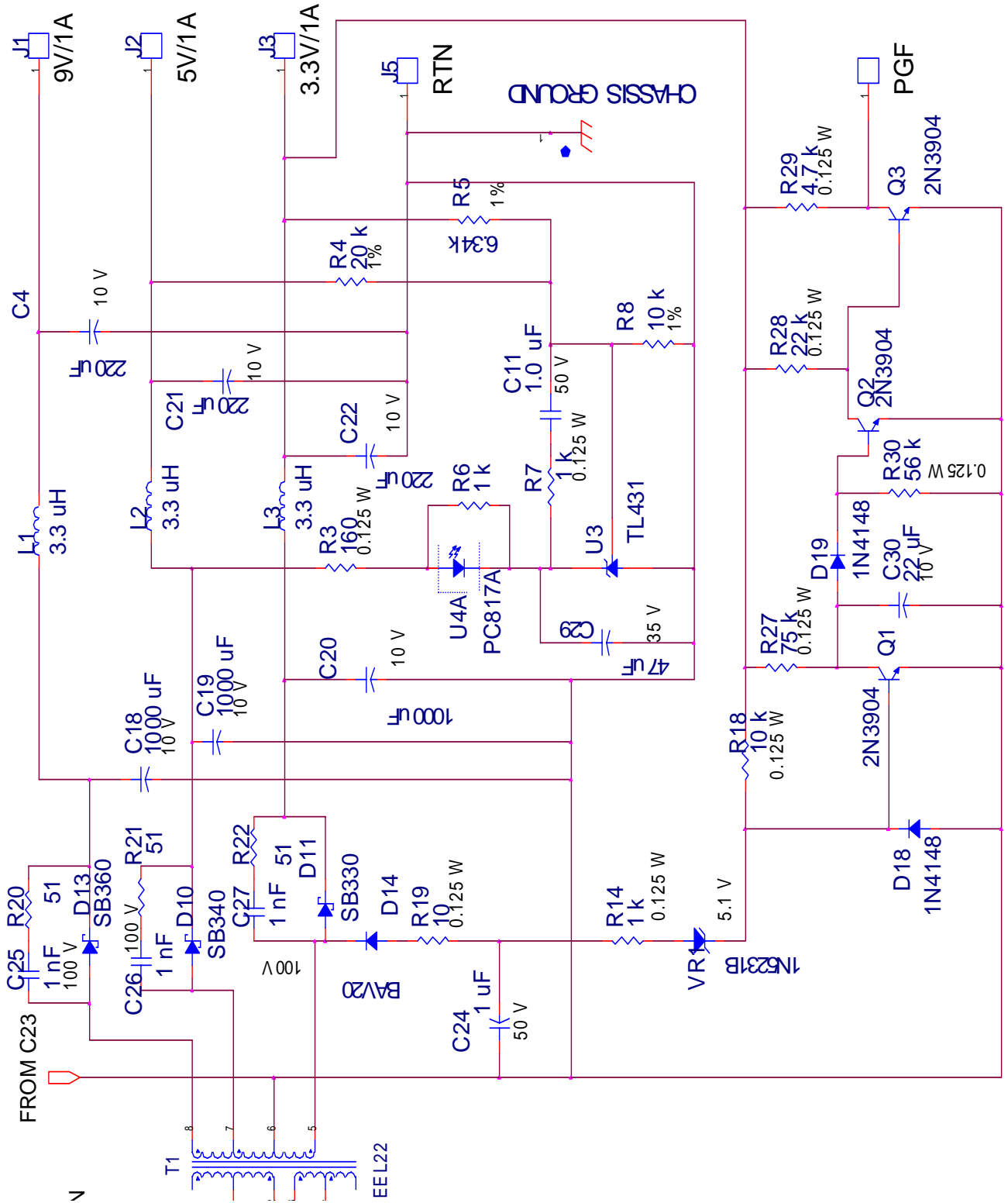


Figure 3 – Schematic Secondary Side



## 4 Circuit Description

### 4.1 EMI Filtering

L6 and C15 form the main EMI filter. C23 and C14 reduce radiated EMI, and the RC networks across the output diodes also reduce high frequency conducted and radiated EMI.

### 4.2 TOPSwitch Primary

The TOPSwitch has a built-in bulk voltage OVLO (over-voltage lockout) protection. It senses the bulk voltage through R24 and R25. If the bulk voltage exceeds the set threshold, it will shutdown until the voltage falls back to safe levels. This will prevent failure due to Drain over-voltage during an AC voltage swell.

### 4.3 Power Good signal

Q1, Q2, Q3 and associated circuitry form the power-good signal. D14 charges C24 during the on-time of the TOP244P, and form a “forward mode” output. C24 has a negative voltage that is proportional to the bulk capacitor when the TP244P is running. VR1 and Q1 sense when the bulk cap is below a certain threshold. When AC power is removed, the bulk voltage drops and Q1 turns on, rapidly discharging C30, turning off Q2 and turning Q3 on, and the power-good signal output goes low. This bulk voltage threshold, and zener VR1 voltage is chosen so that this happens >5mS before the outputs drop out of regulation when at full load. R27 and C30 form a delay so that at power-up, the power-good signal is delayed >500 mS before it comes up.





## 5 PCB Layout

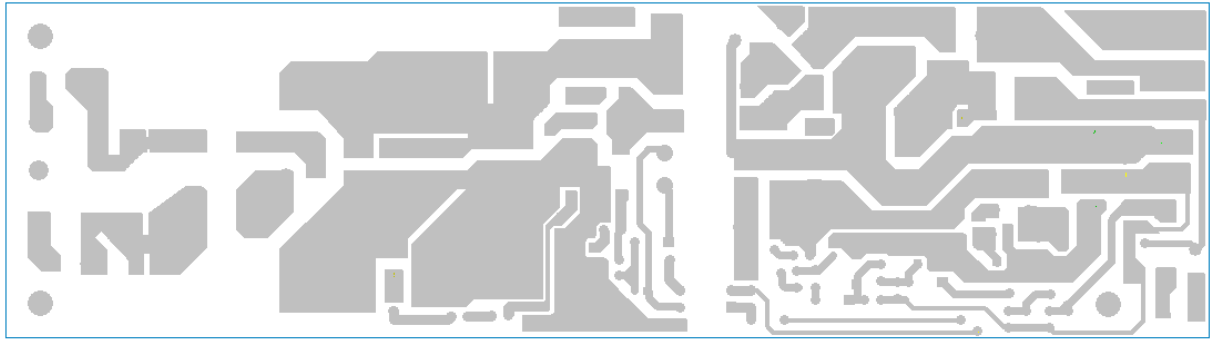


Figure 4 – Printed Circuit Layout

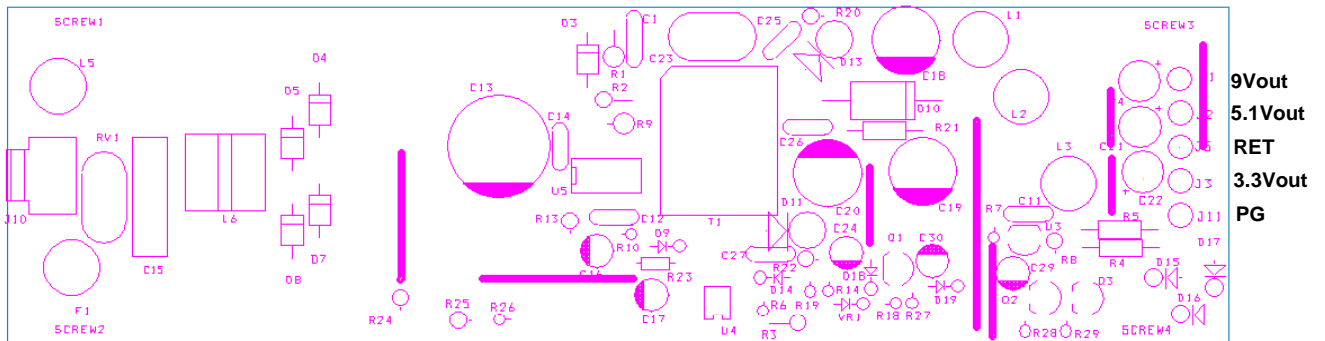


Figure 5 – Silk Screen



## 6 Bill Of Materials

Item Number	Quantity	Value	Description	Part Reference
1	1	1 nF	1 nF, 1 kV, Disc Ceramic	C1
2	3	220 uF	220 uF, 10 V, Electrolytic, Gen. Purpose, (6.3 x 11)	C4 C21 C22
3	1	1.0 uF	1.0 uF, 50 V, Ceramic, X7R	C11
4	1	100 nF	100 nF, 50 V, Ceramic, X7R	C12
5	1	22 uF	22 uF, 400 V, Electrolytic, Low ESR, 901 mOhm, (16 x 20)	C13
6	1	10 pF	10 pF, 1 kV, Disc Ceramic	C14
7	1	100 nF	100 nF, 275 VAC, Film, X2	C15
8	1	47 uF	47 uF, 10 V, Electrolytic, Gen. Purpose, (5 x 11)	C16
9	1	4.7 uF	4.7 uF, 50 V, Electrolytic, Gen. Purpose, (5 x 11)	C17
10	3	1000 uF	1000 uF, 10 V, Electrolytic, Very Low ESR, 38 mOhm, (10 x 16)	C18 C19 C20
11	1	47 pF	47 pF, Ceramic, Y1	C23
12	1	1 uF	1 uF, 50 V, Electrolytic, Gen. Purpose, (5 x 11)	C24
13	3	1 nF	1 nF, 100 V, Ceramic, COG	C25 C26 C27
14	1	47 uF	47 uF, 35 V, Electrolytic, Gen. Purpose, (5 x 11)	C29
15	1	22 uF	22 uF, 10 V, Electrolytic, Gen. Purpose, (5 x 11)	C30
16	1	1N4007GP	1000 V, 1 A, Rectifier, Glass Passivated, 2 us, DO-41	D3
17	4	1N4007	1000 V, 1 A, Rectifier, DO-41	D4 D5 D7 D8
18	2	BAV20	200 V, 200 mA, Fast Switching, 50 ns, DO-35	D9 D14
19	1	SB340	40 V, 3 A, Schottky, DO-201AD	D10
20	1	SB330	30 V, 3 A, Schottky, DO-201AD	D11
21	1	SB360	60 V, 3 A, Schottky, DO-201AD	D13
22	2	1N4148	75 V, 300 mA, Fast Switching, DO-35	D18 D19
23	1	3.15 A	3.15 A, 250V, Fast, TR5	F1
24	3	3.3 uH	3.3 uH, 2.66 A	L1 L2 L3
25	1	5 mH	5 mH, 0.3 A, Common Mode Choke	L6
26	3	2N3904	NPN, Small Signal BJT, 40 V, 0.2 A, TO-92	Q1 Q2 Q3
27	1	150 k	150 k, 5%, 1/2 W, Carbon Film	R1
28	1	100	100 R, 5%, 1/4 W, Carbon Film	R2
29	1	160	160 R, 5%, 1/8 W, Carbon Film	R3
30	1	20 k	20 k, 1%, 1/4 W, Metal Film	R4
31	1	6.34 k	6.34 k, 1%, 1/4 W, Metal Film	R5
32	3	1 k	1 k, 5%, 1/8 W, Carbon Film	R6 R7 R14
33	1	10 k	10 k, 1%, 1/4 W, Metal Film	R8
34	1	6.8	6.8 R, 5%, 1/8 W, Carbon Film	R10
35	1	10 k	10 k, 5%, 1/8 W, Carbon Film	R18
36	1	10	10 R, 5%, 1/8 W, Carbon Film	R19
37	3	51	51 R, 5%, 1/4 W, Carbon Film	R20 R21 R22
38	1	330	330 R, 5%, 1/8 W, Carbon Film	R23
39	1	910 k	910 k, 5%, 1/4 W, Carbon Film	R24
40	1	910 k	910 k, 5%, 1/4 W, Carbon Film	R25
41	1	75 k	75 k, 5%, 1/8 W, Carbon Film	R27
42	1	22 k	22 k, 5%, 1/8 W, Carbon Film	R28
43	1	4.7 k	4.7 k, 5%, 1/8 W, Carbon Film	R29



44	1	56 k	56 k, 5%, 1/8 W, Carbon Film	R30
45	1	400 Vac	MOV, 400V, 80J, 10 mm, RADIAL	RV1
46	1	EEL22	Custom Transformer LP=800uH	T1
47	1	TL431	2.495 V Shunt Regulator IC, 2%, 0 to 70C, TO-92	U3
48	1	PC817A	Opto coupler, 35 V, CTR 80-160%, 4-DIP	U4
49	1	TOP244P	TOPSwitch-GX, TOP244P, DIP-8B	U5
50	1	1N5231B	5.1 V, 5%, 500 mW, DO-35	VR1



## 7 Transformer Specification

### 7.1 Electrical Diagram

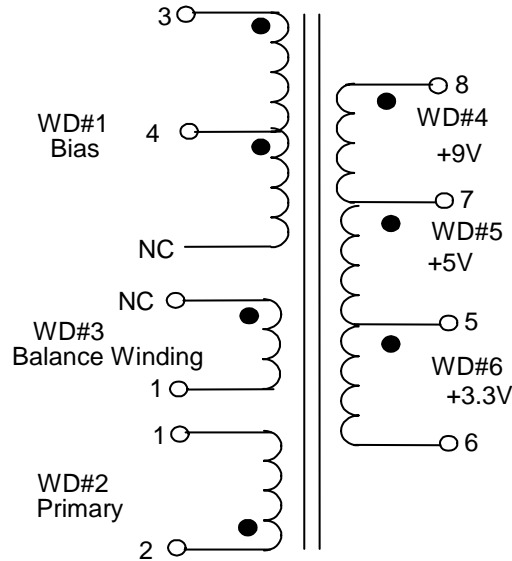


Figure 6 – Transformer Electrical Diagram

### 7.2 Electrical Specifications

<b>Electrical Strength</b>	60 second, 60 Hz, from Pins 1,2,3,4 to Pins 5,6,7, 8	3000 VAC
<b>Primary Inductance</b>	Pins 1 to 2, all other windings open, measured at 132 kHz	800 $\mu$ H, -/+10%
<b>Resonant Frequency</b>	Pins 1 to 2, all other windings open, measured at	1233 kHz (Min.)
<b>Primary Leakage Inductance</b>	Pins 1-2, with Pins 5,6,7,8 shorted, measured at 132 kHz.	35 $\mu$ H (Max.)

### 7.3 Materials

Item	Description
[1]	Core: PC40EEL22, TDK or equivalent Gapped for AL of 222 nH/T <sup>2</sup>
[2]	Bobbin: EEL22 Vertical 8 pin
[3]	Magnet Wire: 29AWG
[4]	Magnet Wire: 34AWG
[5]	Magnet Wire: 27AWG
[6]	Copper Foil: 0.1mm*8.5mm
[7]	Tape: 3M 44 Polyester Film, 5.5 mils thick, 6 mm wide
[8]	Tape: 3M 44 Polyester Film, 5.5 mils thick, 3 mm wide
[9]	Tape: 3M 1298 Polyester Film, 2.0 mils thick, 9 mm wide
[10]	Tape: 3M 1298 Polyester Film, 2.0 mils thick, 18mm wide
[11]	Varnish



### 7.4 Transformer Build Diagram

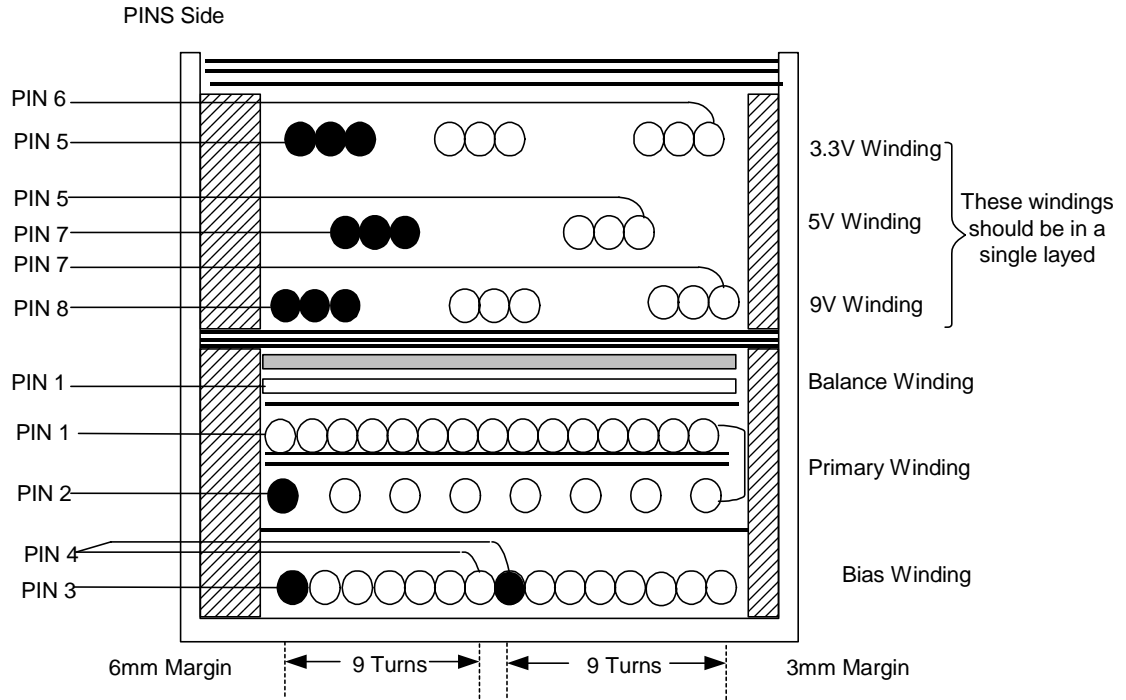


Figure 7 – Transformer Build Diagram

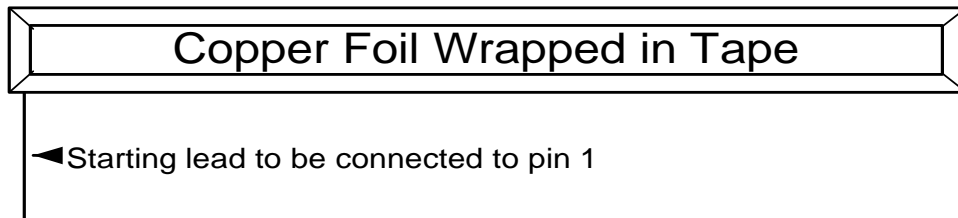


Figure 8 – Copper foil preparation for winding #3



### 7.5 Transformer Construction

<b>Bobbin Orientation</b>	Place bobbin, item [2] with the pin side oriented to the left hand side
<b>Safety Margin</b>	Wind margin tape, item [7] on the pin side of the bobbin. Also wind margin tape, item [8] on the top side of the bobbin. Match the height of the tape with the height of the primary side windings.
<b>Bias Winding</b>	Start at Pin3. Wind 9 turns of item [3] from left to right. Bring the wire lead out and connect it to pin 4. Then bring the wire lead back to the winding area to continue winding 9 more turns from left to right on the same layer. The layer should be uniformly covering the whole winding area. Cut the finish lead at the end of the winding.
<b>Tape</b>	1 layer of item [9] for basic insulation.
<b>Primary</b>	Start at pin 2, wind 20 turns of item [4] from left to right. Distribute the 20 turns uniformly scattered on the whole winding area. Add two layers of tape, item [9]. Wind 40 more turns on a second layer from right to left. Wind tightly and uniformly across whole layer. Finish on pin 1
<b>Basic Insulation</b>	1 layer of item [9] for basic insulation.
<b>Balance Winding</b>	Start on pin 1 using item [6] as shown in figure 7. <b>Start at pin 1. Wind 2 turns in reverse winding direction.</b> Finish lead is not connected.
<b>Insulation</b>	Use 3 layers of item [10] for basic insulation
<b>Safety Margin</b>	Wind margin tape, item [7] on the pin side of the bobbin. Also wind margin tape, item [8] on the top side of the bobbin. Match the height of the tape with the height of the secondary side windings.
<b>9V, 5V and 3V3 Winding</b>	<b>Wind secondary winding in Normal winding direction.</b> The three windings should be wound in a single layer scattered along the winding area. 9V Winding. Two trifilar turns of item [5] from left to right. Start at pin 8, finish at pin 7 5V Winding. One trifilar turn of item [5] from left to right. Start at pin 7, finish at pin 5 3.3 V Winding. Two trifilar turns of item [5] from left to right. Start at pin 5, finish at pin 6
<b>Insulation</b>	Apply 3 layer item [10]
<b>Final Assembly</b>	Assemble and secure core halves [1] with bobbin [2] Varnish impregnate item [11]



## 8 Transformer Spreadsheets

ACDC_TOPSwitchGX_032 204; Rev.1.9; Copyright Power Integrations Inc. 2004	INPUT	INFO	INFO	OUTP UT	OUTP UT	UNIT	TOP_GX_FX_032204.xls: TOPSwitch-GX/FX Continuous/Discontinuous Flyback Transformer Design Spreadsheet
ENTER APPLICATION VARIABLES							Customer
VACMIN	160					Volts	Minimum AC Input Voltage
VACMAX	275					Volts	Maximum AC Input Voltage
fL	50					Hertz	AC Mains Frequency
VO	5					Volts	Output Voltage
PO	17.4					Watts	Output Power
n	0.72						Efficiency Estimate
Z	0.5						Loss Allocation Factor
VB	15					Volts	Bias Voltage
tC	3					mSeco nds	Bridge Rectifier Conduction Time Estimate
CIN	22					uFarad s	Input Filter Capacitor
ENTER TOPSWITCH-GX VARIABLES							
TOP-GX	TOP24 3					Univer sal	115 Doubled/230V
Chosen Device		TOP24 3	TOP24 3	Power Out	Power Out	30W	45W
KI	1						External Ilimit reduction factor (KI=1.0 for default ILIMIT, KI <1.0 for lower ILIMIT)
ILIMITMIN				0.837	0.837	Amps	Use 1% resistor in setting external ILIMIT
ILIMITMAX				0.963	0.963	Amps	Use 1% resistor in setting external ILIMIT
Frequency (F)=132kHz, (H)=66kHz	F						Full (F) frequency option - 132kHz
fS				13200 0	13200 0	Hertz	TOPSwitch-GX Switching Frequency: Choose between 132 kHz and 66 kHz
fSmin				12400 0	12400 0	Hertz	TOPSwitch-GX Minimum Switching Frequency
fSmax				14000 0	14000 0	Hertz	TOPSwitch-GX Maximum Switching Frequency
VOR	110					Volts	Reflected Output Voltage
VDS	10					Volts	TOPSwitch on-state Drain to Source Voltage
VD	0.5					Volts	Output Winding Diode Forward Voltage Drop
VDB	0.7					Volts	Bias Winding Diode Forward Voltage Drop
KP	0.9632 6036						Ripple to Peak Current Ratio (0.4 < KRP < 1.0 : 1.0< KDP<6.0)
ENTER TRANSFORMER CORE/CONSTRUCTION VARIABLES							
Core Type	EEL22						
Core		EEL22	EEL22			P/N:	PC40EE22/29/6-Z
Bobbin		EEL22 _BOB BIN	EEL22_BOBBI N			P/N:	*
AE				0.358	0.358	cm^2	Core Effective Cross Sectional Area
LE				6.32	6.32	cm	Core Effective Path Length
AL				1400	1400	nH/T^2	Ungapped Core Effective Inductance
BW				18	18	mm	Bobbin Physical Winding Width
M	4.5					mm	Safety Margin Width (Half the Primary to Secondary Creepage Distance)
L	1.5						Number of Primary Layers
NS	3						Number of Secondary Turns
DC INPUT VOLTAGE PARAMETERS							
VMIN				189	189	Volts	Minimum DC Input Voltage
VMAX				389	389	Volts	Maximum DC Input Voltage
CURRENT WAVEFORM SHAPE							



PARAMETERS						
DMAX				0.38	0.38	Maximum Duty Cycle
I AVG				0.13	0.13	Amps Average Primary Current
IP				0.65	0.65	Amps Peak Primary Current
IR				0.62	0.62	Amps Primary Ripple Current
IRMS				0.23	0.23	Amps Primary RMS Current
TRANSFORMER PRIMARY DESIGN PARAMETERS						
LP				800	800	uHenries Primary Inductance
NP				60	60	Primary Winding Number of Turns
NB				9	9	Bias Winding Number of Turns
ALG				222	222	nH/T^2 Gapped Core Effective Inductance
BM				2412	2412	Gauss Maximum Flux Density at PO, VMIN (BM<3000)
BP				3587	3587	Gauss Peak Flux Density (BP<4200)
BAC				1162	1162	Gauss AC Flux Density for Core Loss Curves (0.5 X Peak to Peak)
ur				1967	1967	Relative Permeability of Ungapped Core
LG				0.17	0.17	mm Gap Length (Lg > 0.1 mm)
BWE				13.5	13.5	mm Effective Bobbin Width
OD				0.23	0.23	mm Maximum Primary Wire Diameter including insulation
INS				0.04	0.04	mm Estimated Total Insulation Thickness (= 2 * film thickness)
DIA				0.18	0.18	mm Bare conductor diameter
AWG				34	34	AWG Primary Wire Gauge (Rounded to next smaller standard AWG value)
CM				40	40	Cmils Bare conductor effective area in circular mils
CMA		Warnin g	Warnin g	172	172	Cmils/Amp !!!!!!!!! INCREASE CMA>200 (increase L(primary layers),decrease NS,larger Core)
TRANSFORMER SECONDARY DESIGN PARAMETERS (SINGLE OUTPUT / SINGLE OUTPUT EQUIVALENT)						
Lumped parameters						
ISP				12.96	12.96	Amps Peak Secondary Current
ISRMS				6.00	6.00	Amps Secondary RMS Current
IO				3.48	3.48	Amps Power Supply Output Current
IRIPPLE				4.89	4.89	Amps Output Capacitor RMS Ripple Current
CMS				1200	1200	Cmils Secondary Bare Conductor minimum circular mils
AWGS				19	19	AWG Secondary Wire Gauge (Rounded up to next larger standard AWG value)
DIAS				0.91	0.91	mm Secondary Minimum Bare Conductor Diameter
ODS				3.00	3.00	mm Secondary Maximum Outside Diameter for Triple Insulated Wire
INSS				1.04	1.04	mm Maximum Secondary Insulation Wall Thickness
VOLTAGE STRESS PARAMETERS						
VDRAIN				640	640	Volts Maximum Drain Voltage Estimate (Includes Effect of Leakage Inductance)
PIVS				24	24	Volts Output Rectifier Maximum Peak Inverse Voltage
PIVB				71	71	Volts Bias Rectifier Maximum Peak Inverse Voltage
TRANSFORMER SECONDARY DESIGN PARAMETERS (MULTIPLE OUTPUTS)						
1st output						
VO1	5.1					Volts Output Voltage
IO1	1.000					Amps Output DC Current
PO1				5.10	5.10	Watts Output Power
VD1	0.5					Volts Output Diode Forward Voltage Drop
NS1				3.05	3.05	Output Winding Number of Turns
ISRMS1				1.724	1.724	Amps Output Winding RMS Current
IRIPPLE1				1.40	1.40	Amps Output Capacitor RMS Ripple Current
PIVS1				25	25	Volts Output Rectifier Maximum Peak Inverse Voltage





CMS1				345	345	Cmils	Output Winding Bare Conductor minimum circular mils
AWGS1				24	24	AWG	Wire Gauge (Rounded up to next larger standard AWG value)
DIAS1				0.51	0.51	mm	Minimum Bare Conductor Diameter
ODS1				2.95	2.95	mm	Maximum Outside Diameter for Triple Insulated Wire
2nd output							
VO2	3.3					Volts	Output Voltage
IO2	1.000					Amps	Output DC Current
PO2				3.30	3.30	Watts	Output Power
VD2	0.5					Volts	Output Diode Forward Voltage Drop
NS2				2.07	2.07		Output Winding Number of Turns
ISRMS2				1.724	1.724	Amps	Output Winding RMS Current
IRIPPLE2				1.40	1.40	Amps	Output Capacitor RMS Ripple Current
PIVS2				17	17	Volts	Output Rectifier Maximum Peak Inverse Voltage
CMS2							
AWGS2				24	24	AWG	Wire Gauge (Rounded up to next larger standard AWG value)
DIAS2				0.51	0.51	mm	Minimum Bare Conductor Diameter
ODS2				4.34	4.34	mm	Maximum Outside Diameter for Triple Insulated Wire
3rd output							
VO3	9.0					Volts	Output Voltage
IO3	1.000					Amps	Output DC Current
PO3				9.00	9.00	Watts	Output Power
VD3	0.5					Volts	Output Diode Forward Voltage Drop
NS3				5.18	5.18		Output Winding Number of Turns
ISRMS3				1.724	1.724	Amps	Output Winding RMS Current
IRIPPLE3				1.40	1.40	Amps	Output Capacitor RMS Ripple Current
PIVS3				43	43	Volts	Output Rectifier Maximum Peak Inverse Voltage
CMS3							
AWGS3				24	24	AWG	Wire Gauge (Rounded up to next larger standard AWG value)
DIAS3				0.51	0.51	mm	Minimum Bare Conductor Diameter
ODS3				1.74	1.74	mm	Maximum Outside Diameter for Triple Insulated Wire
Total power				17.4	17.4	Watts	Total Power for Multi-output section



## 9 Performance Data

All measurements performed at room temperature, 60 Hz input frequency.

### 9.1 Efficiency

VIN (AC)	Input Power (W)	Total PO (W)	Output Efficiency (%)
160	21.7	17.11	78.85
230	21.8	17.11	78.49

Figure 9 – Efficiency Data. Each Output is loaded at 1.0Amp. Room Temperature, 60 Hz.

### 9.2 Regulation

#### 9.2.1 Cross Regulation

VIN (AC)	OUT LOAD (ADC)			MEASURED OUTPUT VOLTAGE (DC)		
	3.3 V	5 V	9 V	3.3 V	5 V	9 V
				(3.135--3.465)	(4.85--5.35)	(8.40--9.60)
<b>160VAC</b>	0.300	0.020	0.250	3.23	5.21	8.70
	0.300	0.020	1.000	3.23	5.20	8.40
	0.300	1.000	0.250	3.29	5.00	8.93
	0.300	1.000	1.000	3.28	5.02	8.58
	1.000	0.020	0.250	3.16	5.42	9.07
	1.000	0.020	1.000	3.19	5.32	8.59
	1.000	1.000	0.250	3.25	5.12	9.21
	1.000	1.000	1.000	3.26	5.11	8.74
<b>230VAC</b>				<b>3.135--3.465</b>	<b>4.85--5.35</b>	<b>8.40--9.60</b>
	0.300	0.020	0.250	3.23	5.21	8.69
	0.300	0.020	1.000	3.23	5.20	8.39
	0.300	1.000	0.250	3.29	5.00	8.93
	0.300	1.000	1.000	3.28	5.01	8.58
	1.000	0.020	0.250	3.15	5.43	9.08
	1.000	0.020	1.000	3.19	5.32	8.58
	1.000	1.000	0.250	3.25	5.12	9.20
	1.000	1.000	1.000	3.26	5.11	8.74

Figure 10 – Cross Load Regulation, Room Temperature

### 9.3 Thermal Performance

The power supply was tested under the following conditions.

Vin (AC)	Load	Ambient Temperature (°C)
160	Full Load	75°
275	Full Load	75°

Figure 11 – Thermal Test Conditions

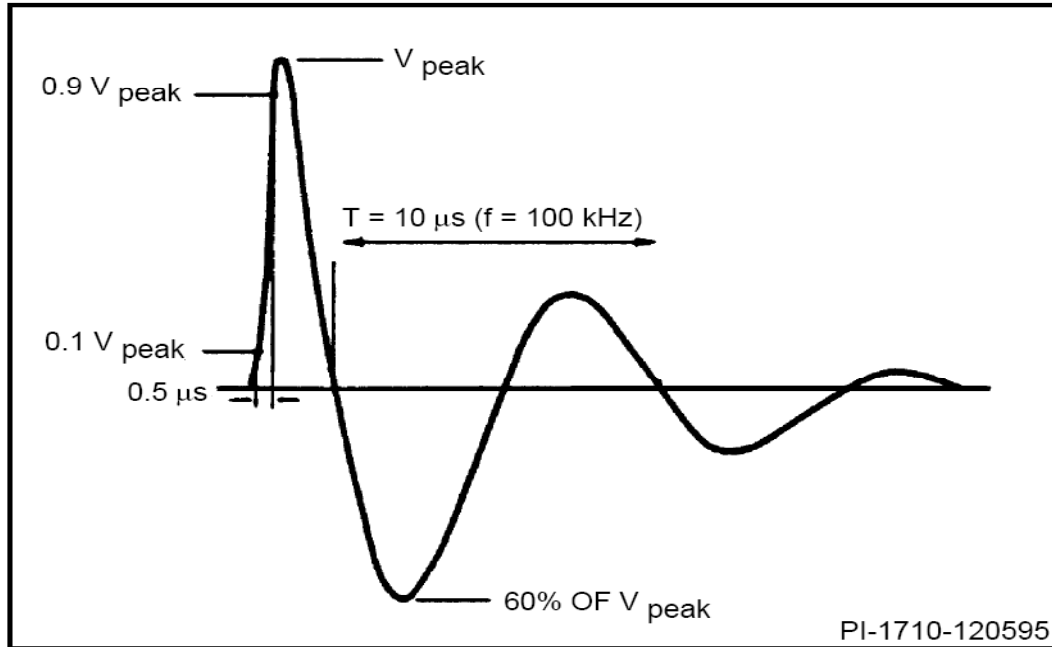
The supply operated for several hours at 75°C without going into thermal shut down. This implies very good margin against the max 65°C specification

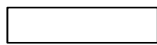


## 9.4 Surge test

### 9.4.1 Surge Test Setup

The unit was tested against spec IEEE-587. The figure below shows the waveform for the high voltage surge.



 *0.5 μs-100 kHz Ring Wave (Open-Circuit Voltage)  
From IEEE-587.*

**Figure 12 – Ring Waveform**

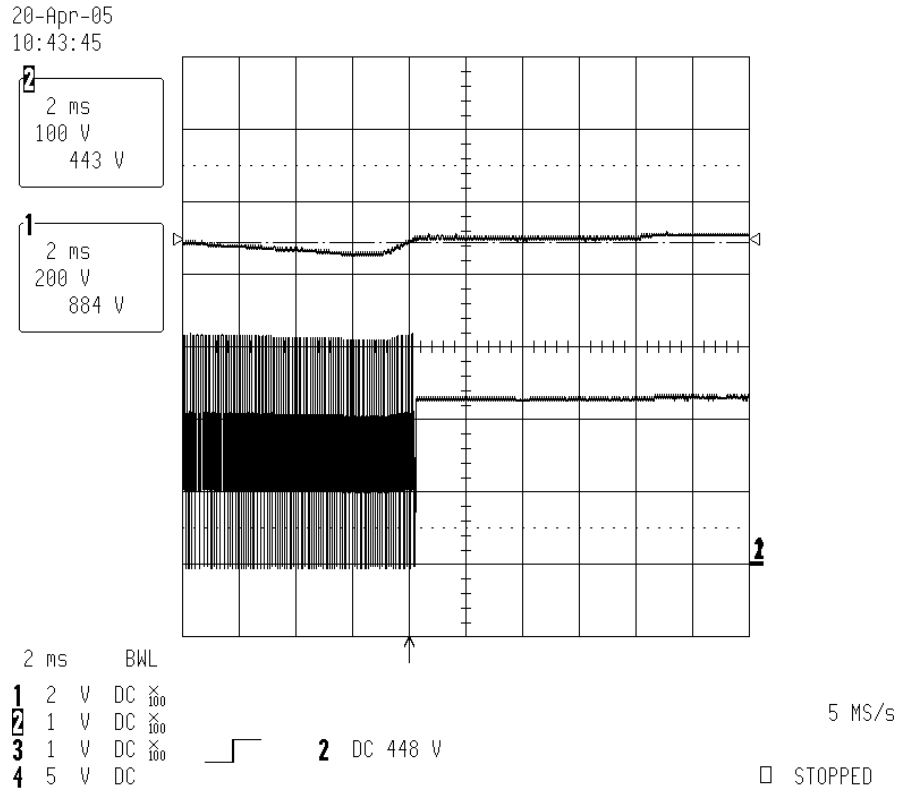
#### Test Conditions

V <sub>peak</sub> Test Voltage	6KV
Test Current	200A
Polarity	+/-
Phase	0,90,180,270
Test Mode	Differential Mode (L-N) and Common Mode (L1,N---GND).
Interval Between Tests	1 minute.

### 9.4.2 Surge Test Results.

The unit passes 6 KV in Both Differential and Common Mode

**9.5 AC Line Over Voltage (388 VAC swell)**

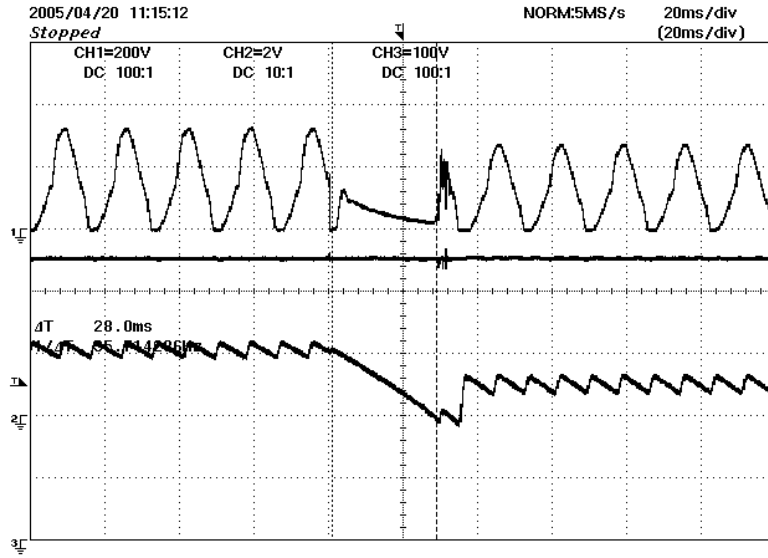


**Figure 13** – AC Line Over-voltage. Top Trace is the input bulk capacitor Voltage (100 V / Div). Bottom trace is the DRAIN Voltage (200 V / Div).

The AC Line voltage was slowly increased to 388 VAC. When this voltage reached 313 VAC (443 Vdc on bulk cap, top trace of above figure), the TOPSwitch shuts down and the supply stops running. When the AC Line is lowered to nominal voltage, the supply starts to run again. Just before the point of shutdown, the Drain voltage of the TOP244P reaches a maximum of 620 V, which is far below the max rating of 700 V.

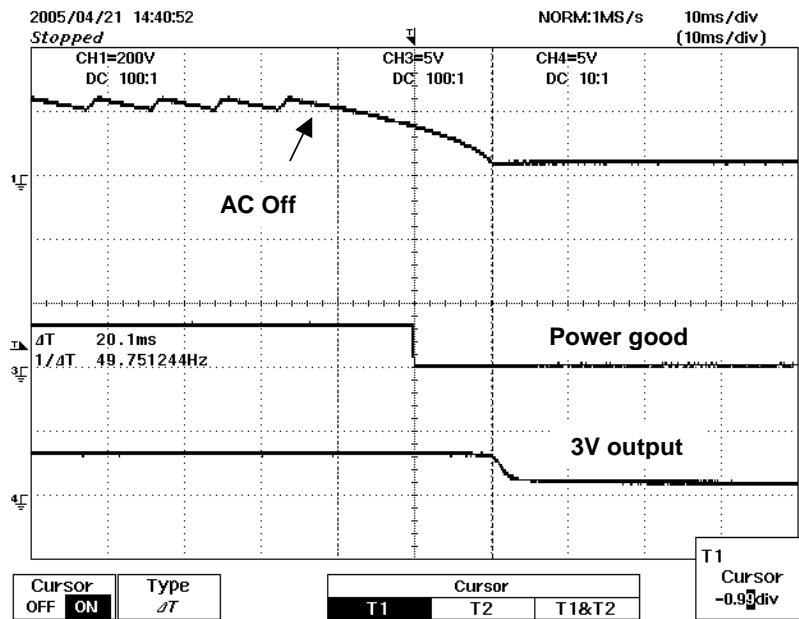


**9.6 Hold-Up Time and Power Good**



**Figure 14** – Hold-Up time. At Full Output Load. Top Trace is the AC Line Voltage, Middle trace 5V output, Bottom Trace is the HV DC bus. AC voltage is 160 Vac.

Note: The AC line was interrupted for about 28ms. The power supply maintained output regulation for the whole time the AC line was off.



**Figure 15** – 10mS/div. Holdup and power good. 160Vac, full load.

Notes:

- 3V output drops out >20 mS after AC turns off. (Spec is >16.7 mS)
- Power good goes down 10 mS before 3V (Spec is > 5mS)
- 160Vac is the worst case. Higher voltages show even greater holdup time.



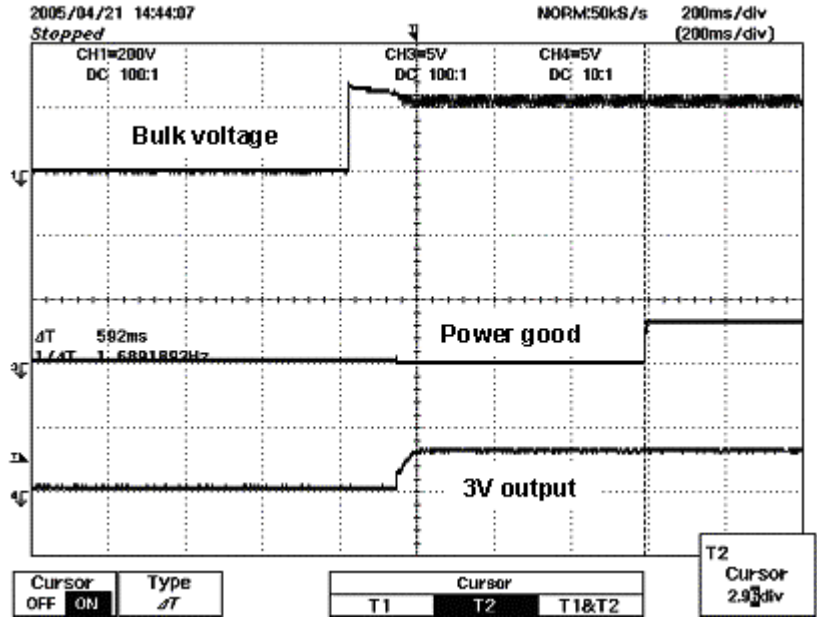


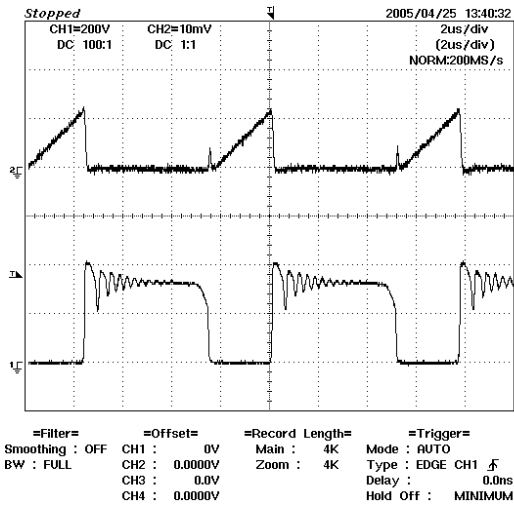
Figure 16 – Power up sequence of Powergood signal. 200 mS/div

Note: Power good comes up 600 mS after 3 V comes into regulation (Spec is >500 mS)

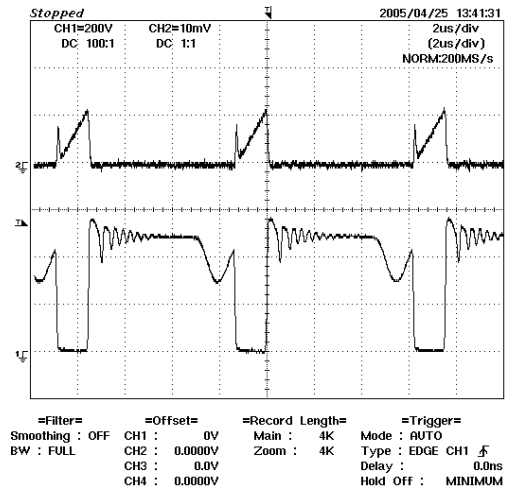


# 10 Waveforms

## 10.1 Drain Voltage and Current, Normal Operation

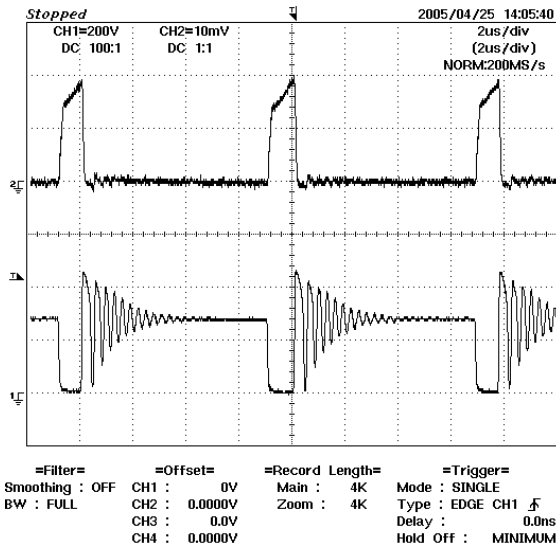


**Figure 17** – 160 VAC, Full Load  
 Upper:  $I_{DRAIN}$ , 0.5 A / div  
 Lower:  $V_{DRAIN}$ , 200 V, 2  $\mu$ s / div

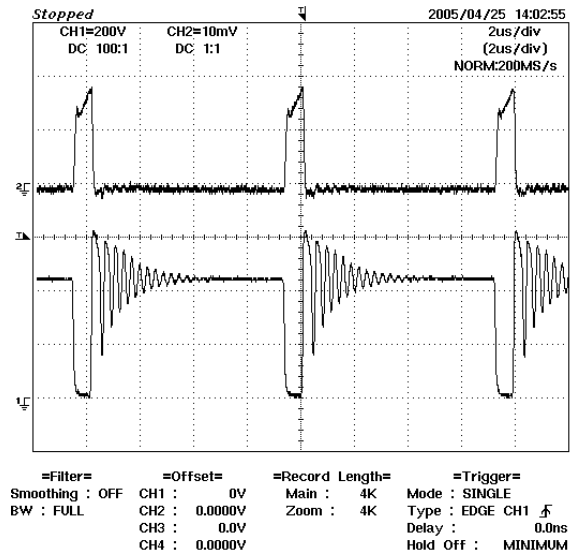


**Figure 18** – 275 VAC, Full Load  
 Upper:  $I_{DRAIN}$ , 0.5 A / div  
 Lower:  $V_{DRAIN}$ , 200 V / div

## 10.2 Drain Voltage and Current Start-up Profile



**Figure 19** – 160 VAC Input and Maximum Load.  
 Upper:  $I_{DRAIN}$ , 0.5 A / div.  
 Lower:  $V_{DRAIN}$ , 200 V & 2  $\mu$ s / div.



**Figure 20** – 275 VAC Input and Maximum Load.  
 Upper:  $I_{DRAIN}$ , 0.5 A / div.  
 Lower:  $V_{DRAIN}$ , 200 V & 2  $\mu$ s / div.

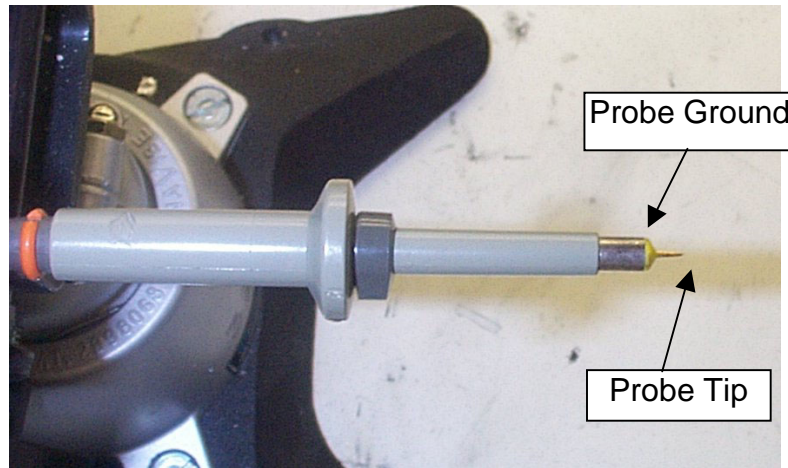


### 10.3 Output Ripple Measurements

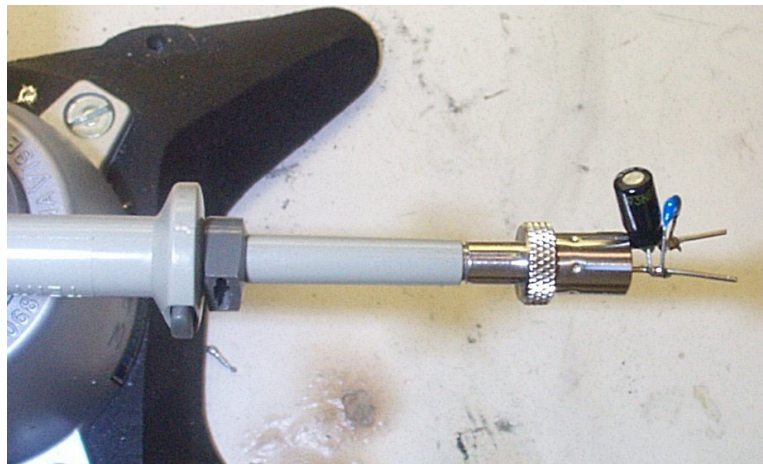
#### 10.3.1 Ripple Measurement Technique

For DC output ripple measurements, a modified oscilloscope test probe must be utilized in order to reduce spurious signals due to pickup

The 5125BA probe adapter is affixed with two capacitors tied in parallel across the probe tip. The capacitors include one (1) 0.1  $\mu\text{F}/50\text{ V}$  ceramic type and one (1) 1.0  $\mu\text{F}/50\text{ V}$  aluminum electrolytic. **The aluminum electrolytic type capacitor is polarized, so proper polarity across DC outputs must be maintained (see below).**



**Figure 21** – Oscilloscope Probe Prepared for Ripple Measurement. (End Cap and Ground Lead Removed)



**Figure 22** – Oscilloscope Probe with Probe Master 5125BA BNC Adapter. (Modified with wires for probe ground for ripple measurement, and two parallel decoupling capacitors added)



### 10.3.2 Measurement Results

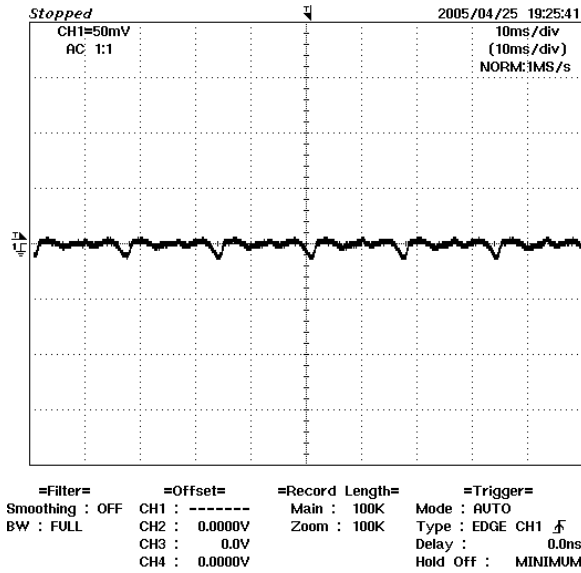


Figure 23 – 9 Voutput Ripple, 160 VAC, Full Load.  
10 ms, 50 mV / div

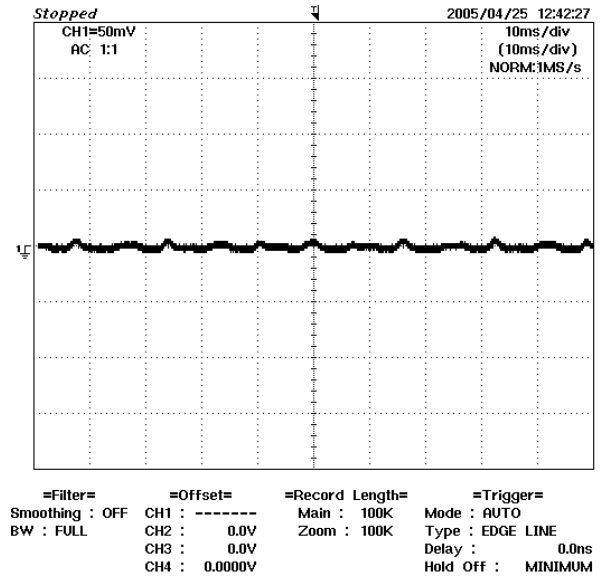


Figure 24 – 5 Voutput Ripple, 160 VAC, Full Load.  
10 ms, 50 mV / div

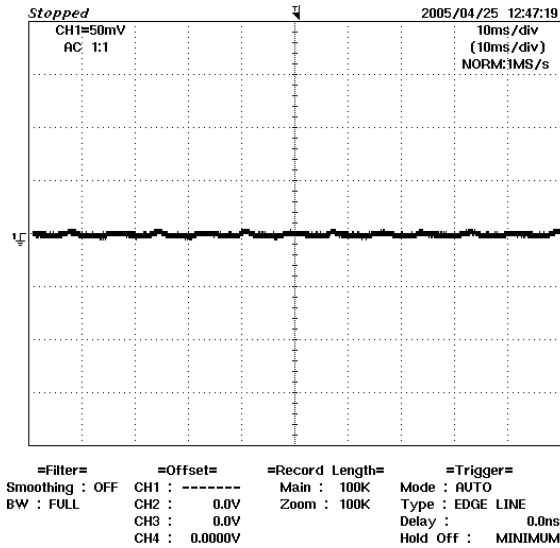
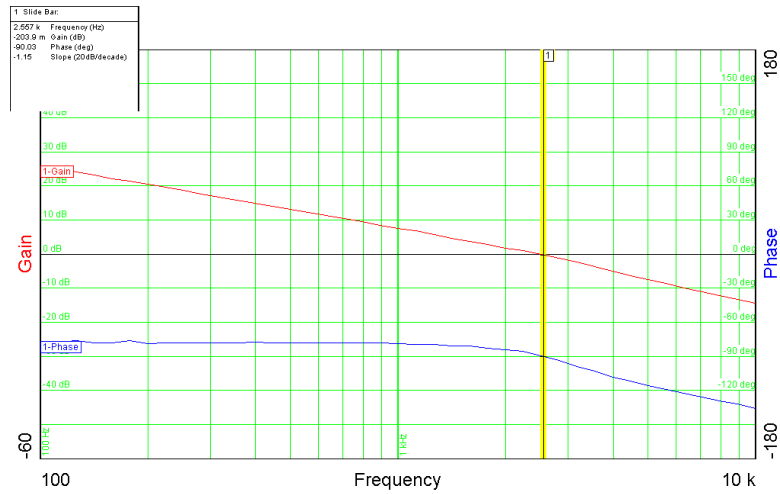


Figure 25 – 3.3 Voutput Ripple, 160 VAC, Full Load.  
10 ms, 50 mV / div

## 11 Control Loop Measurements

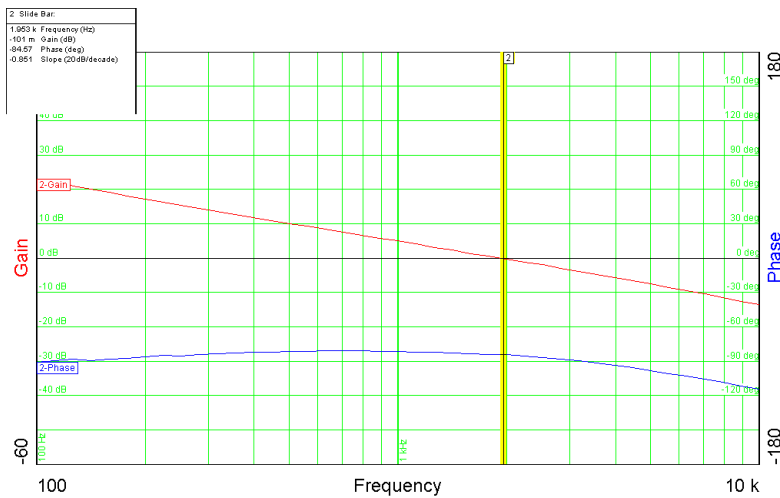
These results show phase margin > 60°

### 11.1 160 VAC Maximum Load



**Figure 26** – Gain-Phase Plot, 160 VAC, Maximum Steady State Load  
 Vertical Scale: Gain = 10 dB/div, Phase = 30 °/div.  
 Crossover Frequency = 2.557 kHz Phase Margin = 89°

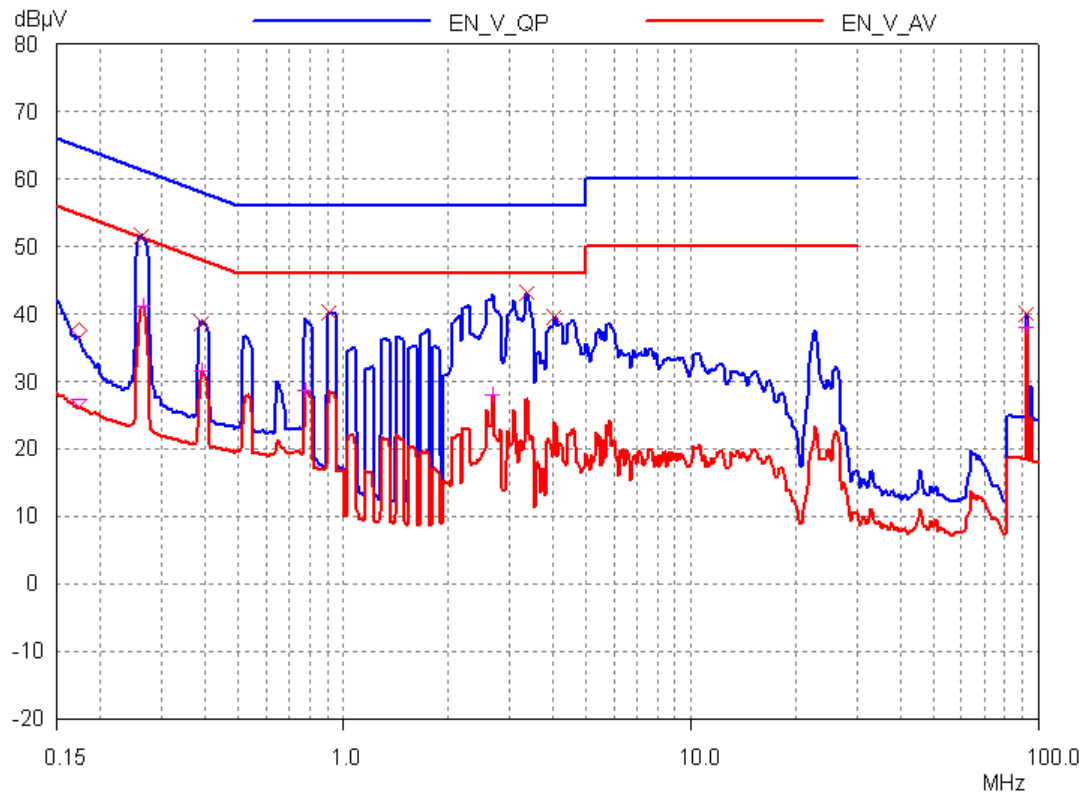
### 11.2 230 VAC Maximum Load



**Figure 27** – Gain-Phase Plot, 230 VAC, Maximum Steady State Load  
 Vertical Scale: Gain = 10 dB/div, Phase = 30 °/div.  
 Crossover Frequency = 1.953 Hz, Phase Margin = 95°



## 12 Conducted EMI



**Figure 28** – Conducted EMI, Maximum Steady State Load, 230 VAC, 60 Hz, and EN55022 B Limits. Supply is at full load. OUTPUT RETURN connector to Chassis Ground



### 13 Revision History

<b>Date</b>	<b>Author</b>	<b>Revision</b>	<b>Description &amp; changes</b>	<b>Reviewed</b>
September 12, 2005	VC	1.0	First Release	VC / AM



For the latest updates, visit our Web site: [www.powerint.com](http://www.powerint.com)

Power Integrations may make changes to its products at any time. Power Integrations has no liability arising from your use of any information, device or circuit described herein nor does it convey any license under its patent rights or the rights of others. POWER INTEGRATIONS MAKES NO WARRANTIES HEREIN AND SPECIFICALLY DISCLAIMS ALL WARRANTIES INCLUDING, WITHOUT LIMITATION, THE IMPLIED WARRANTIES OF MERCHANTABILITY, FITNESS FOR A PARTICULAR PURPOSE, AND NON-INFRINGEMENT OF THIRD PARTY RIGHTS.

#### PATENT INFORMATION

The products and applications illustrated herein (including circuits external to the products and transformer construction) may be covered by one or more U.S. and foreign patents or potentially by pending U.S. and foreign patent applications assigned to Power Integrations. A complete list of Power Integrations' patents may be found at [www.powerint.com](http://www.powerint.com).

The PI Logo, **TOPSwitch**, **TinySwitch**, **LinkSwitch**, and **EcoSmart** are registered trademarks of Power Integrations. **PI Expert** and **DPA-Switch** are trademarks of Power Integrations.

© Copyright 2004, Power Integrations.

### Power Integrations Worldwide Sales Support Locations

#### WORLD HEADQUARTERS

5245 Hellyer Avenue,  
San Jose, CA 95138, USA  
Main: +1-408-414-9200  
Customer Service:  
Phone: +1-408-414-9665  
Fax: +1-408-414-9765  
*e-mail:*  
[usasales@powerint.com](mailto:usasales@powerint.com)

#### CHINA (SHANGHAI)

Rm 807, Pacheer,  
Commercial Centre,  
555 Nanjing West Road,  
Shanghai, 200041, China  
Phone: +86-21-6215-5548  
Fax: +86-21-6215-2468  
*e-mail:*  
[chinasales@powerint.com](mailto:chinasales@powerint.com)

#### CHINA (SHENZHEN)

Rm# 1705, Bao Hua Bldg.  
1016 Hua Qiang Bei Lu,  
Shenzhen, Guangdong,  
518031, China  
Phone: +86-755-8367-5143  
Fax: +86-755-8377-9610  
*e-mail:*  
[chinasales@powerint.com](mailto:chinasales@powerint.com)

#### APPLICATIONS HOTLINE

World Wide +1-408-414-9660  
ER or EPR template – Rev 3.6 – Single sided

#### GERMANY

Rueckertstrasse 3,  
D-80336, Munich, Germany  
Phone: +49-895-527-3910  
Fax: +49-895-527-3920  
*e-mail:* [eurosales@powerint.com](mailto:eurosales@powerint.com)

#### INDIA (TECHNICAL SUPPORT)

Innovatech  
261/A, Ground Floor  
7th Main, 17th Cross,  
Sadashivanagar  
Bangalore, India, 560080  
Phone: +91-80-5113-8020  
Fax: +91-80-5113-8023  
*e-mail:* [indiasales@powerint.com](mailto:indiasales@powerint.com)

#### ITALY

Via Vittorio Veneto 12, Bresso,  
Milano,  
20091, Italy  
Phone: +39-028-928-6001  
Fax: +39-028-928-6009  
*e-mail:* [eurosales@powerint.com](mailto:eurosales@powerint.com)

#### APPLICATIONS FAX

World Wide +1-408-414-9760

#### JAPAN

Keihin-Tatemono 1st Bldg.  
12-20 Shin-Yokohama,  
2-Chome,  
Kohoku-ku, Yokohama-shi,  
Kanagawa 222-0033, Japan  
Phone: +81-45-471-1021  
Fax: +81-45-471-3717  
*e-mail:*  
[japansales@powerint.com](mailto:japansales@powerint.com)

#### KOREA

8th Floor, DongSung Bldg.  
17-8 Yoido-dong,  
Youngdeungpo-gu,  
Seoul, 150-874, Korea  
Phone: +82-2-782-2840  
Fax: +82-2-782-4427  
*e-mail:*  
[koreasales@powerint.com](mailto:koreasales@powerint.com)

#### SINGAPORE

51 Newton Road,  
#15-08/10 Goldhill Plaza,  
Singapore, 308900  
Phone: +65-6358-2160  
Fax: +65-6358-2015  
*e-mail:*  
[singaporesales@powerint.com](mailto:singaporesales@powerint.com)

#### TAIWAN

17F-3, No. 510,  
Chung Hsiao E. Rd., Sec. 5,  
Taipei, Taiwan 110, R.O.C.  
Phone: +886-2-2727-1221  
Fax: +886-2-2727-1223  
*e-mail:*  
[taiwansales@powerint.com](mailto:taiwansales@powerint.com)

#### UK (EUROPE & AFRICA HEADQUARTERS)

1st Floor, St. James's House  
East Street  
Farnham, Surrey GU9 7TJ  
United Kingdom  
Phone: +44-1252-730-140  
Fax: +44-1252-727-689  
*e-mail:* [eurosales@powerint.com](mailto:eurosales@powerint.com)

