

■ Dimensions

Note: All units are in millimeters unless otherwise indicated.

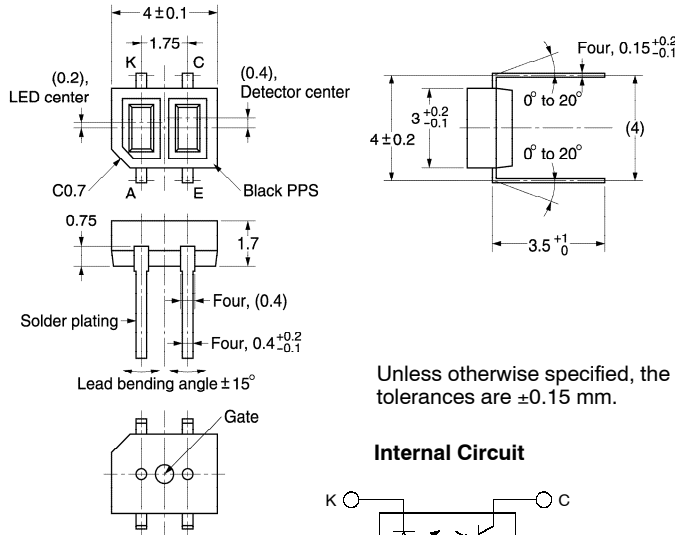

Unless otherwise specified, the tolerances are ±0.15 mm.

Internal Circuit

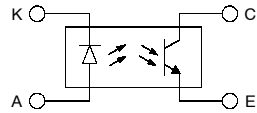

Terminal No.	Name
A	Anode
K	Cathode
C	Collector
E	Emitter

■ Features

- Ultra-compact model with 1 mm sensing distance.

■ Absolute Maximum Ratings (Ta = 25°C)

Item		Symbol	Rated value
Emitter	Forward current	I_F	50 mA (see note 1)
	Pulse forward current	I_{FP}	1 A (see note 2)
	Reverse voltage	V_R	4 V
Detector	Collector-Emitter voltage	V_{CEO}	30 V
	Emitter-Collector voltage	V_{ECO}	5 V
	Collector current	I_C	20 mA
	Collector dissipation	P_C	75 mW (see note 1)
Ambient temperature	Operating	T_{opr}	-25°C to 85°C
	Storage	T_{stg}	-40°C to 100°C
Soldering temperature		T_{sol}	260°C (see note 3)

- Note:**
1. Refer to the temperature rating chart if the ambient temperature exceeds 25°C.
 2. The pulse width is 10 μs maximum with a frequency of 100 Hz.
 3. Complete soldering within 10 seconds.

■ Ordering Information

Description	Part number
Photomicrosensor (Reflective)	EE-SY124

■ Electrical and Optical Characteristics (Ta = 25°C)

Item	Symbol	Value	Condition
Emitter	Forward voltage	V_F	1.2 V typ., 1.4 V max. $I_F = 20$ mA
	Reverse current	I_R	0.01 μA typ., 10 μA max. $V_R = 4$ V
	Peak emission wavelength	λ_P	950 nm typ. $I_F = 4$ mA
Detector	Light current	I_L	50 μA min., 300 μA max. $I_F = 4$ mA, $V_{CE} = 2$ V Aluminum-deposited surface, d = 1 mm (see note)
	Dark current	I_D	2 nA typ., 200 nA max. $V_{CE} = 10$ V, 0 lx
	Leakage current	I_{LEAK}	200 nA max. $I_F = 4$ mA, $V_{CE} = 2$ V with no reflection
	Collector-Emitter saturated voltage	$V_{CE (sat)}$	---
	Peak spectral sensitivity wavelength	λ_P	930 nm typ. $V_{CE} = 10$ V
Rising time	t_r	35 μs typ. $V_{CC} = 2$ V, $R_L = 1$ kΩ, $I_L = 100$ μA	
Falling time	t_f	25 μs typ. $V_{CC} = 2$ V, $R_L = 1$ kΩ, $I_L = 100$ μA	

Note: The letter "d" indicates the distance between the top surface of the sensor and the sensing object.

■ Engineering Data

Forward Current vs. Collector Dissipation Temperature Rating

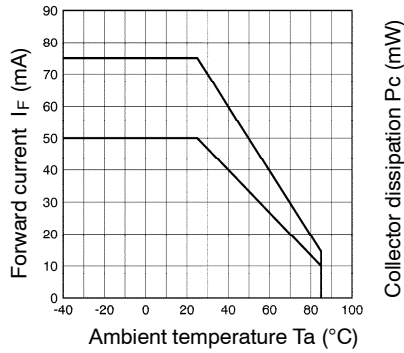

Light Current vs. Forward Current Characteristics (Typical)

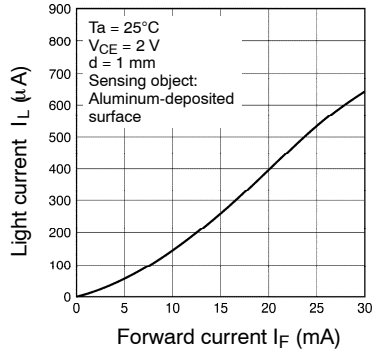

Light Current vs. Collector-Emitter Voltage Characteristics (Typical)

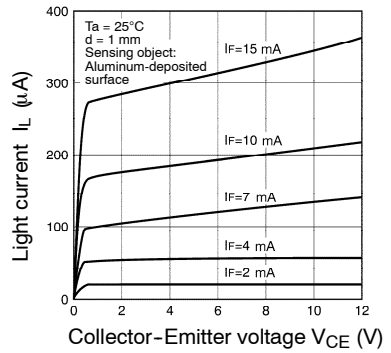

Relative Light Current vs. Ambient Temperature Characteristics (Typical)

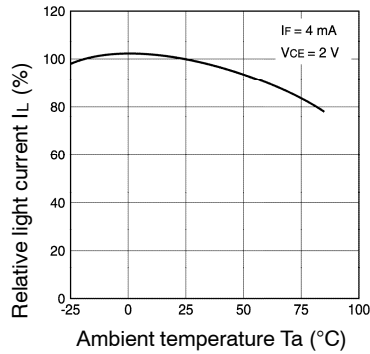

Dark Current vs. Ambient Temperature Characteristics (Typical)

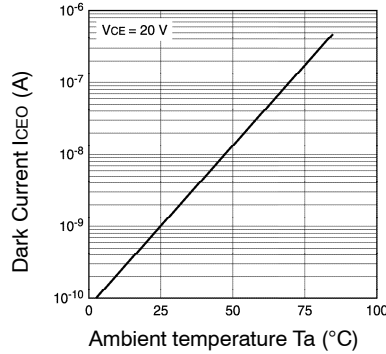

Response Time vs. Load Resistance Characteristics (Typical)

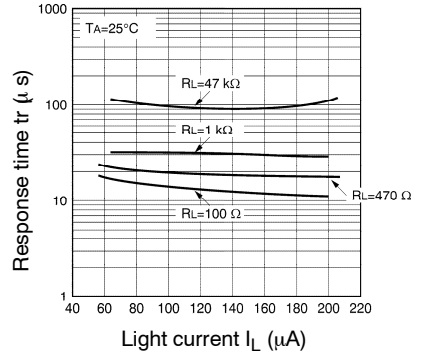

Response Time vs. Load Resistance Characteristics (Typical)

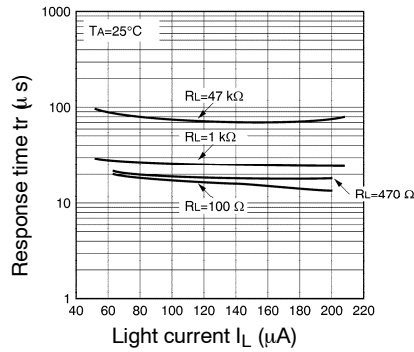

Sensing Distance Characteristics (Typical)

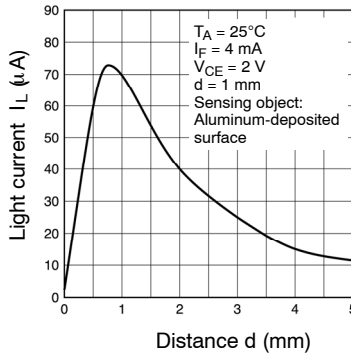

Relative Light Current vs. Card Moving Distance (1)

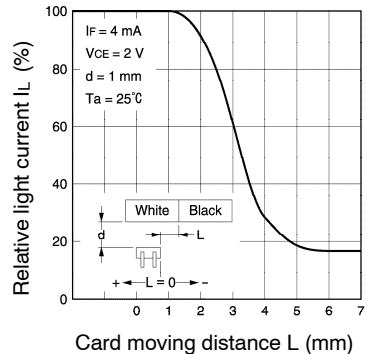

Relative Collector Current vs. Card Moving Distance (2)

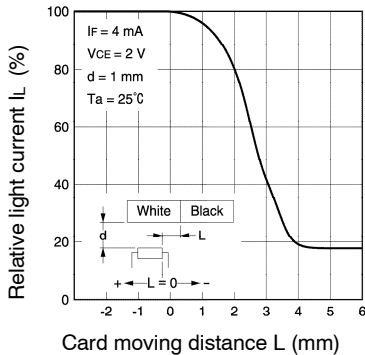

Response Time Measurement Circuit

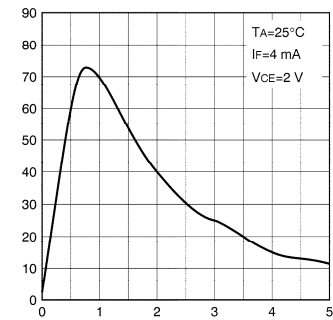
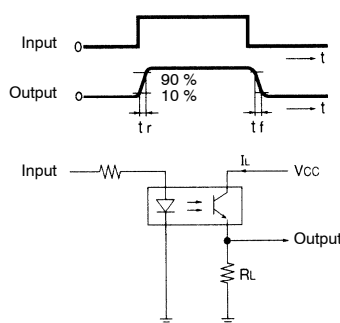

NOTE: DIMENSIONS SHOWN ARE IN MILLIMETERS. To convert millimeters to inches divide by 25.4.

OMRON[®]

OMRON ELECTRONICS LLC

One East Commerce Drive
Schaumburg, IL 60173

847-882-2288

OMRON CANADA, INC.

885 Milner Avenue
Toronto, Ontario M1B 5V8

416-286-6465

OMRON ON-LINE

Global – <http://www.omron.com>

USA – <http://www.omron.com/oei>

Canada – <http://www.omron.com/oci>