

# Photomicrosensor (Reflective) EE-SY201

## ■ Dimensions

Note: All units are in millimeters unless otherwise indicated.

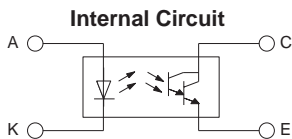
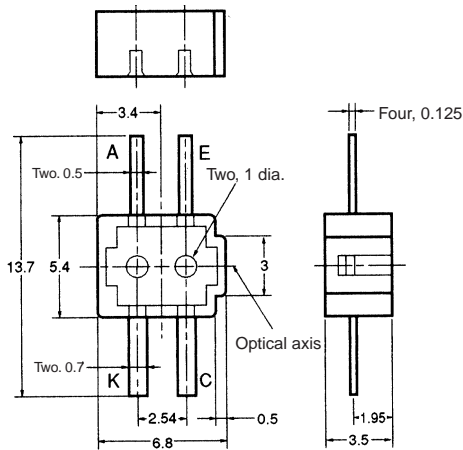

Unless otherwise specified, the tolerances are as shown below.

Dimensions	Tolerance
3 mm max.	±0.3
3 < mm ≤ 6	±0.375
6 < mm ≤ 10	±0.45
10 < mm ≤ 18	±0.55
18 < mm ≤ 30	±0.65

Terminal No.	Name
A	Anode
K	Cathode
C	Collector
E	Emitter

## ■ Features

- The LED requires a forward current of only 5 mA due to the Photo-Darlington transistor built into the detector.
- With a red LED light source.

## ■ Absolute Maximum Ratings (Ta = 25°C)

Item	Symbol	Rated value
Emitter	Forward current	$I_F$ 15 mA (see note 1)
	Pulse forward current	$I_{FP}$ ---
	Reverse voltage	$V_R$ 4 V
Detector	Collector–Emitter voltage	$V_{CEO}$ 24 V
	Emitter–Collector voltage	$V_{ECO}$ ---
	Collector current	$I_C$ 20 mA
	Collector dissipation	$P_C$ 50 mW (see note 1)
Ambient temperature	Operating	$T_{opr}$ -20°C to 60°C
	Storage	$T_{stg}$ -20°C to 80°C
Soldering temperature	$T_{sol}$	260°C (see note 2)

- Note: 1. Refer to the temperature rating chart if the ambient temperature exceeds 25°C.  
2. Complete soldering within 10 seconds.

## ■ Electrical and Optical Characteristics (Ta = 25°C)

Item	Symbol	Value	Condition
Emitter	Forward voltage	$V_F$ 2.0 V typ., 2.6 V max.	$I_F = 15$ mA
	Reverse current	$I_R$ 0.01 $\mu$ A typ., 5 $\mu$ A max.	$V_R = 4$ V
	Peak emission wavelength	$\lambda_P$ 700 nm typ.	$I_F = 10$ mA
Detector	Light current	$I_L$ 0.3 $\mu$ A min., 8.0 $\mu$ A max.	$I_F = 5$ mA, $V_{CE} = 10$ V White paper with a reflection ratio of 90%, $d = 4$ mm (see note)
	Dark current	$I_D$ 2 nA typ., 250 nA max.	$V_{CE} = 10$ V, 0 lx
	Leakage current	$I_{LEAK}$ ---	---
	Collector–Emitter saturated voltage	$V_{CE(sat)}$ ---	---
	Peak spectral sensitivity wavelength	$\lambda_P$ 750 nm typ.	$V_{CE} = 10$ V
Rising time	$t_r$ 180 $\mu$ s typ.	$V_{CC} = 5$ V, $R_L = 100 \Omega$ , $I_L = 1$ mA	
Falling time	$t_f$ 60 $\mu$ s typ.	$V_{CC} = 5$ V, $R_L = 100 \Omega$ , $I_L = 1$ mA	

Note: The letter “d” indicates the distance between the top surface of the sensor and the sensing object.

■ Engineering Data

**Forward Current vs. Collector Dissipation Temperature Rating**

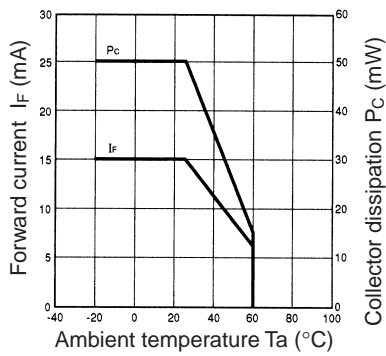

**Light Current vs. Forward Current Characteristics (Typical)**

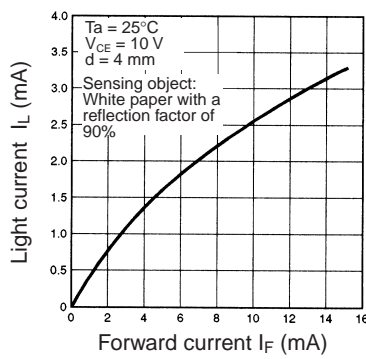

**Light Current vs. Collector-Emitter Voltage Characteristics (Typical)**

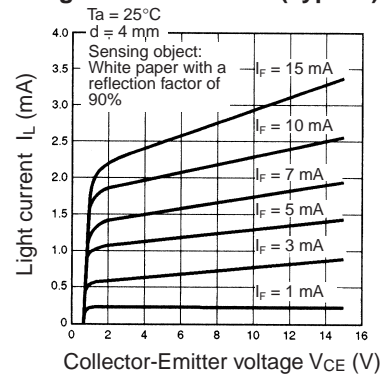

**Relative Light Current vs. Ambient Temperature Characteristics (Typical)**

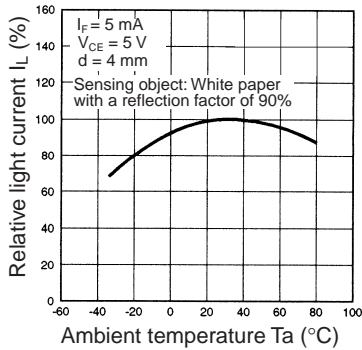

**Dark Current vs. Ambient Temperature Characteristics (Typical)**

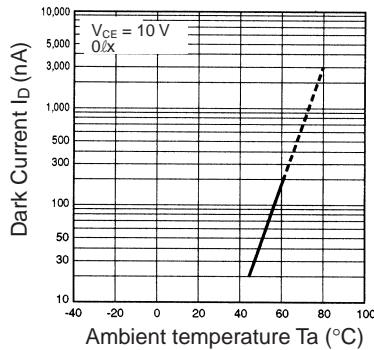

**Response Time vs. Load Resistance Characteristics (Typical)**

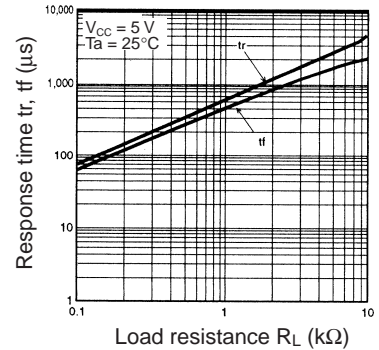

**Sensing Distance Characteristics (Typical)**

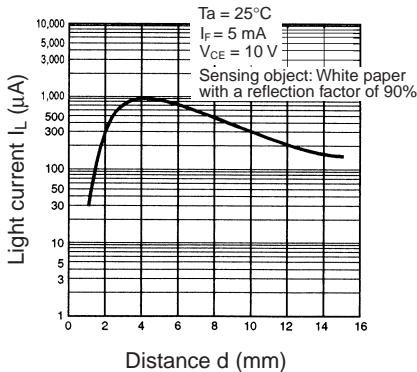

**Sensing Position Characteristics (Typical)**

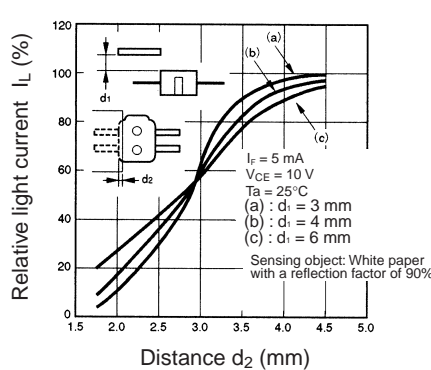

**Sensing Angle Characteristics (Typical)**

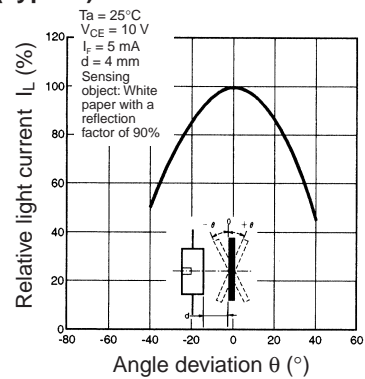

**Response Time Measurement Circuit**

