

<b>Title</b>	<b>Engineering Prototype Report for EP-18 10 W, Multiple Output, Isolated Power Supply with TOPSwitch<sup>®</sup>-GX</b>	
<b>Key Specifications</b>	<b>Input Voltage</b>	<b>85-265 VAC</b>
	<b>Output Voltages and Current</b>	<b>3.3 V, 1.5 A</b>
		<b>5 V, 0.9 A</b>
		<b>30 V, 0.03 A</b>
	<b>Output Power</b>	<b>10 W</b>
	<b>Efficiency</b>	<b>70% minimum</b>
<b>P.I. Device</b>	<b>TOP243P (TOPSwitch-GX)</b>	
<b>Target Applications</b>	High Speed Digital Modems / Telecom	
<b>Document Number</b>	EPR-18	
<b>Date</b>	05-Dec-2002	
<b>Revision</b>	1.3	

### Features

- Low cost (low component count with single sided printed circuit board)
- Low conducted EMI: meets CISPR22B/EN55022B without requiring a Y capacitor
- Meets EN/UL 1000-4-5 CLASS 4 (4 kV), using line overvoltage protection feature
- Designed to IEC60950 safety standard requirements
- Ultra-low earth leakage current (<1  $\mu$ A @ 265 VAC, 50/60 Hz) eliminates line frequency audio hum in voice applications ("ground loops")
- Compact Design (L = 113 mm, W = 39 mm, H = 25 mm)
- High efficiency ( $\geq$ 70% at 85 VAC)
- Line undervoltage shutdown prevents turn-off output glitches
- Line overvoltage shutdown provides extended line swell protection
- Hysteretic thermal shutdown provides automatic supply recovery after fault removal

## Table Of Contents

1	Introduction.....	3
2	Power Supply Specification .....	4
3	Schematic.....	5
4	Circuit Description .....	6
5	PCB Layout .....	9
6	Bill Of Materials .....	10
7	Transformer Specification.....	11
7.1	Electrical Specifications.....	11
7.2	Materials.....	11
7.3	Transformer Build Diagram .....	12
7.4	Transformer Construction.....	12
7.5	Design Notes.....	13
7.6	Transformer Sources.....	13
8	Transformer Spreadsheets.....	15
9	Performance Data .....	17
9.1	Efficiency.....	17
9.2	Regulation .....	18
9.2.1	Load .....	18
9.2.2	Line .....	18
9.2.3	Cross-Regulation Table.....	19
10	Thermal Performance .....	20
11	Waveform Scope Plots .....	21
12	Load Transient Response (75% to 100% Load Step).....	22
13	Conducted EMI .....	23
14	Surge Voltage .....	25
14.1	Differential = Line-to-Line (L-N), 2 $\Omega$ Source Impedance. ....	25
14.2	Common Mode = Line-to-Ground (L-GND, N-GND), 12 $\Omega$ Source Impedance. ....	25
15	Revision History .....	26

### Important Note:

Although the EP-18 is designed to satisfy safety isolation requirements, the engineering prototype has not been agency approved. Therefore, all testing should be performed using an isolation transformer to provide the AC input to the prototype board.



## 1 Introduction

This document is an engineering report describing a low cost, isolated converter (EP-18) for a High Speed Digital Modem application.

Included are the power supply specification, schematic, bill of materials, transformer documentation, printed circuit layout, and performance data.

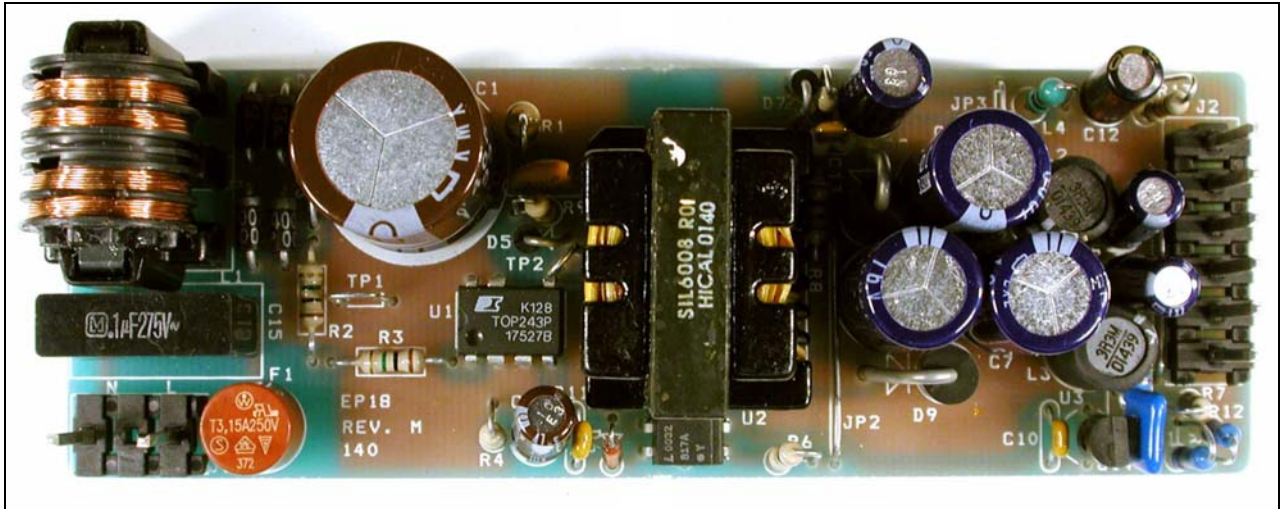


Figure 1 – EP-18 Populated Circuit Board (LxWxH: 113 mm x 39 mm x 25mm).

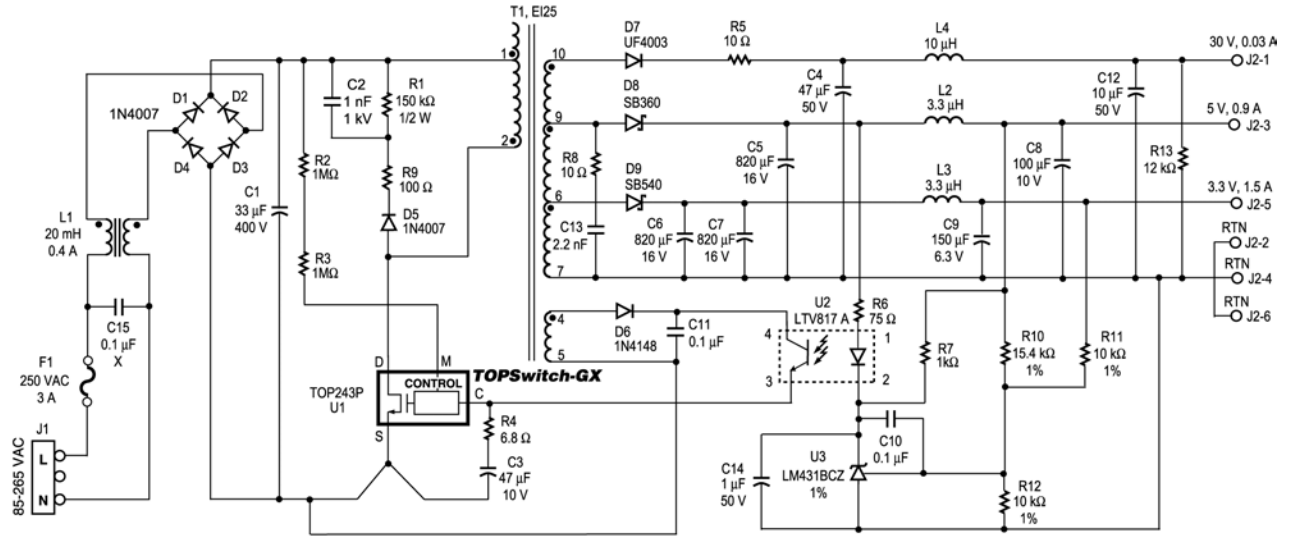
## 2 Power Supply Specification

Description	Symbol	Min	Typ	Max	Units	Comment
<b>Input</b> Voltage	$V_{IN}$	85		265	VAC	50/60 Hz
<b>Output</b> Output Voltage 1	$V_{OUT1}$	3.13	3.30	3.47	V	±5% Total Peak to Peak, 20 MHz BW
Output Ripple Voltage 1	$V_{RIPPLE1}$			30	mV	
Output Current 1	$I_{OUT1}$	0.3	1.5	3.00	A	
Output Voltage 2	$V_{OUT2}$	4.75	5.00	5.25	VDC	±5% Total Peak to Peak, 20 MHz BW
Output Ripple Voltage 2	$V_{RIPPLE2}$			50	mV	
Output Current 2	$I_{OUT2}$	0.3	0.9		A	
Output Voltage 3	$V_{OUT3}$		30		VDC	±10% Total Peak to Peak, 20 MHz BW
Output Ripple Voltage 3	$V_{RIPPLE3}$			150	mV	
Output Current 3	$I_{OUT3}$	0.01	0.03		A	
<b>Total Output Power</b> Continuous Output Power	$P_{OUT}$			10	W	Full Load
<b>Efficiency</b>	$\eta$	70			%	Full Load, 25 °C, $V_{IN(MIN)}$
<b>Environmental</b> Surge (differential, 2 $\Omega$ )	Line-Line	2			kV	IEC/UL 1000-4-5 Class 4
Surge (common mode, 12 $\Omega$ )	Line/Line-PE	4			kV	IEC/UL 1000-4-5 Class 4
Ambient Temperature	$T_{AMB\_EXT}$	0	25	50	°C	External Ambient Range
Internal Ambient Temperature	$T_{AMB\_INT}$			70	°C	Internal Case Ambient Range
Conducted EMI*	Meets CISPR22B with secondary connected to protective earth ground (PE) (worst case condition)					
Safety	Designed to exceed IEC60950 requirements					

\*Conducted EMI is met without a safety rated Y class capacitor bridging primary and secondary. This provides an ultra-low earth leakage current (<1 $\mu$ A at 265 VAC, 50/60 Hz) necessary to eliminate line frequency audio hum in voice applications (“ground loops”).



### 3 Schematic



PI-3421-120602

Figure 2 - EP-18 Schematic.



## 4 Circuit Description

The EP-18 is a low-cost flyback switching power supply designed for high speed digital modem applications using the TOP243P integrated circuit. It offers a low cost solution with emphasis on low EMI and ultra-low earth leakage current (no Y cap).

The circuit schematic details a 10 W, 3 output (3.3 VDC, 5 VDC and 30 VDC) power supply that operates from an 85 VAC to 265 VAC input. The high efficiency (>70%) allows the power supply to operate within specifications at elevated ambient temperature.

The AC input is rectified and filtered by D1 to D4 and C1 to create a high voltage DC bus that is connected to transformer T1. The other side of T1 is driven by the high-voltage MOSFET of TOP243P<sup>1</sup> (U1). Fuse F1 protects against primary-side components failures, while U1 protects against secondary components failures, and overloaded/shorted outputs.

The combined value of the line sensing resistors R2 and R3, connected to the MULTI-FUNCTION (M) pin of U1, sets the undervoltage and overvoltage thresholds and provides a line feed forward function.

On increasing line voltage, the power supply is inhibited until the undervoltage (UV) threshold is reached (~100 VDC). On reducing line voltage, the UV function turns off the power supply when the line input voltage is below the UV threshold and the output goes out of regulation. This allows the power supply to continue operating at input voltages significantly below the UV threshold until output regulation is lost, but eliminates output glitches by preventing restart until the input voltage goes back above the UV threshold.

The overvoltage function turns off the power supply if the input voltage exceeds approximately 450 V. In the off-state, the power supply can withstand severe line transients or extended line swell conditions without damage. The supply resumes operation when the input voltage falls below the overvoltage threshold.

The line feed forward function independently modulates the duty cycle of U1 to reject the AC line frequency ripple component of the input voltage, reducing the line frequency ripple at the output of the supply. The output ripple specifications can be met without increased control loop gain since line feed forward operates independent of the main control loop. This simplifies the design of the power supply control loop.

A low cost RCD (R1, C2, R9 and D5) snubber circuit limits the turn-off voltage spike (caused by the leakage inductance) to a safe level on the DRAIN pin of U1. Resistor R9 is required in series with the slow recovery diode (D5) to reduce the diode reverse

---

<sup>1</sup> The "P" and "G" packages allow either line sensing or external current limit programming through the M pin. "Y" and "R" packages allow both functions via the L and X pins. Reducing the current limit in this design would allow a smaller transformer to be used, if desired.



recovery spike and damp the subsequent oscillations which might allow the drain to ring below source at low line.

The bias winding is rectified and filtered by D6 and C11 to power U1. Capacitor C3 is used to decouple the CONTROL pin, determine the auto-restart frequency and together with R4, forms part of the control loop compensation.

The secondary winding is rectified and filtered by D7, R5, C4 (30 V) D8, C5 (5 V) and D9, C7, C8 (3.3 V), with additional switching frequency ripple and high frequency spike noise filtering provided by L2, C8 (5 V) and L3, C9 (3.3 V) to give the DC outputs.

The choice of Schottky diodes for the 3.3 V and 5 V outputs was driven by both voltage regulation and efficiency considerations. Resistor R5 limits the diode current at start-up and avoids peak charging of the 30 V output. If a fusible resistor is used, R5 can provide short circuit protection for this output.

The snubber (C13 and R8) reduces the 10 MHz to 30 MHz conducted EMI due secondary leakage inductance. The current through the pre-load resistor R13 adds to the spec minimum load to keep the 30 V output in regulation. The 3.3 V and 5 V output voltages are determined by the voltage set at the adjust pin of U3 (shunt regulator) by the voltage divider formed by R10, R11 and R12. The current through R12 (250  $\mu$ A) sets the output voltages, while the current contribution of R10 and R11 (250  $\mu$ A total) sets the regulation band for 3.3 V and 5 V outputs, respectively. Other output voltages are possible by adjusting the transformer turns ratios, choosing the output diodes forward voltage drops and voltage divider settings. Optocoupler U2 applies the feedback signal from U3 to the CONTROL pin of U1. Resistor R6 is used to set the overall gain of the supply control loop, while R7 provides bias current for U3. Capacitor C10 provides frequency compensation for U3 stabilizing the power supply control loop. Capacitor C14 is used to close the feedback loop (bypassing U3) through optocoupler U2 during start-up, before U3 takes over the control loop. The ability to close the feedback loop in conjunction with the built-in soft-start feature of *TOPSwitch-GX* completely controls the start-up drain current profile, preventing transformer saturation and output overshoot.

The 3.3 V and 5 V secondary layout switching loops are minimized and, along with closely coupled transformer secondary windings, achieve low secondary leakage inductance and in turn, good cross-regulation. Optimizing the number of primary turns minimizes leakage. This also reduces the number of primary layers and improves primary to secondary coupling.

The power supply meets IEC60950/UL1950 safety requirements. Primary-to-secondary isolation is assured by using parts/materials (opto/transformer insulation) with the correct level of isolation and creepage distances (opto slot/transformer bobbin).

The power supply passed IEC/UL 1000-4-5, Class 4 line surge test (Class 3 only is required). All three outputs had monitor LEDs that showed no output disruption during the 90 high voltage surge pulses of Class 3. During Class 4 testing the outputs were



disrupted for one second (LEDs blinked indicating the operation of the overvoltage shutdown feature) when applying the 2 kV, 2  $\Omega$  differential pulse and the 4 kV, 2  $\Omega$  differential pulses (L1/GND, L2/GND) and were unaffected during the 4 kV, 12  $\Omega$  common-mode pulses (L1, L2/GND).

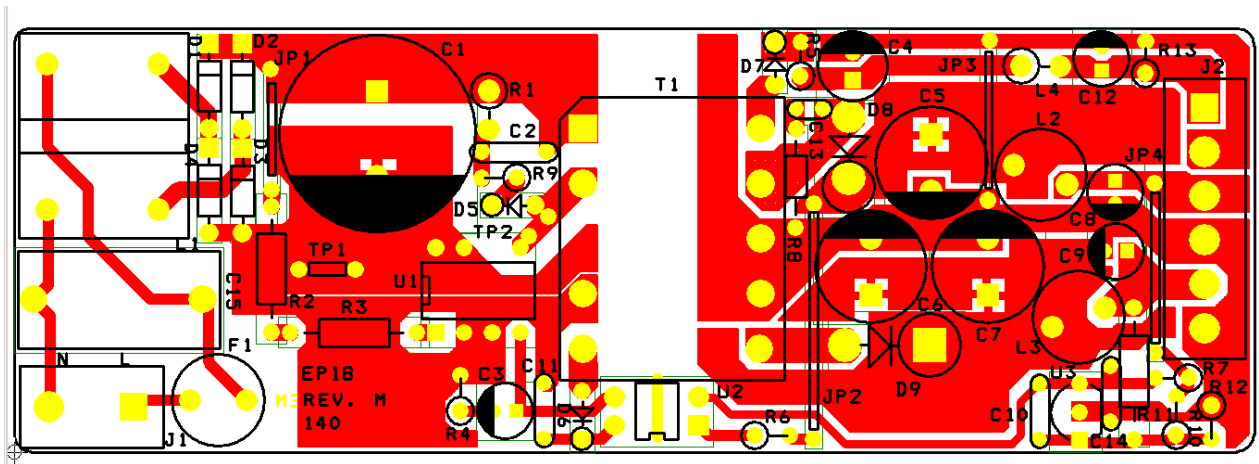
The switching frequency jitter of TOP243 (U1) allows the unit to meet worldwide conducted EMI standards using a low cost, common-mode inductor (L1) in combination with a small value capacitor (C15). Careful transformer construction and PCB layout eliminate the need for a Y-rated capacitor between primary and secondary. Removal of the Y cap is necessary in voice applications to eliminate line frequency audio hum (“ground loops”). The common-mode inductance of L1 and the transformer construction attenuate common-mode conducted emission currents caused by the switching waveform on the DRAIN of U1, charging and discharging various stray capacitances. The differential inductance of L1 together with C15 attenuate differential-mode emission currents caused by the fundamental and harmonics of the primary current waveform.

The power supply passed the conducted EMI test (CISPR22B). The extended scan (to 100 MHz) was performed to detect high frequency peaks that could cause problems in radiated emissions. A vertical and a horizontal bobbin transformer were both evaluated for EMI. The vertical bobbin had slightly lower EMI and was selected for the final prototype.





## 5 PCB Layout



**Figure 3** – EP18 Printed Circuit Layout. Actual Size Board (L = 113 mm, W = 39 mm, H = 25 mm).

For the drain-to-source voltage waveforms, connect the high voltage probe tip to TP2 and the probe ground to test point TP1.

For switching current waveforms, add a wire loop in the provided holes and cut open the copper trace. Use a Tektronix A6302 current probe and AM503 current probe amplifier (with TM501 power module) or equivalent.

## 6 Bill Of Materials

### Bill Of Materials

Item	Qty.	Ref.	Description	Part number	Manufacturer
1	1	C1	33 $\mu$ F, 400 V, 105 $^{\circ}$ C	KMX400VB33	UCC
2	1	C2	1 nF, 1 kV, 6.5 mm, LS = 6.4mm		Philips Centra
3	1	C3	47 $\mu$ F, 10 V	KME10VB47RMX11LL	UCC
4	1	C4	47 $\mu$ F, 10 V	LXZ50VB47RM6X11LL	UCC
5	3	C5-C7	820 $\mu$ F 16 V / 1000 $\mu$ F, 16 V	EEU-FC1C821 / LXZ216VB102M10X20LL	Panasonic UCC
6	1	C8	100 $\mu$ F, 10 V	LXZ10VB101M5X11LL	UCC
7	1	C9	150 $\mu$ F, 6.3 V	LXZ6.3VB151M5X11LL	UCC
8	2	C10,11	0.1 $\mu$ F, 50 V	K104M15Z5UF5TH5	BC
9	1	C12	10 $\mu$ F, 50 V	EEU-FC1H100L	Panasonic
10	1	C13	2200 pF, 100 V, multilayer cer.	C315C222K1R5CA	Kemet
11	1	C14	1 $\mu$ F, 50 V, ceramic		Any
12	1	C15	0.1 $\mu$ F 250 VAC, X1	F1772-410-2000	Vishay
13	5	D1-D5	1 A, 1000 V	1N4007	General Semi.
14	1	D6	0.15 A, 75 V, 4 ns	1N4148	General Semi.
15	1	D7	1 A, 200 V, 50 ns	UF4003/UF1003	General Semi.
16	1	D8	3 A, 60 V, Schottky	SB360	General Semi.
17	1	D9	5 A, 40 V, Schottky	SB540	General Semi.
18	1	F1	250 VAC, 3.15 A	19372K	Wickman
19	1	J1	HEADER 3	26-48-1031	Molex
20	1	J2	HEADER 6	26-48-1061	Molex
21	1	L1	20 mH, 0.4 A	SS11V-05230	Tokin
22	2	L2, L3	3.3 $\mu$ H, 2.66 A	822MY-3R3M	Toko
23	1	L4	10 $\mu$ H, 130 mA		
24	1	R1	150 k $\Omega$ , 1/2 W		Any
25	2	R2, R3	1 M $\Omega$ , 1/4 W		Any
26	1	R4	6.8 $\Omega$ , 1/4 W		Any
27	2	R5,R8	10 $\Omega$ , 1/4 W		Any
28	1	R6	75 $\Omega$ , 1/4 W		Any
29	1	R7	1 k $\Omega$ , 1/4 W		Any
30	1	R9	100 $\Omega$ , 1/4 W		Any
31	1	R10	15.4 k $\Omega$ $\pm$ 1%, 1/4 W		Any
32	2	R11,R12	10.0 k $\Omega$ $\pm$ 1%, 1/4 W		Any
33	1	R13	12 k $\Omega$ , 1/4 W		Any
34	1	T1	EI25 XFMR (custom)	SIL6008 Rev D	HiCal
35	1	U1	TOPSwitch-GX	TOP243P	Power Integrations
36	1	U2	Optocoupler	LTV817A	Liteon
37	1	U3	Shunt Regulator, 2.5 V 1%	LM431BCZ	National Semiconduct



## 7 Transformer Specification

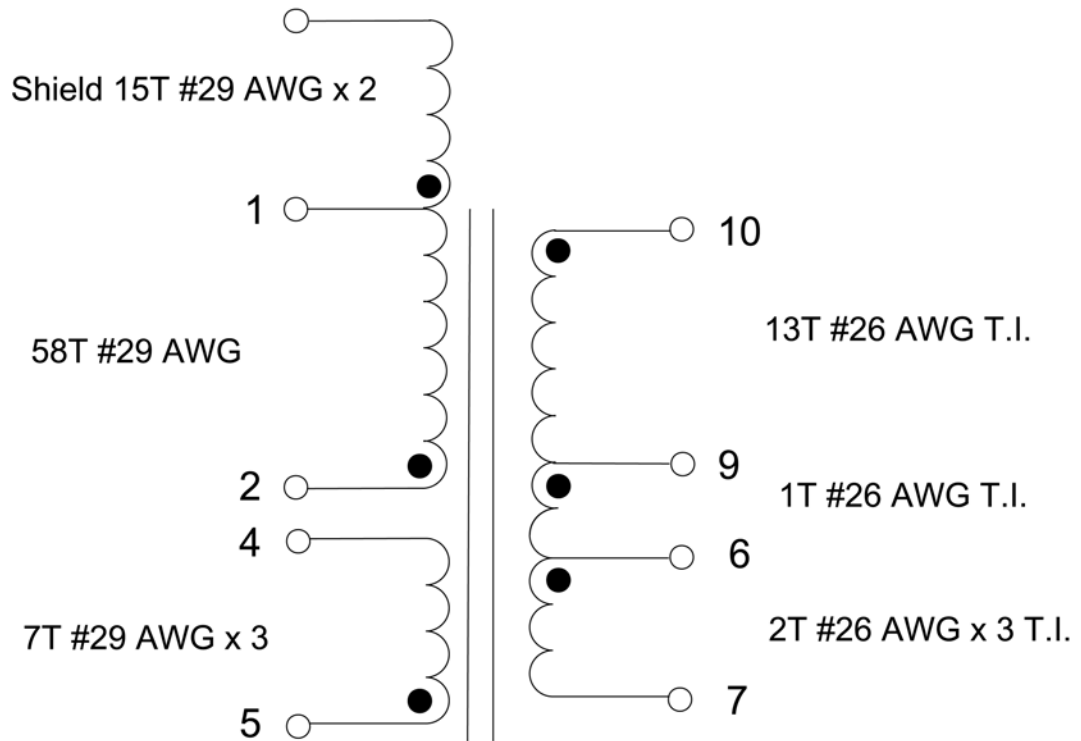


Figure 4 - EP18 Transformer Electrical Diagram.

### 7.1 Electrical Specifications

<b>Electrical Strength</b>	1 minute, 60 Hz, from Pins 1-5 to Pins 6-10	3000 VAC
<b>Primary Inductance</b>	Pins 1-2, all windings open, 130 kHz measurement frequency	1180 $\mu$ H +/-10%
<b>Resonant Frequency</b>	Pins 1-2, all windings open	0.5 MHz minimum
<b>Primary Leakage Inductance</b>	Pins 1-2, Pins 6-10 shorted, 130 kHz measurement frequency	30 $\mu$ H maximum

### 7.2 Materials

Item	Description
[1]	Core: EI25, Nippon Ceramic FEI-25, NC-2H material or equivalent, gapped for AL of 351 nH/T <sup>2</sup> . Note: Core longer than standard EI25.
[2]	Bobbin: YW-360-02B by YIH-HWA Enterprise, 10 PIN, with secondary-side pedestal. Pin 3 removed.
[3]	Magnet Wire: #29 AWG Heavy Nyleze
[4]	Triple Insulated Wire (TIW): #26 AWG
[5]	Tape: 3M 1298 Polyester Film (white) 10.58 mm wide by 2.2 mm thick
[6]	Varnish

### 7.3 Transformer Build Diagram

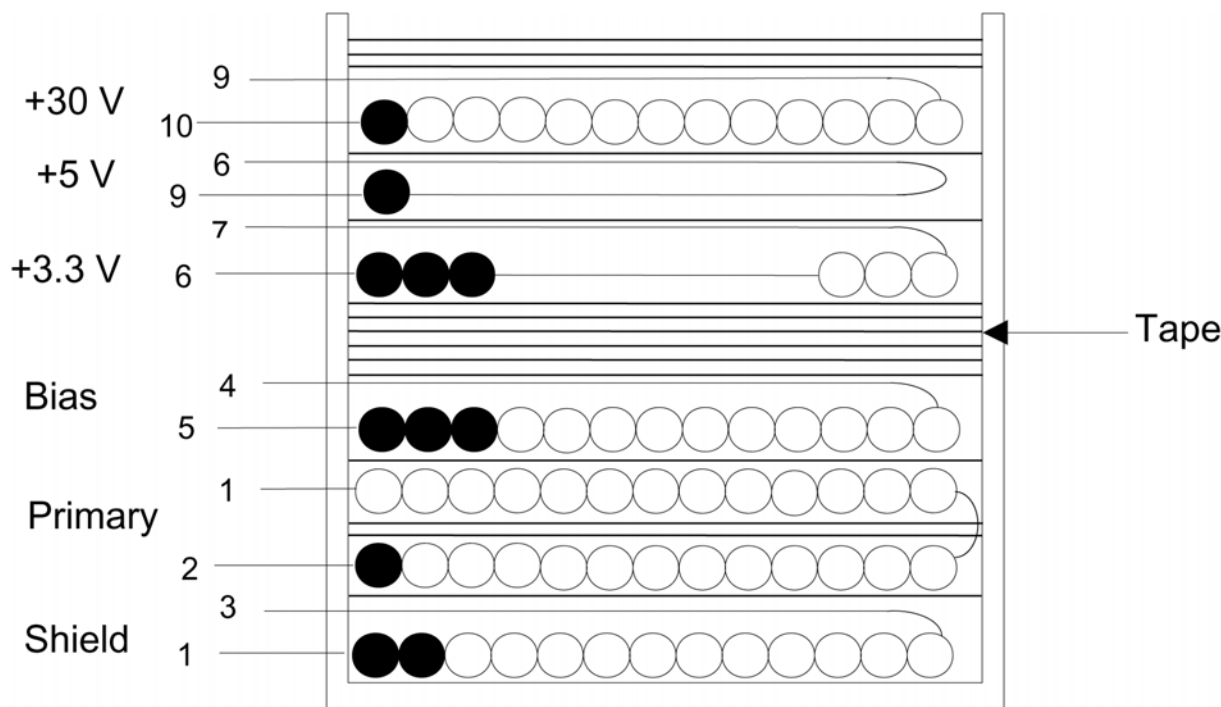


Figure 5 – EP18 Transformer Build Diagram.

### 7.4 Transformer Construction

<b>Shield</b>	Start at Pin 1. Wind 15 turns of item [3], bifilar parallel, from left to right, over entire length of the bobbin. Finish on Pin 3.
<b>Tape Insulation</b>	1 Layer of tape [5] for insulation
<b>Double Primary Layer</b>	Start at Pin 2. Wind 30 turns of item [3] from left to right over entire length of the bobbin. Apply 2 layers of tape, item [5], for <b>spacing</b> . Wind remaining 28 turns in the next layer from right to left, over entire length of the bobbin. Finish on Pin 1.
<b>Tape Insulation</b>	1 Layer of tape [5] for insulation.
<b>Bias Winding</b>	Start at Pin 5. Wind 7 turns parallel trifilar of item [3] from left to right, <b>uniformly over entire width of bobbin</b> . Finish on Pin 4.
<b>Tape Insulation</b>	6 Layers of tape [5] for <b>spacing</b> .
<b>3.3 V Winding</b>	Start at Pin 6. Wind 2 turns parallel trifilar of item [4] from left to right, <b>uniformly over entire width of bobbin</b> . Finish on Pin 7. Secure turns with 1 layer of tape.
<b>5 V Winding</b>	Start at Pin 9. Wind 1 turn of item [4] from left to right <b>over entire width of bobbin</b> . Finish on Pin 6. Secure turns with 1 layer of tape.
<b>30 V Winding</b>	Start at Pin 10. Wind 13 of item [4] from left to right uniformly, over entire width of bobbin. Finish on Pin 9.
<b>Tape Insulation</b>	3 Layers of tape [5] for insulation.
<b>Final Assembly</b>	Assemble core with the "I" <b>side on top</b> . Secure core. Dip varnish the transformer [6].



### 7.5 Design Notes

Power Integrations Device	TOP243P
Frequency of Operation	132 kHz
Mode	Continuous/Discontinuous
Peak Primary Current	0.42 A
Reflected Voltage	110 V
Maximum DC Input	375 V
Minimum DC Input	90 V

### 7.6 Transformer Sources

For information on the vendors used to source the transformers used on this board, please visit the *Power Integrations'* Web site at the URL below and select "Engineering Prototype Boards"

<http://www.powerint.com/componentsuppliers.htm>



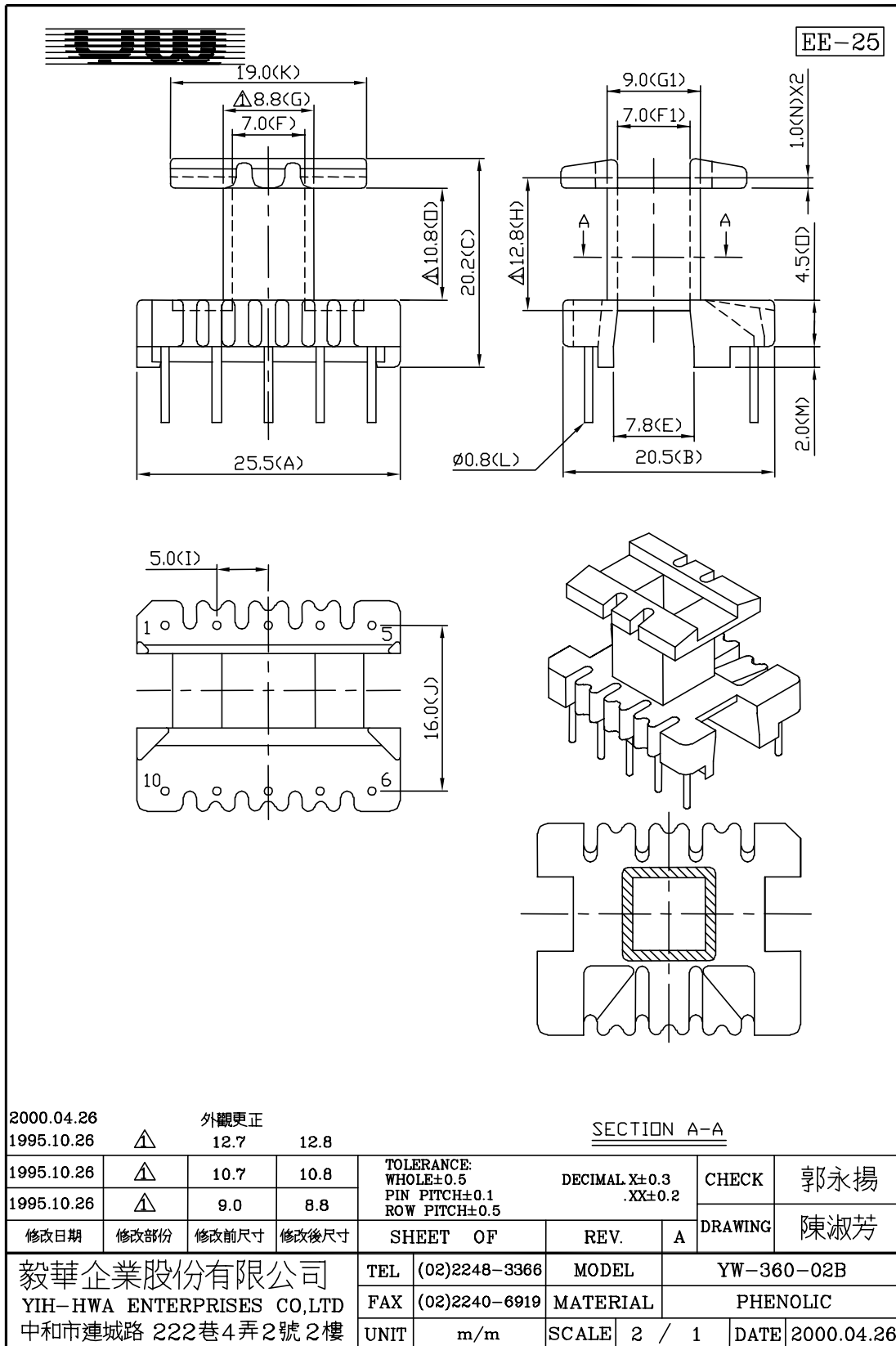


Figure 6 - E125 Bobbin Drawing.



## 8 Transformer Spreadsheets

### Power Supply Input

VACMIN	Volts	85				Minimum AC Input Voltage
VACMAX	Volts	265				Maximum AC Input Voltage
FL	Hertz	50				AC Main Frequency
TC	mSeconds	2.33				Bridge Rectifier Conduction Time Estimate
Z		0.65				Loss Allocation Factor
N	%	75.0				Efficiency Estimate

### Power Supply Outputs

			Out1	Out2	Out3	
Vox	Volts		3.30	5.00	30.00	Output Voltage
Iox	Amps		1.500	0.900	0.030	Power Supply Output Current
VB	Volts	12.00				Bias Voltage
IB	Amps	0.000				Bias Current

### Device Variables

Device		TOP243P				Device Name
PO	Watts	10.35				Total Output Power
VDRAIN	Volts	626				Maximum Drain Voltage Estimate (Includes Effect of Leakage Inductance)
VDS	Volts	3.6				Device On-State Drain to Source Voltage
FS	Hertz	132000				Device Switching Frequency
KRPKDP		0.70				Ripple to Peak Current Ratio
KI		1.00				External Current Limit Ratio
ILIMITEXT	Amps	0.70				Device Current Limit, External Mimimum
ILIMITMIN	Amps	0.70				Device Current Limit, Minimum
ILIMITMAX	Amps	0.80				Device Current Limit, Maximum
IP	Amps	0.42				Peak Primary Current
IRMS	Amps	0.22				Primary RMS Current
DMAX		0.56				Maximum Duty Cycle

### Power Supply Components Selection

CIN	μFarads	33.0				Input Filter Capacitor
VMIN	Volts	90				Minimum DC Input Voltage
VMAX	Volts	375				Maximum DC Input Voltage
VCLO	Volts	170				Clamp Zener Voltage
PZ	W	1.3				Estimated Primary Zener Clamp Loss
VDB	Volts	0.7				Bias Winding Diode Forward Voltage Drop
PIVB	Volts	55				Bias Rectifier Maximum Peak Inverse Voltage



## Power Supply Output Parameters

VDx	Volts		0.5	0.5	0.7	Output Winding Diode Forward Voltage Drop
PIVSx	Volts		16	24	135	Output Rectifier Maximum Peak Inverse Voltage
ISPx	Amps		5.55	3.33	0.11	Peak Secondary Current
ISRMSx	Amps		2.50	1.50	0.05	Secondary RMS Current
IRIPPLEx	Amps		2.01	1.20	0.04	Output Capacitor RMS Ripple Current

## Transformer Construction Parameters

Core/Bobbin		EI25				Core and Bobbin Type
Core Manuf.		Generic				Core Manufacturing
Bobbin Manuf.		Generic				Bobbin Manufacturing
LP	μHenries	1177				Primary Inductance
NP		58				Primary Winding Number of Turns
NB		6.68				Bias Winding Number of Turns
AWG	AWG	30				Primary Wire Gauge (Rounded to next smaller standard AWG value)
CMA	Cmils/A	472				Primary Winding Current Capacity (200 < CMA < 500)
VOR	Volts	110.00				Reflected Output Voltage
BW	mm	9.80				Bobbin Physical Winding Width
M	mm	0.0				Safety Margin Width
L		2.0				Number of Primary Layers
AE	cm <sup>2</sup>	0.41				Core Effective Cross Section Area
ALG	nH/T <sup>2</sup>	351				Gapped Core Effective Inductance
BM	Gauss	2093				Maximum Operating Flux Density
BP	Gauss	3977				Peak Flux Density (Bp < 4200)
BAC	Gauss	733				AC Flux Density for Core Curves
LG	mm	0.12				Gap Length (Lg > 0.051 for TOP22X, Lg > 0.1 for TOP23X)
LL	μH	23.5				Estimated Transformer Primary Leakage Inductance
LSEC	nH	20				Estimated Secondary Trace Inductance

## Secondary Parameters

NSx			2.00	2.89	16.16	Secondary Number of Turns
Rounded Down NSx				2	16	Rounded to Integer Secondary Number of Turns
Rounded Down Vox	Volts			3.30	29.70	Auxiliary Output Voltage for Rounded to Integer NSx
Rounded Up NSx				3	17	Rounded to Next Integer Secondary Number of Turns
Rounded Up Vox	Volts			5.20	31.60	Auxiliary Output Voltage for Rounded to Next Integer NSx
AWGSx Range	AWG		20 – 24	22 – 26	37 – 41	Secondary Wire Gauge Range (CMA range 500 – 200).





## 9 Performance Data

All measurements performed at room temperature, 60 Hz input frequency.

### TEST EQUIPMENT

INPUT: VOLTECH (PM100) AC POWER ANALYSER.  
 Power Line Meter (EPD Inc.)  
 OUTPUT: KIKUSUI (PLZ153W) ELECTRONIC LOAD.

### 9.1 Efficiency

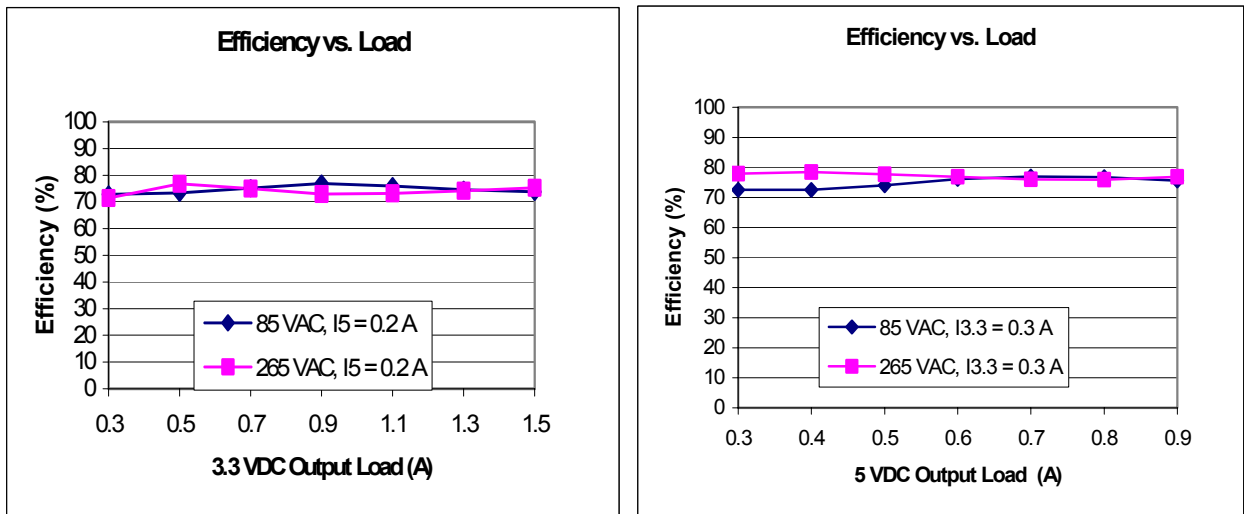


Figure 7 - Efficiency vs. Output Load.

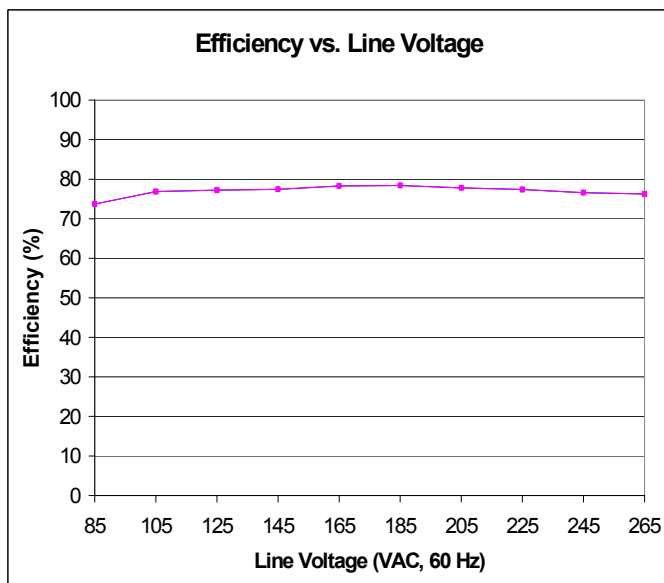


Figure 8 - Efficiency vs. Input Voltage at Full Load.



## 9.2 Regulation

### 9.2.1 Load

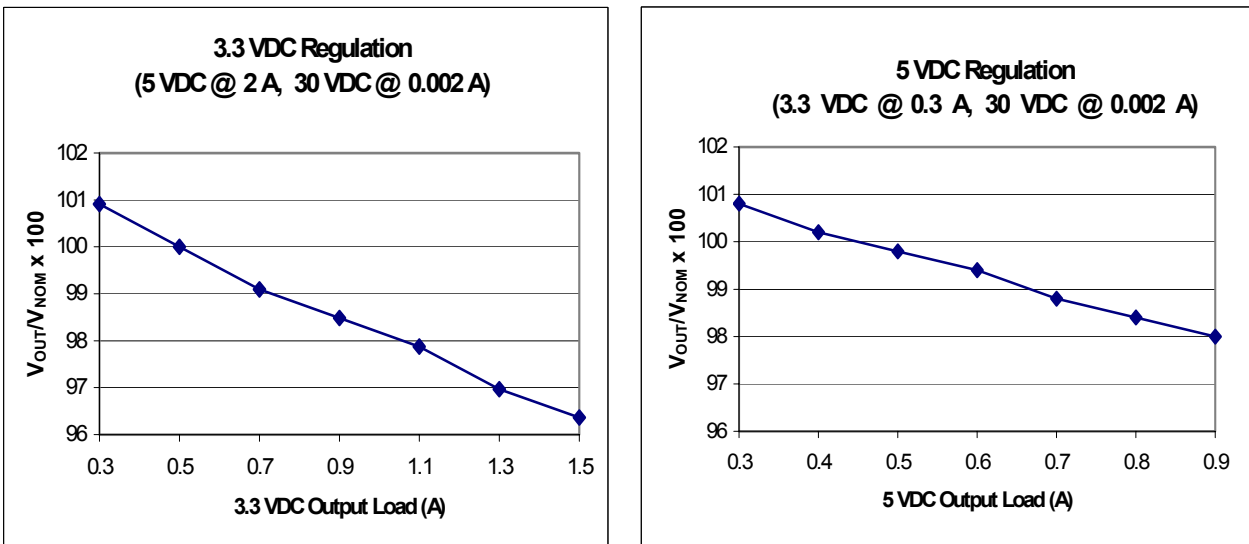


Figure 9 - Load Regulation at 85 VAC.

### 9.2.2 Line

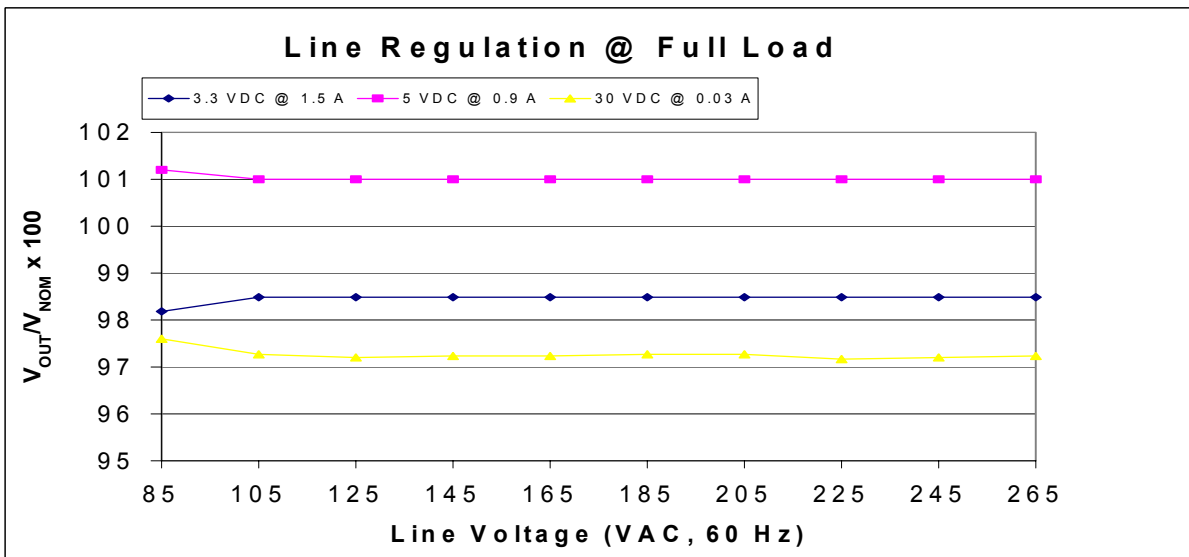


Figure 10 - Line Regulation at Full Load.



## 9.2.3 Cross-Regulation Table

V <sub>OUT</sub> (VDC) @ min (0), max (1) load, V <sub>IN</sub> = 85 VAC, 60 Hz						33	5.25	3.465
30	5	3.3	30	5	3.3	30	5	3.3
28.9	5.03	3.33	0	0	0	27	4.75	3.135
31.5	5.2	3.18	0	0	1			
30.6	4.88	3.41	0	1	0			
33	5.05	3.25	0	1	1			
27.5	5.04	3.33	1	0	0			
28.7	5.2	3.18	1	0	1			
28.2	4.9	3.4	1	1	0			
29.7	5.06	3.25	1	1	1			
		Min (A)	0.01	0.3	0.3			
		Max (A)	0.03	0.9	1.5			



## 10 Thermal Performance

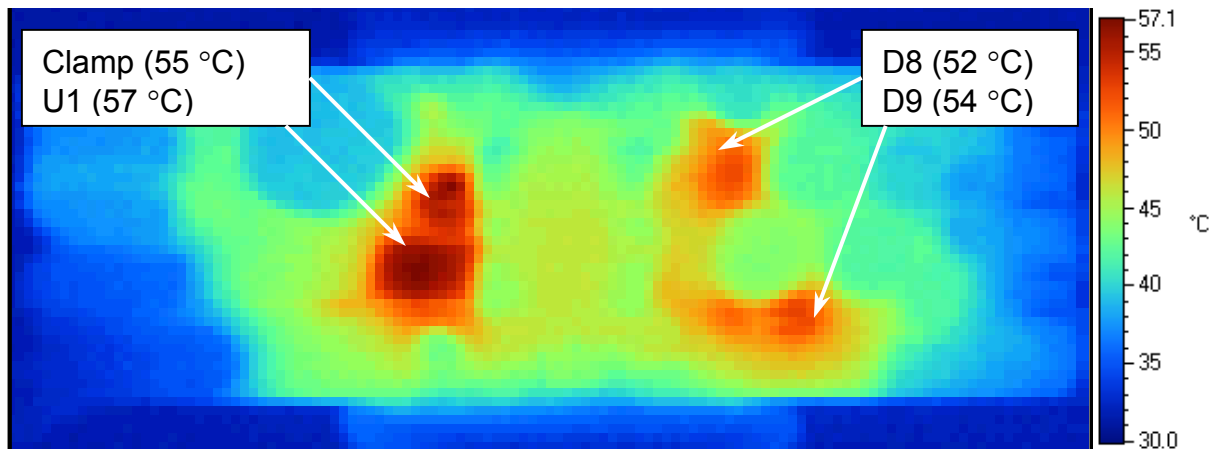
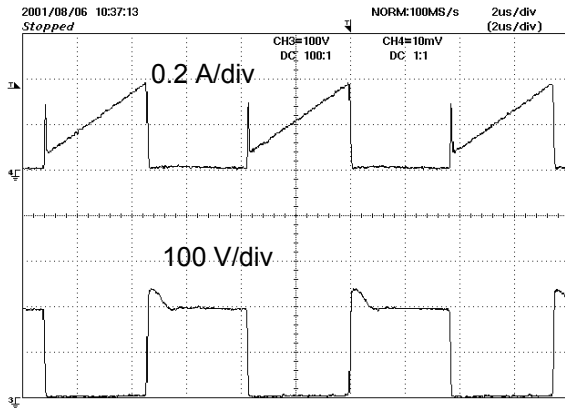


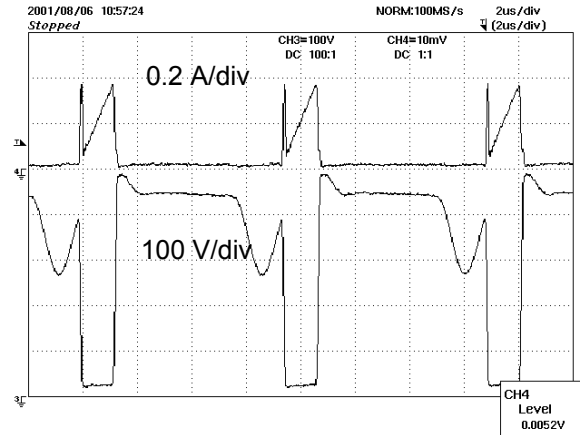
Figure 11 - Infrared Thermograph of EP18, 85 VAC Input, Full Load, 25 °C Ambient



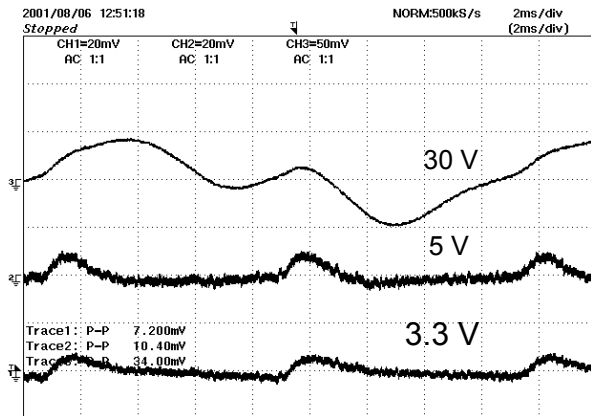
## 11 Waveform Scope Plots



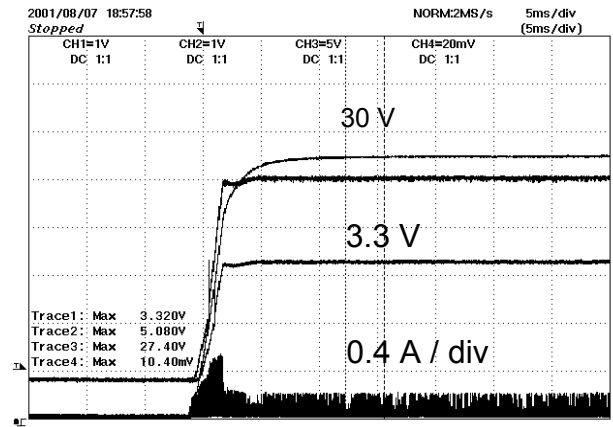
**Figure 12** - Drain Current and Drain-to-source Voltage at Full Load ( $V_{IN} = 85 \text{ VAC}$ , 60 Hz).



**Figure 13** - Drain Current and Drain-to-source Voltage at Full Load ( $V_{IN} = 265 \text{ VAC}$ , 60 Hz).



**Figure 14** - Output Voltage Ripple at Full Load ( $V_{IN} = 85 \text{ VAC}$  In, 60 Hz).

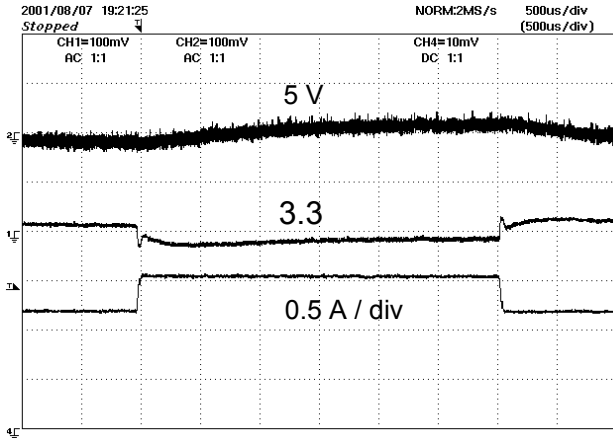


**Figure 15** - Primary Current and Output Voltages During Start-up at Minimum Load ( $V_{IN} = 265 \text{ VAC}$  In, 60 Hz).

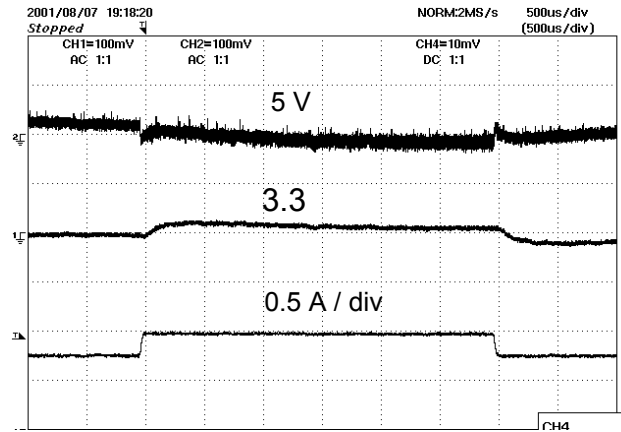


### 12 Load Transient Response (75% to 100% Load Step)

Transient response is measured by changing the load, at twice the input line frequency, from 75% and 100%. The peak of the output voltage response is controlled by the output capacitor ESR while the recovery time is controlled by the output filter and the loop response.

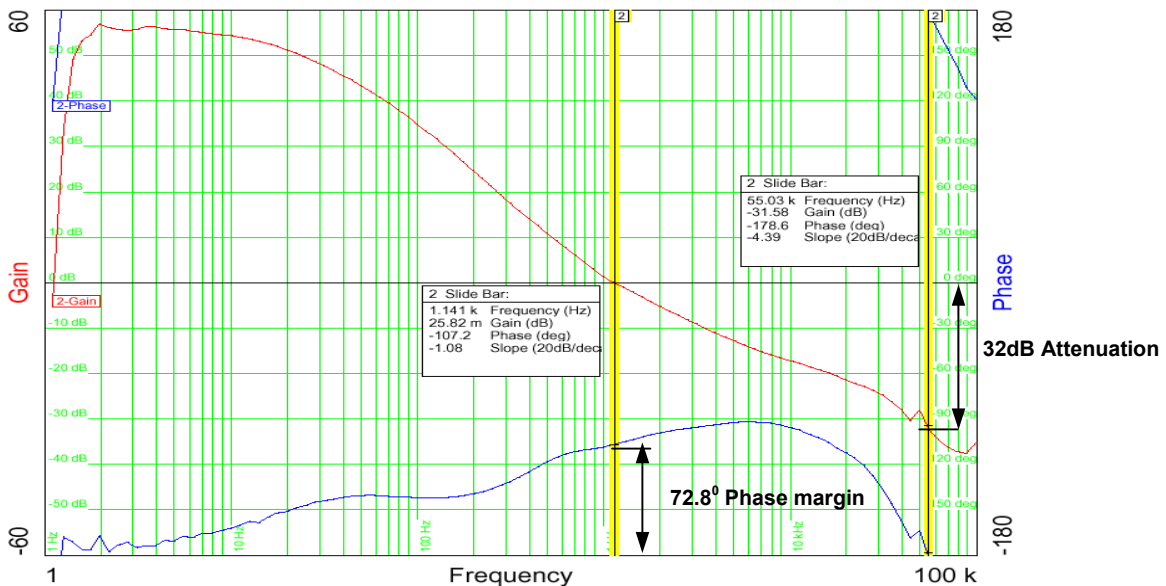


**Figure 16** - 3.3 V and 5 VDC Response to 3.3 V Load Step 75% - 100% (1.125 A to 1.5 A) at 85 VAC (5 V @ 0.9 A).



**Figure 17** - 3.3 V and 5 VDC Response to 5 V Load Step 75% - 100% (0.9 A to 0.675 A) at 85 VAC (3.3 V @ 1.5 A).

The stability of the power supply under various line and load conditions can be confirmed by observing the phase margin at crossover (0 dB) and the attenuation (-dB) at positive feedback ( $\geq 360^\circ$  Phase).



**Figure 18** - Worst Case Phase Margin and Gain (Full Load VAC).



### 13 Conducted EMI

The attached plots show worst-case EMI performance for EP-18 as compared to CISPR22B conducted emissions limits. The scans were extended to 70 MHz or 100 MHz to detect possible peaks that could radiate from the input/output conductors.

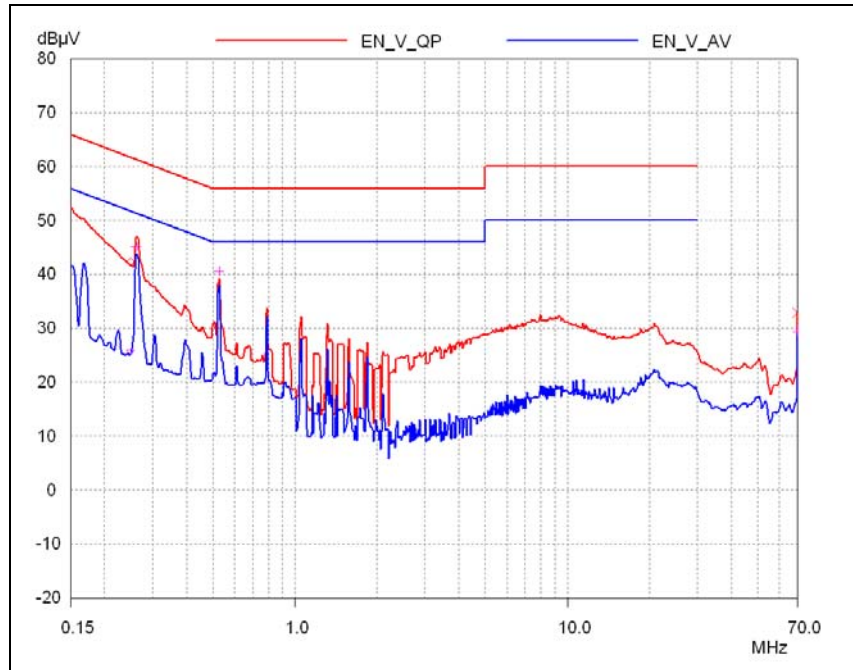


Figure 19 - Conducted EMI Results - Full Load, 115 VAC, Output RTN Floating.

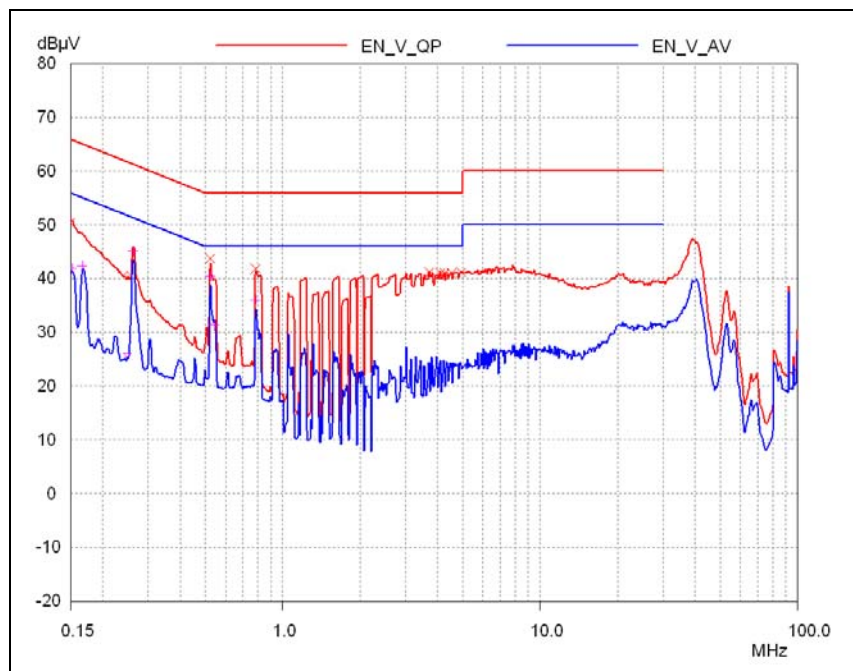


Figure 20 - Conducted EMI Results - Full Load, 115 VAC, Output RTN Grounded to PE.

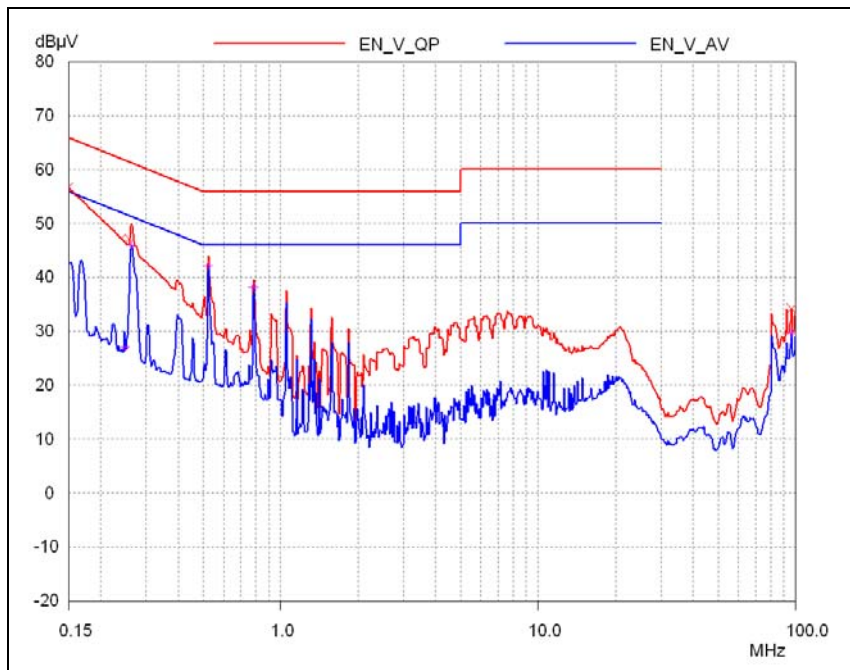


Figure 21 - Conducted EMI Results - Full Load, 230 VAC, Output RTN Floating.

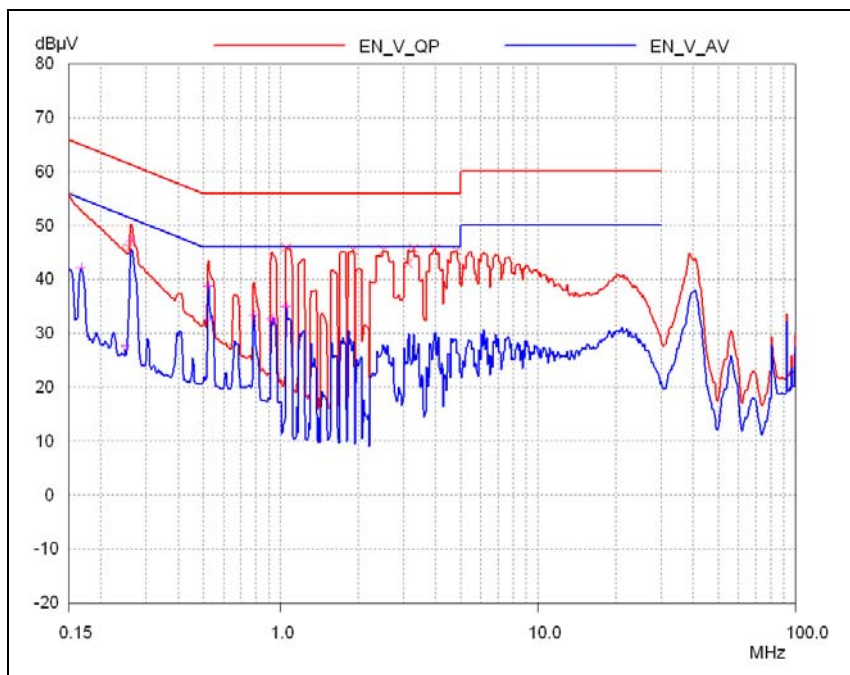


Figure 22 - Conducted EMI Results - Full Load, 230 VAC, Output Grounded to PE.





## 14 Surge Voltage

### **14.1 Differential = Line-to-Line (L-N), 2 $\Omega$ Source Impedance.**

The unit exceeded the 1 kV IEC/UL 1000-4-5 Class 3 requirement (meets Class 4, 2 kV).

### **14.2 Common Mode = Line-to-Ground (L-GND, N-GND), 12 $\Omega$ Source Impedance**

The unit exceeded the IEC/UL 1000-4-5 Class 3, 2 kV, meeting Class 4, 4 kV requirements.

All three outputs had monitor LEDs that showed no output disruption during the 90 high voltage surge pulses of Class 3 (FAST).

*During Class 4 testing, the outputs were disrupted for one second (LEDs blinked) when applying the 2 kV, 2  $\Omega$  differential pulse and the 4 kV, 12  $\Omega$  differential pulses (L1/GND, L2/GND), indicating the overvoltage shutdown protection was triggered.*

The outputs were unaffected during the 4 kV, 12  $\Omega$  common mode pulses (L1, L2/GND).

The unit was centered on the insulation side of a 6 in x 4 in single sided copper clad board (1.4 mm insulation), to avoid surface or insulation breakdown during the voltage surges.

The voltage was applied between the input terminals of the unit (L or N) and the copper clad ground plane (GND), in the following sequence:

L (+4 kV) to GND, 5 times  
L (-4 kV) to GND, 5 times  
N (+4 kV) to GND, 5 times  
N (-4 kV) to GND, 5 times  
L, N (+4 kV) to GND, 5 times  
L, N (-4 kV) to GND, 5 times



## 15 Revision History

<b>Date</b>	<b>Author</b>	<b>Revision</b>	<b>Description &amp; changes</b>
	SL	0.1	First draft
20-Jun-2001	SL	0.2	Single layer, through hole design
16-Jul-2001	SL	0.3	Implemented design review comments Eliminated Y cap, added 2 shield
31-Jul-2001	SL	0.4	windings and output diode snubber. Updated transformer design, test data
07-Aug-2001	SL	0.5	and pictures. Updated EMI and thermal image.
21-Nov-2002	PV	1.2	Minor text changes
05-Dec-2002	IM	1.3	Updates after review



**Notes**



**For the latest updates, visit our Web site: [www.powerint.com](http://www.powerint.com)**

The products and applications illustrated herein (including circuits external to the products and transformer construction) may be covered by one or more U.S. and foreign patents or potentially by pending U.S. and foreign patent applications assigned to Power Integrations. A complete list of Power Integrations' patents may be found at [www.powerint.com](http://www.powerint.com).

Power Integrations reserves the right to make changes to its products at any time to improve reliability or manufacturability. Power Integrations does not assume any liability arising from the use of any device or circuit described herein, nor does it convey any license under its patent rights or the rights of others.

The PI Logo, **TOPSwitch**, **TinySwitch** and **EcoSmart** are registered trademarks of Power Integrations, Inc.  
©Copyright 2002, Power Integrations, Inc.

**WORLD HEADQUARTERS****NORTH AMERICA - WEST**

Power Integrations, Inc.  
5245 Hellyer Avenue  
San Jose, CA 95138 USA.  
Main: +1-408-414-9200  
Customer Service:  
Phone: +1-408-414-9665  
Fax: +1-408-414-9765  
*e-mail:*  
[usasales@powerint.com](mailto:usasales@powerint.com)

**EUROPE & AFRICA**

Power Integrations (Europe) Ltd.  
Centennial Court  
Easthampstead Road  
Bracknell  
Berkshire RG12 1YQ,  
United Kingdom  
Phone: +44-1344-462-300  
Fax: +44-1344-311-732  
*e-mail:*  
[eurosales@powerint.com](mailto:eurosales@powerint.com)

**SINGAPORE**

Power Integrations, Singapore  
51 Goldhill Plaza #16-05  
Republic of Singapore,  
308900  
Phone: +65-6358-2160  
Fax: +65-6358-2015  
*e-mail:*  
[singaporesales@powerint.com](mailto:singaporesales@powerint.com)

**TAIWAN**

Power Integrations  
International Holdings, Inc.  
17F-3, No. 510  
Chung Hsiao E. Rd.,  
Sec. 5,  
Taipei, Taiwan 110, R.O.C.  
Phone: +886-2-2727-1221  
Fax: +886-2-2727-1223  
*e-mail:*  
[taiwansales@powerint.com](mailto:taiwansales@powerint.com)

**CHINA**

Power Integrations  
International Holdings, Inc.  
Rm# 1705, Bao Hua Bldg.  
1016 Hua Qiang Bei Lu  
Shenzhen Guangdong,  
518031  
Phone: +86-755-8367-  
5143  
Fax: +86-755-8377-  
9610  
*e-mail:*  
[chinasales@powerint.com](mailto:chinasales@powerint.com)

**KOREA**

Power Integrations  
International Holdings, Inc.  
Rm# 402, Handuk Building,  
649-4 Yeoksam-Dong,  
Kangnam-Gu,  
Seoul, Korea  
Phone: +82-2-568-7520  
Fax: +82-2-568-7474  
*e-mail:* [koreasales@powerint.com](mailto:koreasales@powerint.com)

**JAPAN**

Power Integrations, K.K.  
Keihin-Tatemono 1st Bldg.  
12-20 Shin-Yokohama  
2-Chome,  
Kohoku-ku, Yokohama-shi,  
Kanagawa 222-0033, Japan  
Phone: +81-45-471-1021  
Fax: +81-45-471-3717  
*e-mail:*  
[japansales@powerint.com](mailto:japansales@powerint.com)

**INDIA (Technical Support)**

Innovatech  
#1, 8th Main Road  
Vasanthnagar  
Bangalore, India 560052  
Phone: +91-80-226-6023  
Fax: +91-80-228-9727  
*e-mail:*  
[indiasales@powerint.com](mailto:indiasales@powerint.com)

