

---

<b>Title</b>	<b><i>Engineering Prototype Report for EP-33 – 45 W LCD Monitor External Power Supply using TOP247Y (TOPSwitch<sup>®</sup>-GX)</i></b>
<b>Specification</b>	90 - 265 VAC Input, 12 V, 3.75 A, 45 W Output
<b>Applications</b>	LCD Monitor / TV and Generic External Adapter
<b>Author</b>	Power Integrations Applications Department
<b>Document Number</b>	EPR-33
<b>Date</b>	28-Mar-03
<b>Revision</b>	1.0

### **Features**

- High efficiency (>79% at end of cord, >83% at supply output)
- Low zero load power consumption (< 0.25 W at 115 VAC, < 0.3 W at 230 VAC)
- <1 W input power at 0.5 W load
- Meets FCC part 15B and CISPR22 conducted EMI with margin even with output RTN connected to protective earth ground
- Design tailored to meet typical LCD monitor external supply specifications

The products and applications illustrated herein (including circuits external to the products and transformer construction) may be covered by one or more U.S. and foreign patents or potentially by pending U.S. and foreign patent applications assigned to Power Integrations. A complete list of Power Integrations' patents may be found at [www.powerint.com](http://www.powerint.com).

## Table Of Contents

1	Introduction .....	4
2	Power Supply Specification .....	5
3	Schematic .....	6
4	Circuit Description .....	7
4.1	Input EMI Filtering .....	7
4.2	TOPSwitch-GX Primary .....	7
4.3	Output Rectification .....	7
4.4	Output Feedback .....	7
5	PCB Layout .....	9
6	Bill Of Materials .....	10
7	Transformer Specification .....	11
7.1	Electrical Specifications .....	11
7.2	Materials .....	11
7.3	Transformer Build Diagram .....	12
7.4	Transformer Construction .....	12
7.5	Transformer Sources .....	12
8	Transformer Spreadsheet .....	13
9	Performance Data .....	15
9.1	Efficiency .....	15
9.2	No-load Input Power .....	16
9.3	Input Power at 0.5 W Load .....	16
9.4	Regulation .....	17
9.4.1	Load .....	17
9.4.2	Line .....	17
10	Thermal Performance .....	18
11	Waveforms .....	19
11.1	Drain Voltage and Current, Normal Operation .....	19
11.2	Output Voltage Start-up Profile .....	20
11.3	Drain Voltage and Current Start-up Profile .....	21
11.4	Load Transient Response (75% to 100% Load Step) .....	22
11.5	Output Ripple Measurements .....	23
11.5.1	Ripple Measurement Technique .....	23
11.5.2	Measurement Results .....	24
12	Control Loop Measurements .....	25
12.1	115 VAC Maximum Load .....	25
12.2	230 VAC Maximum Load .....	26
13	Conducted EMI .....	27
14	AC Surge and 100 kHz Ring Wave Immunity .....	28
14.1	Common Mode Surge, 1.2/50 $\mu$ sec .....	28
14.2	Differential Mode Surge, 1.2/50 $\mu$ sec .....	28
14.3	Common Mode, 100 kHz Ring Wave .....	29
14.4	Differential Mode, 100 kHz Ring Wave .....	29
15	Appendix .....	30
15.1	Input Cable Bill of Materials .....	30
15.2	Input Cable Assembly .....	30
15.3	Heat Sink Assembly .....	31
16	Revision History .....	32



**Important Note:**

Although the EP-33 is designed to satisfy safety isolation requirements, the engineering prototype has not been agency approved. Therefore, all testing should be performed using an isolation transformer to provide the AC input to the prototype board.



# 1 Introduction

This document is an engineering report describing a 12 V, 45 W power supply, with intended application such as W LCD monitor adapters. This document contains the power supply specification, schematic, bill of materials, transformer documentation, printed circuit board layout, and performance data.



Figure 1 - EP-33 Populated Circuit Board.



## 2 Power Supply Specification

Description	Symbol	Min	Typ	Max	Units	Comment
<b>Input</b>						
Voltage	$V_{IN}$	90		265	VAC	3 Wire
Frequency	$f_{LINE}$	47	50/60	64	Hz	
No-load Input Power (230 VAC)				0.3	W	Measured at 230 VAC, 60 Hz
<b>Output</b>						
Output Voltage 1	$V_{OUT1}$	11.5	12.00	12.6	V	±5%
Output Ripple Voltage 1	$V_{RIPPLE1}$			120	mV	20 MHz Bandwidth
Output Current 1	$I_{OUT1}$	0.0	3.75		A	
<b>Total Output Power</b>						
Continuous Output Power	$P_{OUT}$	45			W	
Peak Output Power	$P_{OUT\_PEAK}$	45			W	
<b>Efficiency</b>	$\eta$	83			%	Measured at $P_{OUT}$ (45 W), 25 °C
<b>Environmental</b>						
Conducted EMI						Meets CISPR22B / EN55022B
Safety						Designed to meet IEC950, UL1950 Class II
Surge		3			kV	1.2/50 $\mu$ s surge, IEC 1000-4-5, 12 $\Omega$ series impedance, differential and common mode
Surge		3			kV	100 kHz ring wave, 500 A short circuit current, differential and common mode
Ambient Temperature	$T_{AMB}$	0		50	°C	Free convection, sea level



### 3 Schematic

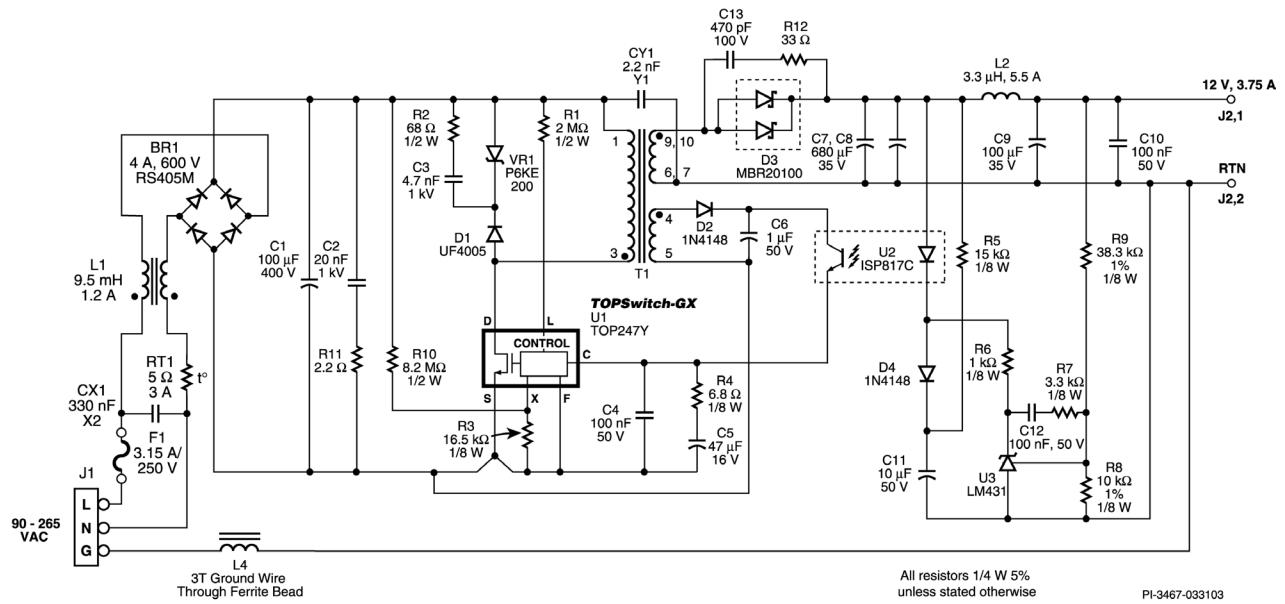


Figure 2 – EP-33 Schematic.



## 4 Circuit Description

The schematic in Figure 2 shows an off-line flyback converter using the TOP247Y. The circuit is designed for 90 VAC to 265 VAC input and 12 V, 3.75 A output.

### 4.1 Input EMI Filtering

Capacitor CX1 and the L1 leakage inductance filter differential-mode conducted EMI. Inductor L1 and CY1 filter common-mode conducted EMI. Inductor L4 damps line-cord resonance.

### 4.2 TOPSwitch-GX Primary

Rectifier bridge BR1 and C1 provide a high voltage DC BUS for the primary circuitry. C2 bypasses the high voltage DC rail. Resistor R11 provides damping that reduces mid-frequency conducted EMI. The DC rail is applied to the primary winding of T1. The other side of the transformer primary is driven by the integrated MOSFET in U1. Diode D1 and VR1 clamp leakage spikes generated when the MOSFET in U1 switches off. Capacitor C3 reduces the operating temperature of VR1 by bypassing the leading edge of the primary leakage spike away from VR1. Resistor R2 provides damping to reduce drain ringing. Resistor R1 sets the low-line turn-on threshold to approximately 69 VAC, and also sets the overvoltage shutdown level to approximately 320 VAC. R3 sets the U1 current limit to approximately 55% of its nominal value. This limits the output power delivered during fault conditions. C4 bypasses the U1 CONTROL pin. C5 has 3 functions. It provides the energy required by U1 during startup, sets the auto-restart frequency during fault conditions, and also acts to roll off the gain of U1 as a function of frequency. R4 adds a zero to stabilize the power supply control loop. Diode D2 and C6 provide rectified and filtered bias power for U2 and U1.

### 4.3 Output Rectification

The output of T1 is rectified and filtered by D3, C7, and C8. Inductor L2, C9, and C10 provide additional high frequency filtering. Resistor R12 and C13 provide snubbing for D3. Choosing the proper snubber values is important for low zero-load power consumption and for high frequency EMI suppression. The snubber components were chosen so that the turn-on voltage spike at the D3 anode is slightly under-damped. Increasing C13 and reducing R12 will improve damping and high frequency EMI, at the cost of higher zero-load power consumption.

### 4.4 Output Feedback

Resistors R8 and R9 divide down the supply output voltage and apply it to the reference pin of error amplifier U3. Shunt regulator U3 drives optocoupler U2 through resistor R6 to provide feedback information to the U1 CONTROL pin. The optocoupler output also provides power to U1 during normal operating conditions. Diode D4 and C11 apply drive to the optocoupler during supply startup to eliminate output voltage overshoot. Diode D4 isolates C11 from the supply feedback loop after startup. Resistor R5 discharges C11 when the supply is off.



Components C5, C12, R4, R6, and R7 all play a role in compensating the power supply control loop. Capacitor C5 rolls off the gain of U1 at relatively low frequency. Resistor R4 provides a zero to cancel the phase shift of C5. Resistor R6 sets the gain of the direct signal path from the supply output through U2 and U3. Components C12 and R7 roll off the gain of U3.





## 5 PCB Layout

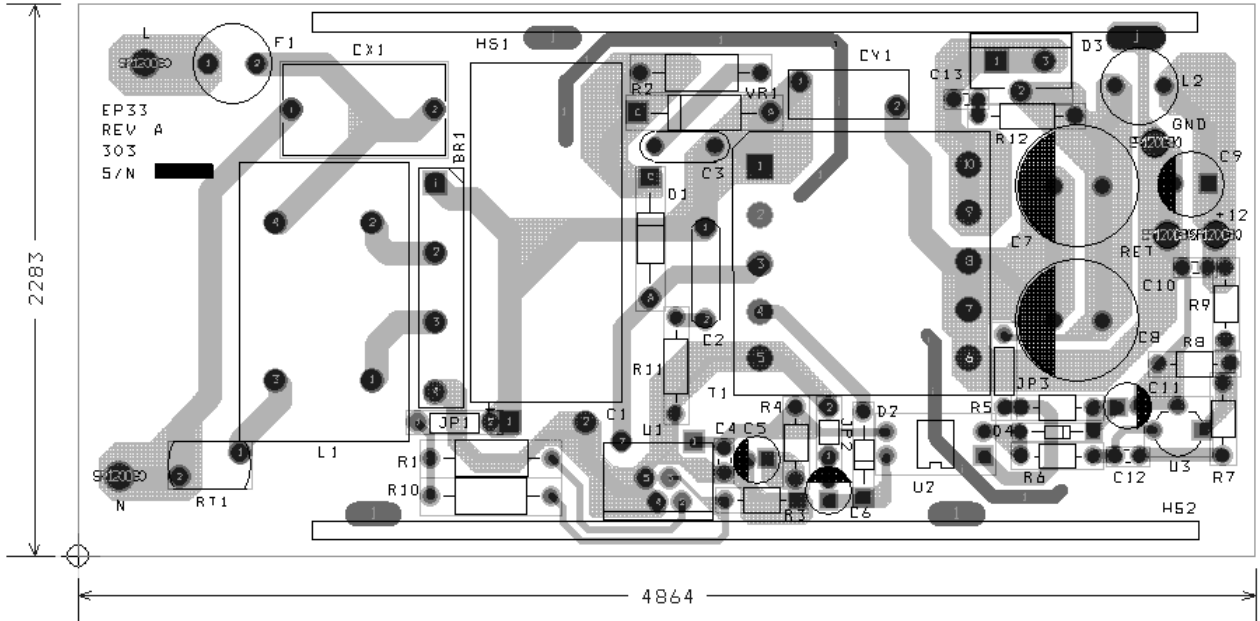


Figure 3 – EP-33 Printed Circuit Board Layout (dimensions 0.001”).



## 6 Bill Of Materials

EP-33 Rev. 10, 01/16/03

### Bill Of Materials

Item	Qty	Reference	Description	P/N	Manufacturer
1	1	CX1	0.33 $\mu$ F, 250 V, X2	ECQ-U2R334ML	Panasonic
2	1	C1	100 $\mu$ F, 400 V	PAG400VB101M16X30	United Chemicon
3	1	C2	20 nF, 1 kV disc	5GAS20	Vishay
4	1	C3	4.7 nF, 1 kV disc	5GAD47	Vishay
5	3	C4, 10, 12	100 nF, 50 V	C320C104K1R5CA	Kemet
6	1	C5	47 $\mu$ F, 16 V, 105 °C	ECA-1CHG470	Panasonic
7	1	C6	1 $\mu$ F, 50 V, 105 °C	ECA-1HHG010	Panasonic
8	1	CY1	2.2 nF, Y1	440LD22	Cera-Mite
9	2	C7, 8	680 $\mu$ F, 35 V, low ESR	KZE35VB681M12.5X20	United Chemicon
10	1	C9	100 $\mu$ F, 35 V, 105 °C	ECA-1VHG101	Panasonic
11	1	C11	10 $\mu$ F, 50 V, 105 °C	ECA-1HHG100	Panasonic
12	1	C13	470 pF, 100 V, X7R	C315C471K1R5CA	Kemet
13	1	BR1	Bridge, 4 A, 600 V	RS405M	Rectron
14	1	D1	1 A, 600 V, 75 ns UF4005		General Semiconductor
15	1	D2, 4	Diode, Signal	1N4148	
16	1	D3	20 A, 100 V, Schottky	MBR20100	General Semiconductor
17	1	F1	Fuse, 250 VAC, 3.15 A	372-1315	Wickman
18	1	L1	9.5 mH, 1.2 A	ELF-18N012A	Panasonic
19	1	L2	3.3 $\mu$ H, 5.5 A	6000-3R3M	J. W. Miller
20	1	R1	2 M $\Omega$ , 5%, 1/2 W		Any
21	1	R2	68 $\Omega$ , 5%, 1/2 W		Any
22	1	R3	16.5 k $\Omega$ , 1%, 1/8 W		Any
23	1	R4	6.8 $\Omega$ , 5%, 1/8 W		Any
24	1	R5	15 k $\Omega$ , 5%, 1/8 W		Any
25	1	R6	1 k $\Omega$ , 5%, 1/8 W		Any
26	1	R7	3.3 k $\Omega$ , 5%, 1/8 W		Any
27	1	R8	10 k $\Omega$ , 1%, 1/8 W		Any
28	1	R9	38.3 k $\Omega$ , 1%, 1/8 W		Any
29	1	R10	8.2 M $\Omega$ , 5%, 1/2 W		Any
30	1	R11	2.2 $\Omega$ , 5%, 1/4 W		Any
31	1	R12	33 $\Omega$ , 1/4 W, 5%		Any
32	1	T1	Transformer, EE28	545 90 009 00 SIL6019 EXL-529 Rev. B	Vogt Hical Excel Electric
33	1	U1	TOP247Y		Power Integrations
34	1	U2	Optocoupler Graded CTR	ISP817C	Isocom
35	1	U3	Shunt Regulator, TO-92	LM431ACZ	National Semiconductor
36	1	VR1	TVS, 200 V	P6KE200	On Semiconductor
37	1	RT1	Thermistor, 5 $\Omega$ , 3 A	SCK-053	Thinking Electronic
38	1	J1	Assembly, AC Receptacle		see Appendix
39	1	J2	Assembly, Output Cable, 6', 2 x 18 gauge, 2.5 mm female barrel connector, 14.3 mm x 28.6 mm molded ferrite filter		see Appendix
40	2	HS1, HS2	Assembly, EP-33 Heat Sink		see Appendix
41	2	U1, D3	Screw, 4-40 Phil Flat Undercut Zinc, 5/16"		
42	2	U1, D3	Nut, 4-40 Kep Zinc		
43	1	D3	Insulator, Silicone TO-220	188858F00000	Aavid/Thermalloy
44	1	D3	4-40 Shoulder Washer 0.031" Shank	3049	Keystone Electronics
45	2	U1, D3	Washer, 4-40 Zinc		
46	A/R	JP1-3	Bus Wire, 22 AWG		
47	1		EP-33 PCB, Rev. A		



## 7 Transformer Specification

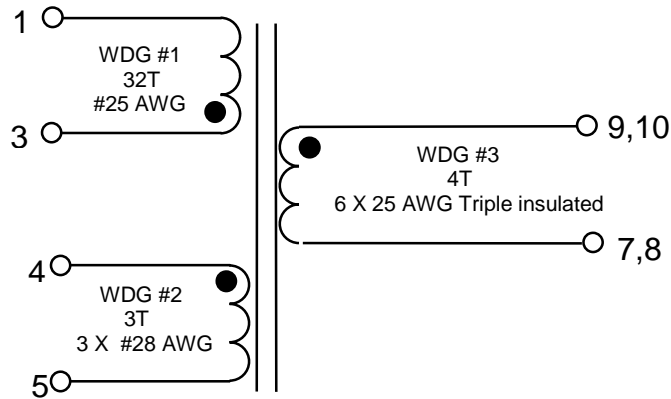


Figure 4 – EP-33 Triple Insulated Transformer.

### 7.1 Electrical Specifications

<b>Electrical Strength</b>	60 Hz, 1 min, from Pins 1-5 to Pins 6-10	3000 VAC
<b>Creepage</b>	Between Pins 1-5 and Pins 6-10	6 mm (Min.)
<b>Primary Inductance</b>	Pins 1-3, all other windings open, measured at 100 kHz	521 $\mu$ H, $\pm 10\%$
<b>Resonant Frequency</b>	Pins 1-3, all other windings open	1.2 MHz (Min.)
<b>Primary Leakage Inductance</b>	Pins 1-3, with Pins 6-10 shorted, measured at 100 kHz	12 $\mu$ H (Max.)

### 7.2 Materials

Item	Description
[1]	Core: Nippon Ceramic FEE28/21/11, NC-2H material or equivalent. Gap for AL of 509 nH/T <sup>2</sup>
[2]	Bobbin: 10 Pin EI28, Vertical Mount, Yih Hwa YW-490 or equivalent
[3]	Magnet Wire: #25 AWG Double Coated
[4]	Magnet Wire: #28 AWG Double Coated
[5]	Triple Insulated Wire: #25 AWG
[6]	Tape, 3M #1298 or equiv. 8.6 mm wide
[7]	Varnish



### 7.3 Transformer Build Diagram

Pins Side

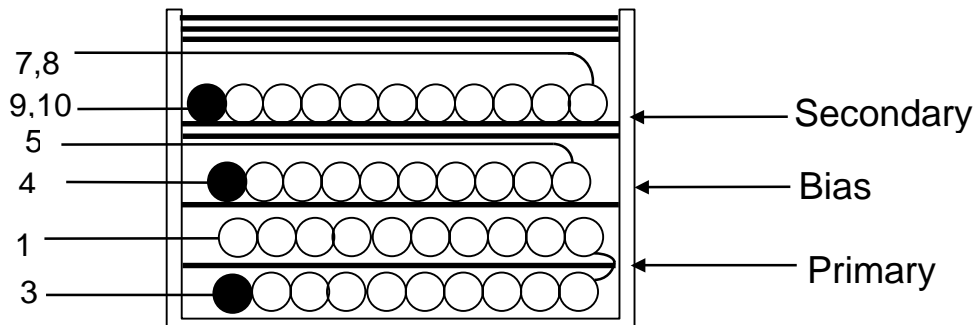


Figure 5 - EP-33 Transformer Build Diagram.

### 7.4 Transformer Construction

<b>1/2 Primary</b>	Start at Pin 3. Wind 16 turns of item [3] in one layer.
<b>Basic Insulation</b>	Apply one layer of item [6] over completed winding layer.
<b>1/2 Primary</b>	Wind remaining 16 turns, finish on Pin 1.
<b>Basic Insulation</b>	Apply one layer of item [6] for basic insulation.
<b>Trifilar Bias winding</b>	Starting at Pin 4, wind 3 trifilar turns of item [4]. Spread turns evenly across bobbin. Finish at Pin 5.
<b>Basic Insulation</b>	Use two layers of item [6] for basic insulation.
<b>Hexafilar Secondary Winding</b>	Start at Pins 9 and 10. Wind 4 hexafilar turns of item [5]. Spread turns evenly across bobbin. Finish on Pins 7 and 8.
<b>Outer Wrap</b>	Wrap windings with 3 layers of tape (item [6]).
<b>Final Assembly</b>	Assemble and secure core halves. Varnish impregnate (item [7]).

### 7.5 Transformer Sources

For information on the vendors used to source the transformers used on this board, please visit the *Power Integrations'* Web site at the URL below and select "Engineering Prototype Boards".

<http://www.powerint.com/componentsuppliers.htm>



## 8 Transformer Spreadsheet

### Power Supply Input

VACMIN	Volts	89	Min Input AC Voltage
VACMAX	Volts	265	Max Input AC Voltage
FL	Hertz	50	AC Main Frequency
TC	msonds	2.11	Bridge Rectifier Conduction Time Estimate
Z		0.49	Loss Allocation Factor
N	%	80.0	Efficiency Estimate

### Power Supply Outputs

VOx	Volts		12.00	Output Voltage
IOx	Amps		3.750	Output Current
VB	Volts	12.00		Bias Voltage
IB	Amps	0.006		Bias Current

### Device Variables

Device		TOP247Y/ F		Device Name
PO	Watts	45.07		Total Output Power
VDRAIN	Volts	605		Maximum Drain Voltage Estimate (Includes Effect of Leakage Inductance)
VDS	Volts	3.9		Device On-State Drain to Source Voltage
FS	Hertz	132000		Device Switching Frequency
KRPKDP		0.40		Ripple to Peak Current Ratio
KI		0.55		External Current Limit Ratio
ILIMITEXT	Amps	1.84		Device Current Limit External Minimum
ILIMITMIN	Amps	3.35		Device Current Limit Minimum
ILIMITMAX	Amps	3.85		Device Current Limit Maximum
IP	Amps	1.52		Peak Primary Current
IRMS	Amps	0.91		Primary RMS Current
DMAX		0.56		Maximum Duty Cycle

### Power Supply Components Selection

CIN	uFarads	100.0		Input Filter Capacitor
VMIN	Volts	83		Minimum DC Input Voltage
VMAX	Volts	375		Maximum DC Input Voltage
VCLO	Volts	150		Clamp Zener Voltage
PZ	Watts	2.1		Estimated Primary Zener Clamp Loss
VDB	Volts	0.7		Bias Winding Diode Forward Voltage Drop
PIVB	Volts	60		Bias Rectifier Maximum Peak Inverse Voltage



**Power Supply Output Parameters**

VDx	Volts		0.5	Output Winding Diode Forward Voltage Drop
PIVSx	Volts		59	Output Rectifier Maximum Peak Inverse Voltage
ISPx	Amps		11.95	Peak Secondary Current
ISRMSx	Amps		6.43	Secondary RMS Current
IRIPPLEx	Amps		5.22	Output Capacitor RMS Ripple Current

**Transformer Construction Parameters**

Core/Bobbin		EI28		Core and Bobbin Type
Core Manuf.		Generic		Core Manufacturing
Bobbin Manuf		Generic		Bobbin Manufacturing
LP	uHenries	521		Primary Inductance
NP		32		Primary Winding Number of Turns
NB		4.06		Bias Winding Number of Turns
<b>AWG</b>	<b>AWG</b>	<b>24</b>		<b>Primary Wire Gauge (Rounded to next smaller standard AWG value) Warning! Primary wire gauge is less than recommended minimum (26 AWG) and may overheat Tip: Consider a parallel winding technique (bifilar, trifilar), increase size of transformer (larger BW)</b>
CMA	Cmils/A	444		Primary Winding Current Capacity
VOR	Volts	100.00		Reflected Output Voltage
BW	mm	9.60		Bobbin Physical Winding Width
M	mm	0.0		Safety Margin Width
L		2.0		Number of Primary Layers
AE	cm <sup>2</sup>	0.86		Core Effective Cross Section Area
ALG	nH/T <sup>2</sup>	509		Gapped Core Effective Inductance
BM	Gauss	2871		Maximum Operating Flux Density
BP	Gauss	4013		Peak Flux Density
BAC	Gauss	574		AC Flux Density for Core Curves
LG	mm	0.19		Gap Length
LL	uHenries	3.9		Estimated Transformer Primary Leakage Inductance
LSEC	nHenries	10		Estimated Secondary Trace Inductance

**Secondary Parameters**

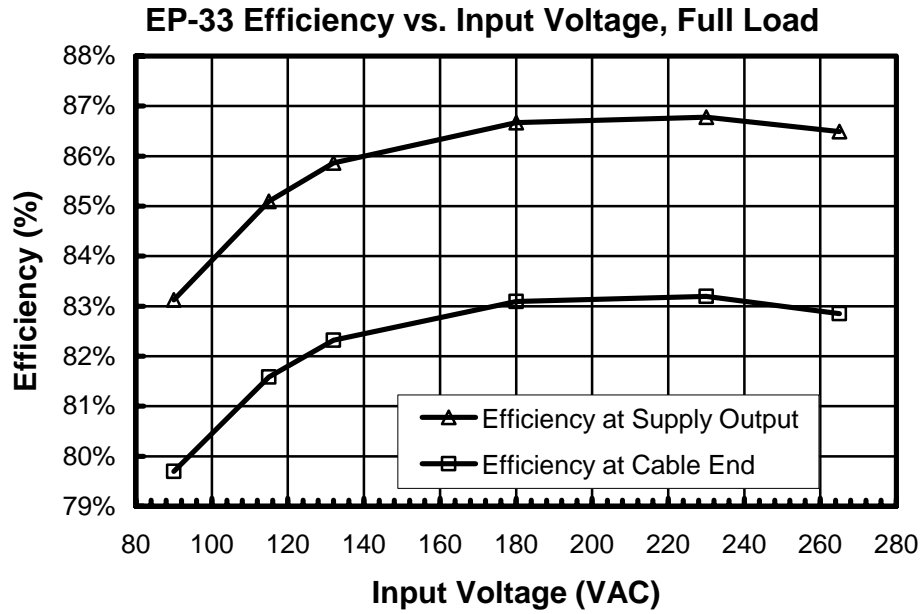
NSx			4.00	Secondary Number of Turns
Rounded Down NSx				Rounded to Integer Secondary Number of Turns
Rounded Down Vox	Volts			Auxiliary Output Voltage for Rounded to Integer NSx
Rounded Up NSx				Rounded to Next Integer Secondary Number of Turns
Rounded Up Vox	Volts			Auxiliary Output Voltage for Rounded to Next Integer NSx
AWGSx Range	AWG		15 - 19	Secondary Wire Gauge Range Comment: Primary wire gauge is less than recommended minimum (26 AWG) and may overheat Tip: Consider a parallel winding technique (bifilar, trifilar), increase size of transformer (larger BW) or reduce margin (M).



## 9 Performance Data

All measurements performed at room temperature, 60 Hz input frequency.

### 9.1 Efficiency



**Figure 6** - Efficiency vs. Input Voltage, Full Load, Room Temperature, 60 Hz.



**9.2 No-load Input Power**

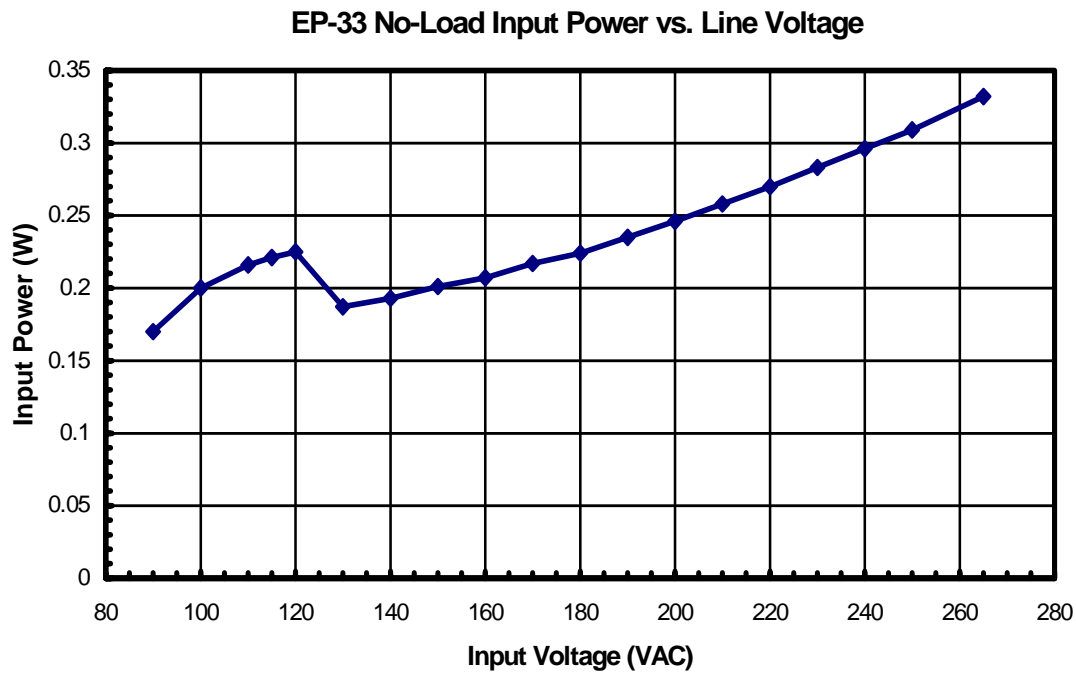


Figure 7 – No-Load Input Power vs. Input Line Voltage, Room Temperature, 60 Hz.

**9.3 Input Power at 0.5 W Load**

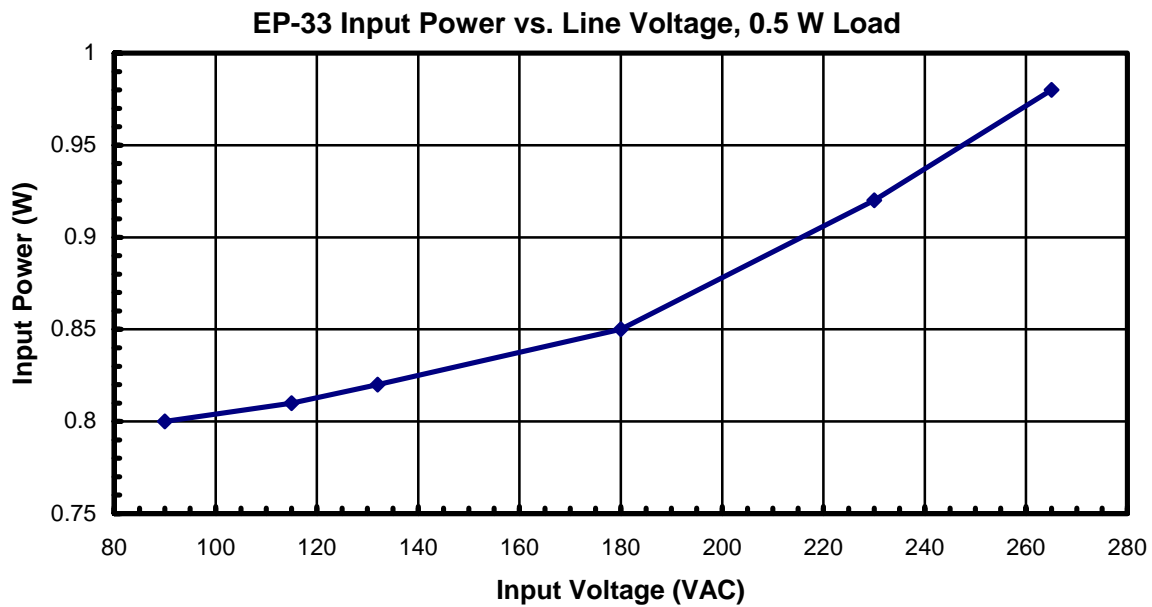


Figure 8 – Input Power vs. Line Voltage, 0.5 W Load, Room Temperature.





**9.4 Regulation**

9.4.1 Load

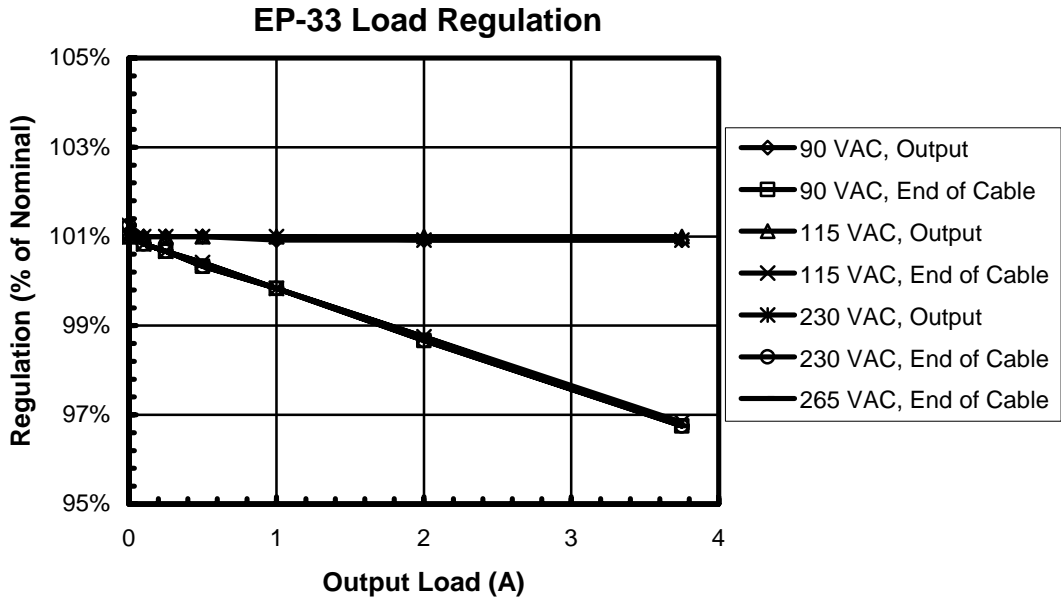


Figure 9 - Load Regulation, Room Temperature.

9.4.2 Line

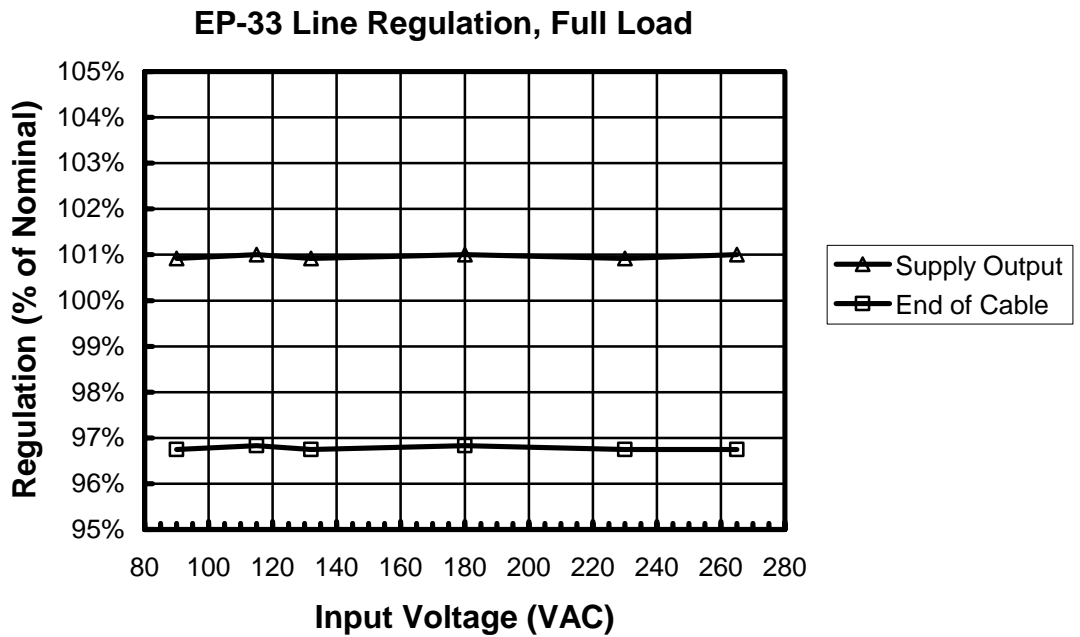


Figure 10 - Line Regulation, Maximum Load, Room Temperature.



### 10 Thermal Performance

Item	Temperature (°C)					
	90 VAC	115 VAC	230 VAC	90 VAC	115 VAC	230 VAC
Thermistor (RT1)	73	64	44	93	80	65
Balun (L1)	48	42	32	78	67	58
Bridge (BR1)	72	61	49	97	85	71
TOPSwitch-GX (U1)	60	53	52	91	84	78
Clamp Zener (VR1)	93	84	70	115	103	92
Transformer (T1)	64	60	56	90	89	80
Rectifier (D3)	83	80	73	107	102	98
Ambient	25	25	26	50	50	49

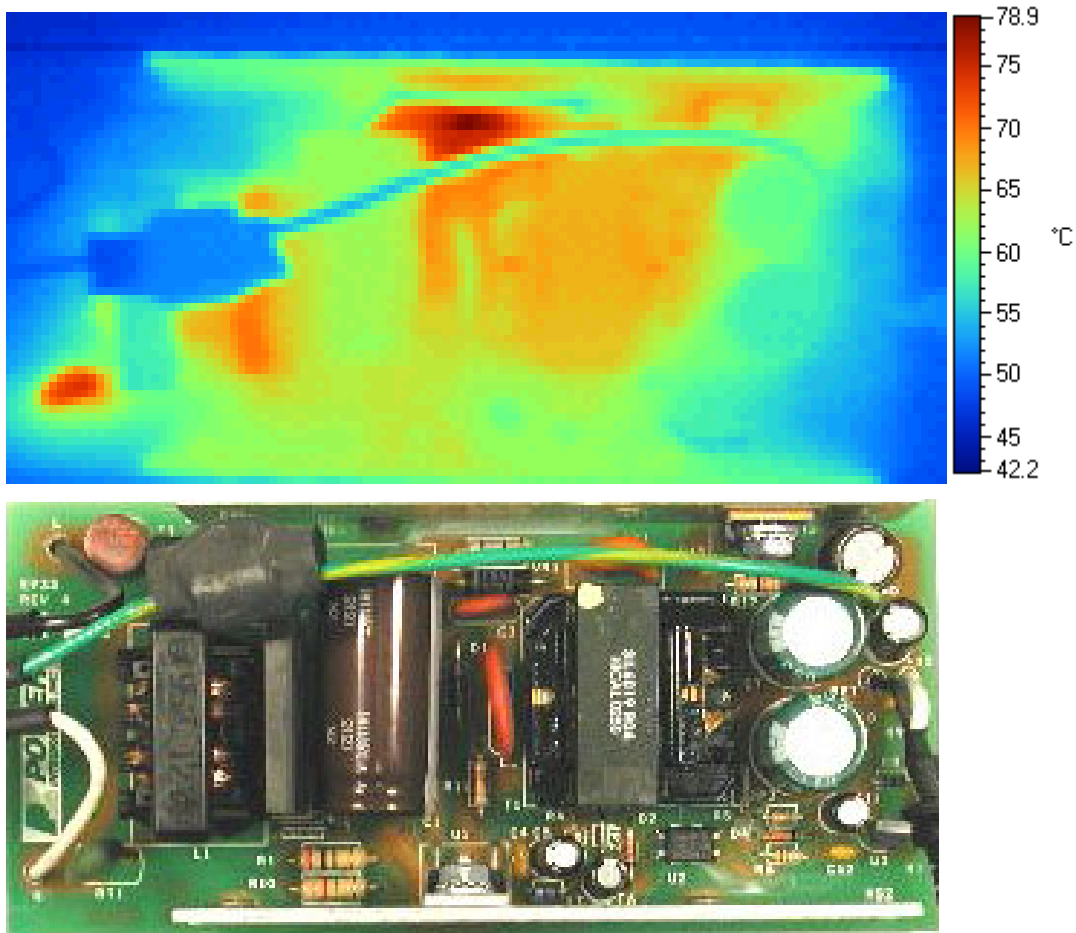
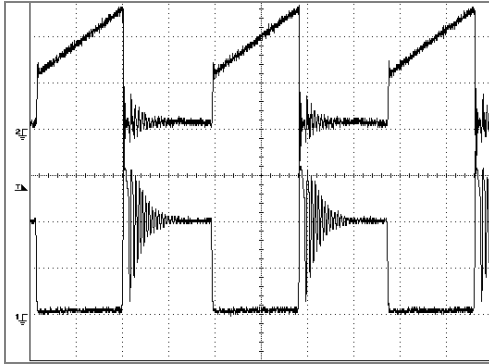


Figure 11 – Infrared Thermograph of EP-33, 90 VAC Input, Full Load, 25 °C Ambient.

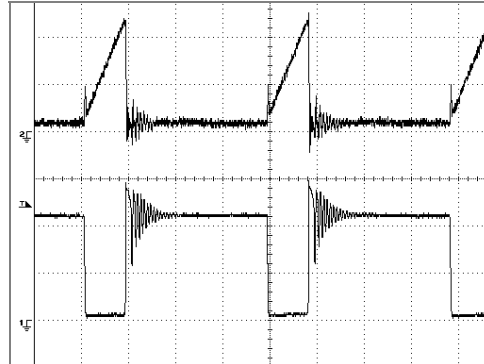


## 11 Waveforms

### 11.1 Drain Voltage and Current, Normal Operation



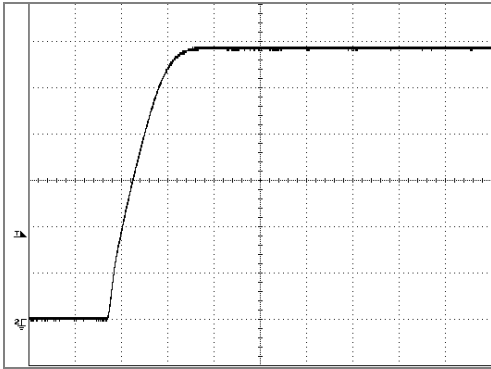
**Figure 12** - 90 VAC - Upper:  $I_{DRAIN}$ , 0.5 A/div.  
Lower:  $V_{DRAIN}$ , 100 V, 2  $\mu$ s/div.



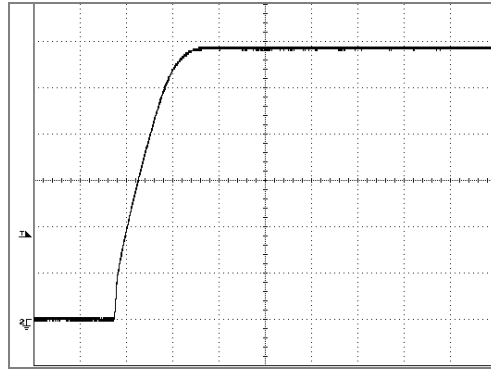
**Figure 13** - 265 VAC, Full Load  
Upper:  $I_{DRAIN}$ , 0.5 A/div.  
Lower:  $V_{DRAIN}$ , 200 V, 2  $\mu$ s/div.



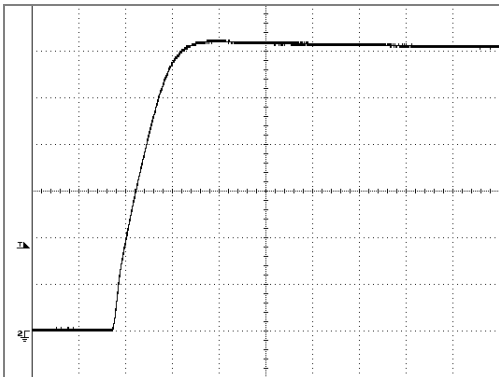
### 11.2 Output Voltage Start-up Profile



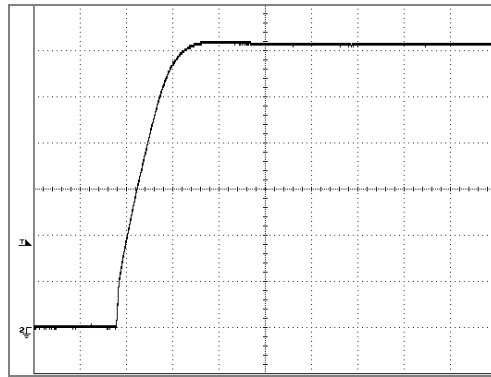
**Figure 14** - Start Up Profile at Supply Output, Full Load, 115 VAC, 2 V, 10 ms/div.



**Figure 15** - Start Up Profile at Supply Output Zero Load, 115 VAC. 2 V, 10 ms/div.



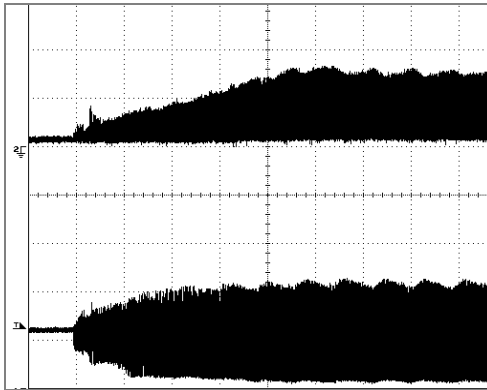
**Figure 16** - Start-up Profile at Supply Output Full Load, 230 VAC. 2 V, 10 ms/div.



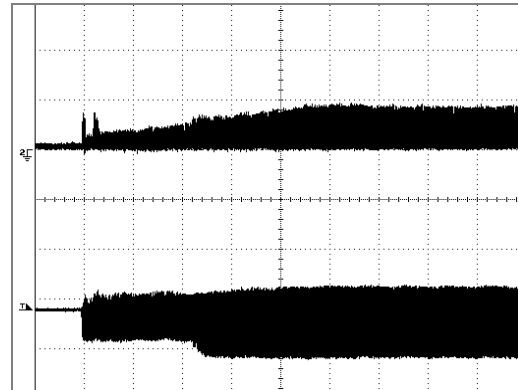
**Figure 17** - Start Up Profile at Supply Output Zero Load, 230 VAC, 2 V, 10 ms/div.



### 11.3 Drain Voltage and Current Start-up Profile



**Figure 18** - 90 VAC Input and Maximum Load.  
Upper:  $I_{\text{DRAIN}}$ , 0.5 A/div.  
Lower:  $V_{\text{DRAIN}}$ , 100 V, 10 ms/div.

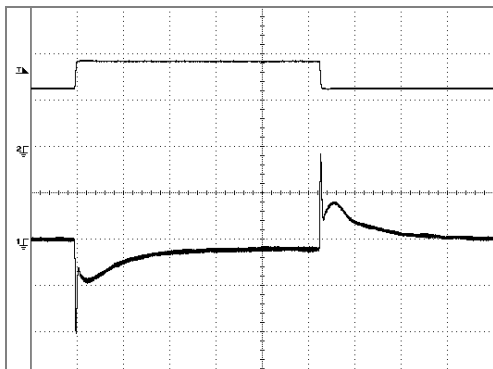


**Figure 19** - 265 VAC Input and Maximum Load.  
Upper:  $I_{\text{DRAIN}}$ , 0.5 A/div.  
Lower:  $V_{\text{DRAIN}}$ , 200 V, 10 ms/div.

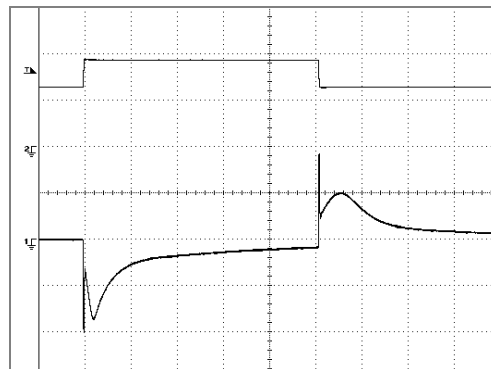


**11.4 Load Transient Response (75% to 100% Load Step)**

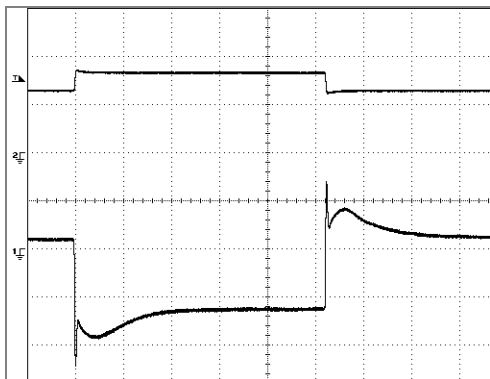
In the figures shown below, signal averaging was used to better enable viewing the load transient response. The oscilloscope was triggered using the load current step as a trigger source. Since the output switching and line frequency occur essentially at random with respect to the load transient, contributions to the output ripple from these sources will average out, leaving the contribution only from the load step response.



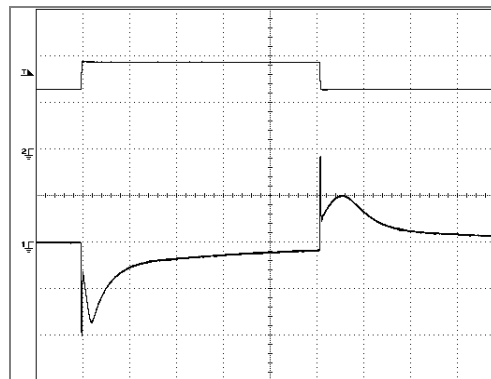
**Figure 20** - 115 VAC Transient Response.  
75%-100%-75% Load Step.  
Top: Load Current, 2 A/div.  
Bottom: Voltage at Supply Output  
100 mV, 500  $\mu$ s/div.



**Figure 21** - 230 VAC Transient Response.  
75%-100%-75% Load Step.  
Top: Load Current, 2 A/div.  
Bottom: Voltage at Supply Output  
100 mV, 1 ms/div.



**Figure 22** - 115 VAC Transient Response.  
75%-100%-75% Load Step  
at End of Cable.  
Top: Load Current, 2 A/div.  
Bottom: Voltage at End of Cable  
100 mV, 500  $\mu$ s/div.



**Figure 23** - 230 VAC Transient Response  
75%-100%-75% Load Step  
at End of Cable.  
Top: Load Current, 2 A/div.  
Bottom: Voltage at End of Cable  
100 mV, 1 ms/div.

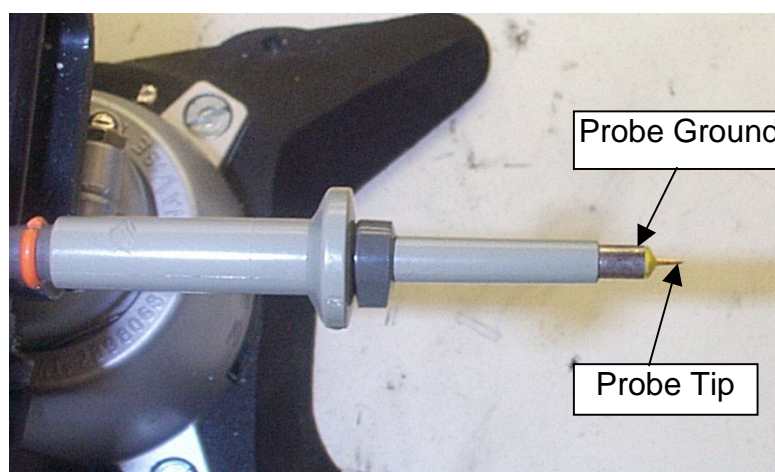


## 11.5 Output Ripple Measurements

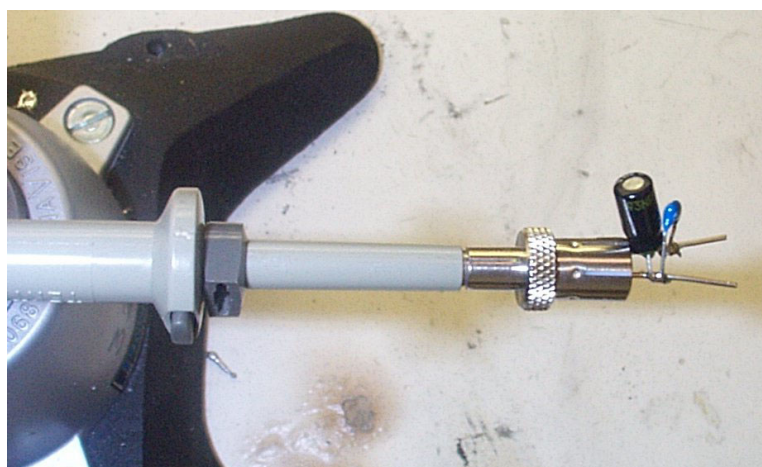
### 11.5.1 Ripple Measurement Technique

For DC output ripple measurements, a modified oscilloscope test probe must be utilized in order to reduce spurious signals due to pickup. Details of the probe modification are provided in Figure 24 and Figure 25.

The 5125BA probe adapter is affixed with two capacitors tied in parallel across the probe tip. The capacitors include one (1) 0.1  $\mu\text{F}/50\text{ V}$  ceramic type and one (1) 1.0  $\mu\text{F}/50\text{ V}$  aluminum electrolytic. **The aluminum electrolytic type capacitor is polarized, so proper polarity across DC outputs must be maintained (see below).**

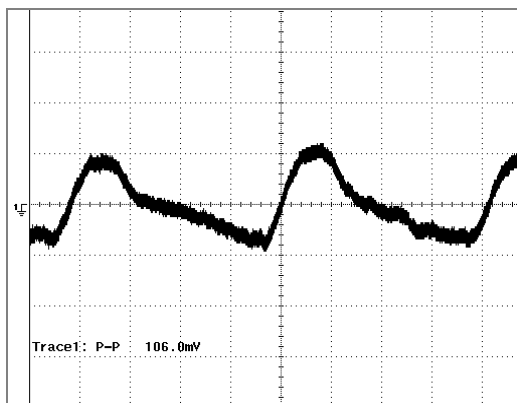


**Figure 24** - Oscilloscope Probe Prepared for Ripple Measurement (End Cap and Ground Lead Removed).

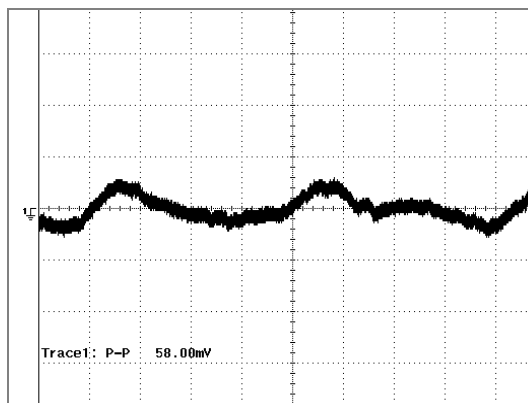


**Figure 25** - Oscilloscope Probe with Probe Master 5125BA BNC Adapter (Modified with wires for probe ground for ripple measurement and two parallel decoupling capacitors added).

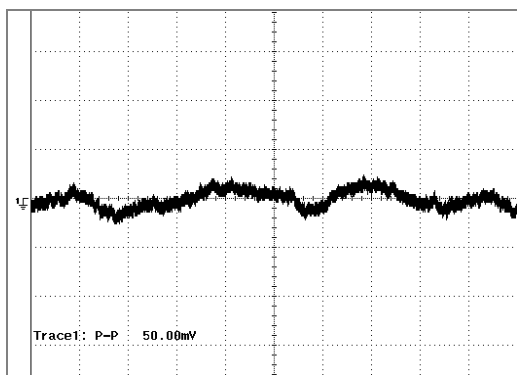
11.5.2 Measurement Results



**Figure 26** - Ripple, 90 VAC, Full Load at End of Cable.  
2 ms, 50 mV/div.



**Figure 27** - Ripple, 115 VAC, Full Load at End of Cable.  
2 ms, 50 mV/div.



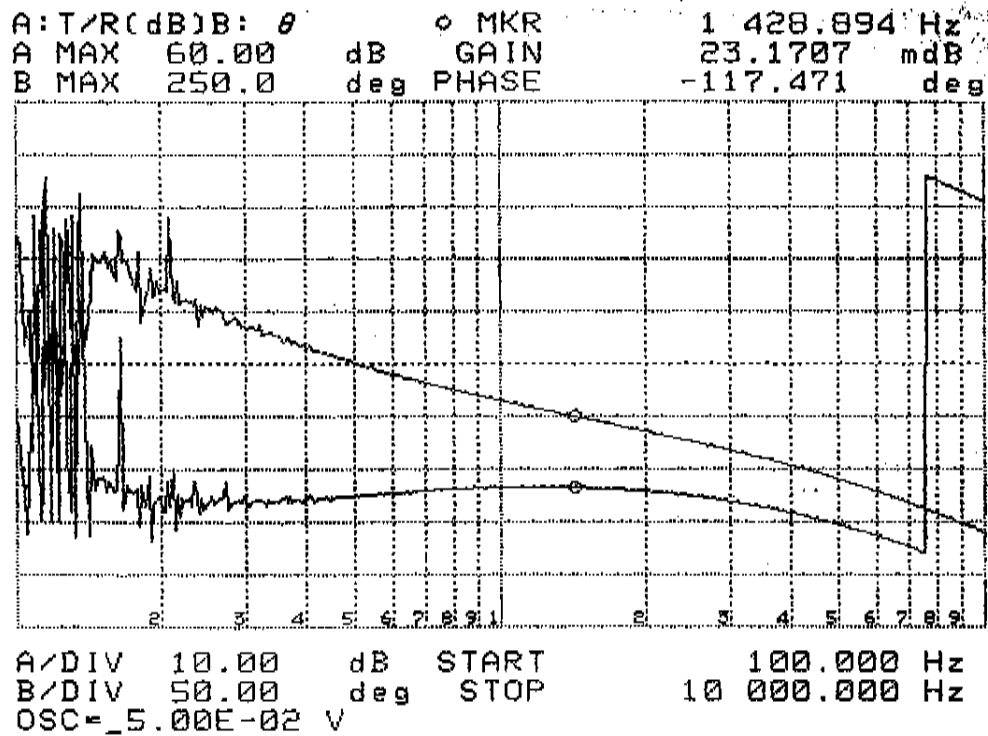
**Figure 28** - Ripple, 230 VAC, Full Load at End of Cable.  
2 ms, 50 mV/div.





## 12 Control Loop Measurements

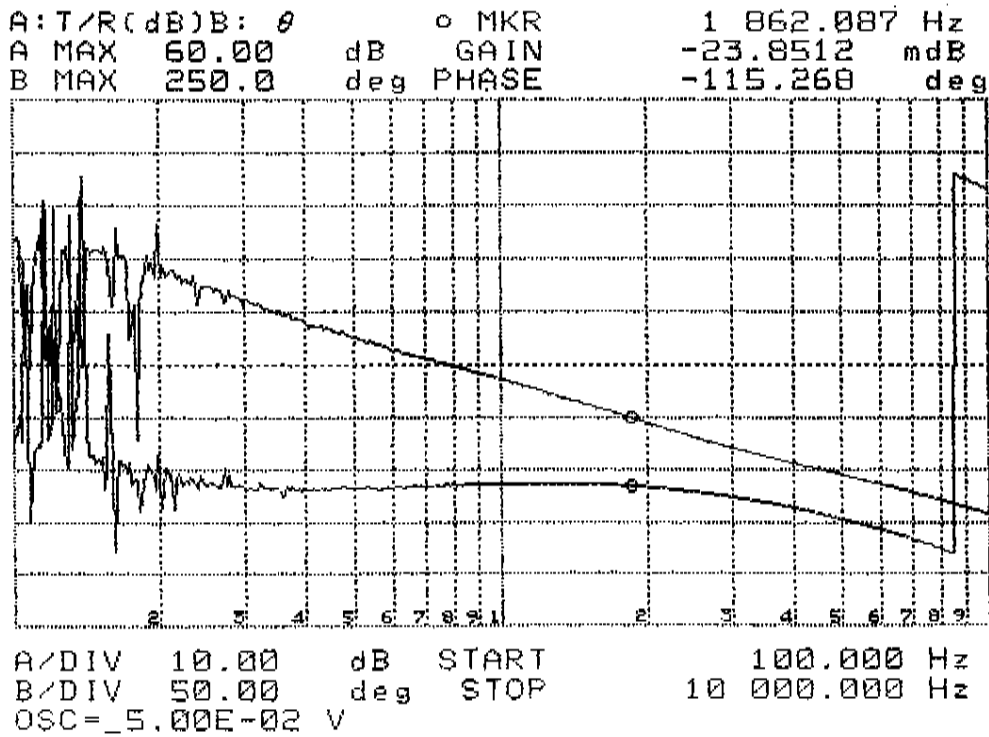
### 12.1 115 VAC Maximum Load



**Figure 29** - Gain-Phase Plot, 115 VAC, Maximum Steady State Load.  
 Vertical Scale: Gain = 10 dB/div., Phase = 50°/div.  
**Crossover Frequency** – 1.43 kHz, Phase Margin - 62.6°



12.2 230 VAC Maximum Load



**Figure 30** - Gain-Phase Plot, 230 VAC, Maximum Steady State Load.  
Vertical Scale: Gain = 10 dB/div., Phase = 50°/div.  
**Crossover Frequency** - 1.86 kHz, Phase Margin – 64.7°



### 13 Conducted EMI

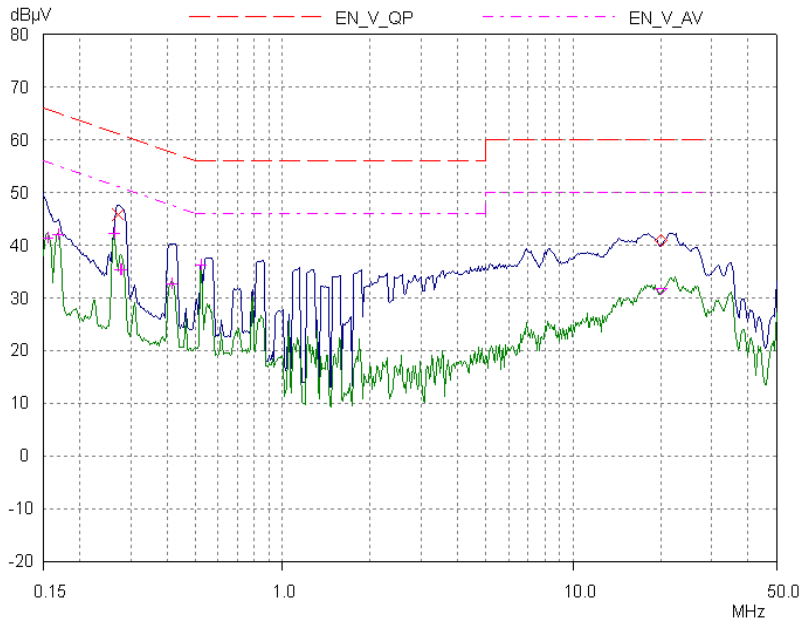


Figure 31 - Conducted EMI, Maximum Steady State Load, 115 VAC, 60 Hz, and EN55022 B Limits.

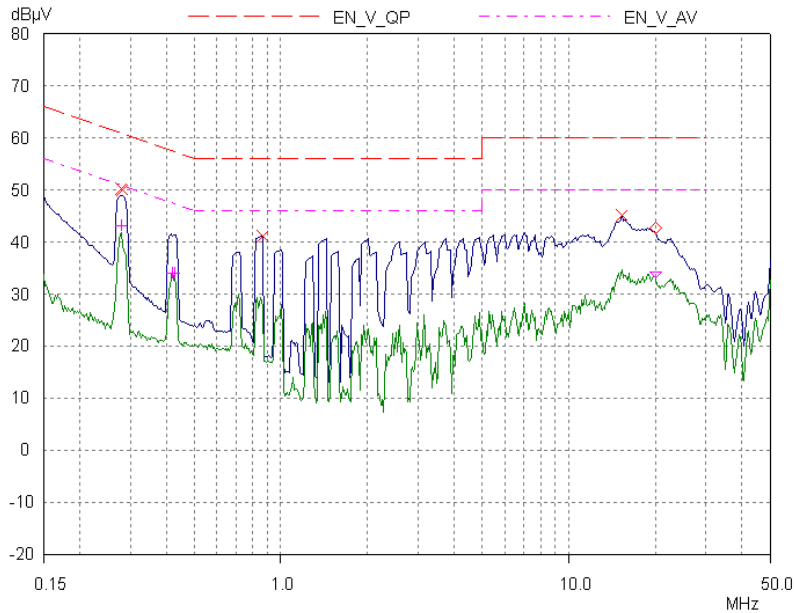


Figure 32 - Conducted EMI, Maximum Steady State Load, 230 VAC, 60 Hz, and EN55022 B Limits.

Conducted EMI was measured with output return connected to ground of LISN.



## 14 AC Surge and 100 kHz Ring Wave Immunity

Four series of line transient tests were performed on the EP-33 to determine the level of immunity attainable for the basic board. Testing was performed using a Keytek EMC-Pro surge generator. The input voltage for the supply under test was 230 VAC, and the supply was resistively loaded to the maximum continuous output power. The UUT secondary return was hard wired to the surge generator earth connection to simulate use in an actual system. An LED was used to monitor the presence of output voltage and to detect output interruptions. The test for each series was terminated upon non-destructive interruption of output voltage, arcing, or non-recoverable interruption of output voltage. A test failure was defined as a non-recoverable interruption of output voltage requiring supply repair or recycling of input AC voltage.

### 14.1 Common Mode Surge, 1.2/50 $\mu$ sec

Surge Voltage	Phase Angle (°)	Generator Impedance	Number of Strikes	Test Result
1 kV	0	12 $\Omega$	10	Pass
1 kV	90	12 $\Omega$	10	Pass
1 kV	270	12 $\Omega$	10	Pass
2 kV	0	12 $\Omega$	10	Pass
2 kV	90	12 $\Omega$	10	Pass
2 kV	270	12 $\Omega$	10	Pass
2.5 kV	0	12 $\Omega$	10	Pass
2.5 kV	90	12 $\Omega$	10	Pass
2.5 kV	270	12 $\Omega$	10	Pass
3 kV	0	12 $\Omega$	10	Pass (1 interruption/10 strikes, supply recovered)
3 kV	90	12 $\Omega$	10	Pass (1 interruption/10 strikes, supply recovered)
3 kV	270	12 $\Omega$	10	Pass

### 14.2 Differential Mode Surge, 1.2/50 $\mu$ sec

Surge Voltage	Phase Angle (°)	Generator Impedance	Number of Strikes	Test Result
1 kV	0	12 $\Omega$	10	Pass
1 kV	90	12 $\Omega$	10	Pass
1 kV	270	12 $\Omega$	10	Pass
2 kV	0	12 $\Omega$	10	Pass
2 kV	90	12 $\Omega$	10	Pass
2 kV	270	12 $\Omega$	10	Pass
3 kV	0	12 $\Omega$	10	Pass
3 kV	90	12 $\Omega$	10	Pass
3 kV	270	12 $\Omega$	10	Pass
4 kV	0	12 $\Omega$	10	Pass
4 kV	90	12 $\Omega$	10	Pass
4 kV	270	12 $\Omega$	10	Pass



**14.3 Common Mode, 100 kHz Ring Wave**

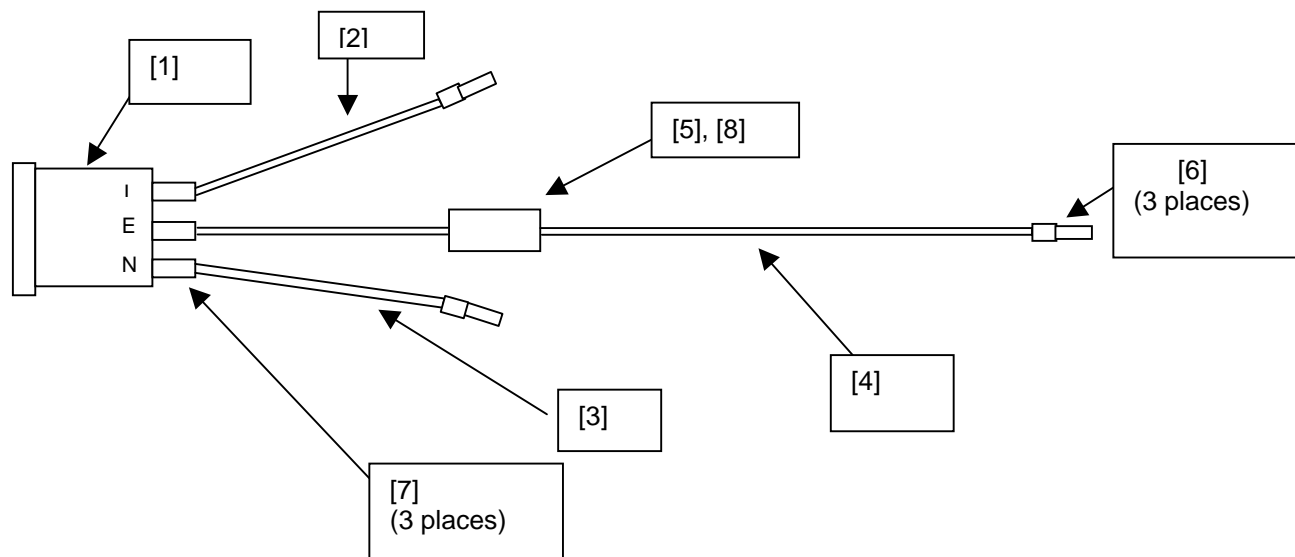
Surge Voltage (kV)	Phase Angle (°)	Short Circuit Current	Number of Strikes	Test Result
1 kV	0	500 A	10	Pass
1 kV	90	500 A	10	Pass
1 kV	270	500 A	10	Pass
2 kV	0	500 A	10	Pass
2 kV	90	500 A	10	Pass
2 kV	270	500 A	10	Pass
3 kV	0	500 A	10	Pass
3 kV	90	500 A	10	Pass
3 kV	270	500 A	10	Pass
4 kV	0	500 A	1	Pass (Supply arcing, no power interruption)

**14.4 Differential Mode, 100 kHz Ring Wave**

Surge Voltage	Phase Angle (°)	Short Circuit Current	Number of Strikes	Test Result
1 kV	0	500 A	10	Pass
1 kV	90	500 A	10	Pass
1 kV	270	500 A	10	Pass
2 kV	0	500 A	10	Pass
2 kV	90	500 A	10	Pass
2 kV	270	500 A	10	Pass
3 kV	0	500 A	10	Pass
3 kV	90	500 A	10	Pass
3 kV	270	500 A	10	Pass
4 kV	0	500 A	10	Pass
4 kV	90	500 A	10	Pass
4 kV	270	500 A	10	Pass



## 15 Appendix



### 15.1 Input Cable Bill of Materials

EP-33 Input Assy Rev.2, 11/18/02  
 Bill Of Materials

Item	Qty	Reference	Description	P/N	Manufacturer
1	1	J1	Input Receptacle	701W-X2/02	Qualtek
2	A/R		Wire, 18 AWG, UL 1007, Black, 0.08" dia		
3	A/R		Wire, 18 AWG, UL 1007, White, 0.08" dia.		
4	A/R		Wire, 18 AWG, UL 1007, Grn/Yel, 0.08" dia		
5	1	L5	Ferrite Bead	2643006302	Fair-Rite
6	3		Board-in Terminal	02-07-2102	Molex
7	A/R		Heat Shrink 3/16", UL VW-1	FIT221V-3/16	Alpha
8	A/R		Heat Shrink, FIT221V-1/2	Alpha	

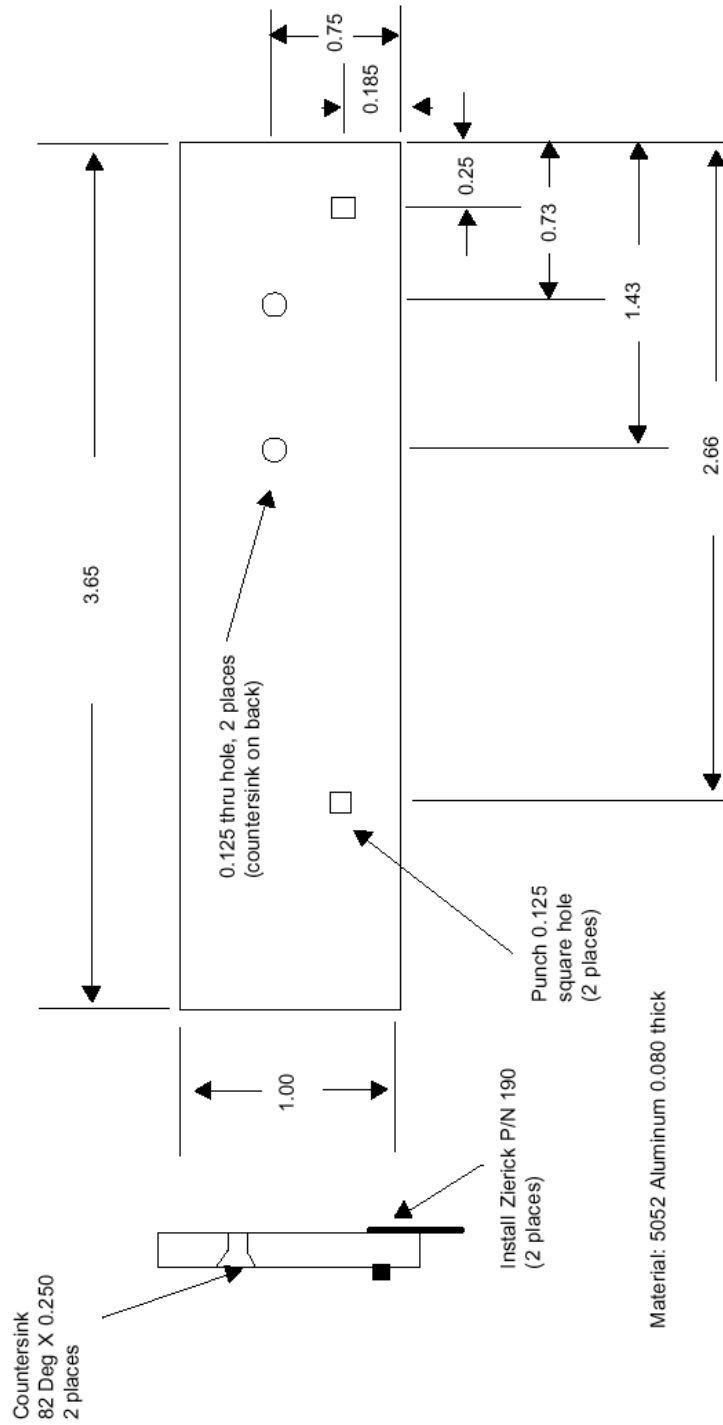
### 15.2 Input Cable Assembly

- 1) Cut 1 each 2" length items [2] and [3]. Strip 0.25" each end
- 2) Crimp 1 piece item [6] on one end of each wire.
- 3) Cut one 12 " piece item [4]
- 4) Center 1 piece item [5] on item [4] cut length, wind 3 turns item [4] on item [5].
- 5) Trim one end item [4]. [5] assembly to 1.5", other end to 4". Strip both ends 0.25".
- 6) Crimp one piece item [6] on 4" end of item [4], [5] assembly.
- 7) Cut 3/4" length item [8], slide over item [4], [5] assembly so that it is centered on item [5], shrink in place.
- 8) Solder remaining stripped ends of wires to receptacle [1] as shown, insulate each connection using 0.5" item [7].



### 15.3 Heat Sink Assembly

EP33 Heat Sink, Rev. 3 11/11/02



## 16 Revision History

Date	Author	Revision	Description & changes
18-Nov-2002	RH	0.1	First draft
22-Nov-2002	RH	0.2	Second Draft
06-Dec-02	RH	0.3	Third Draft
28-Mar-03	RH	1.0	First Release

For the latest updates, visit our Web site: [www.powerint.com](http://www.powerint.com)

### PATENT INFORMATION

Power Integrations reserves the right to make changes to its products at any time to improve reliability or manufacturability. Power Integrations does not assume any liability arising from the use of any device or circuit described herein, nor does it convey any license under its patent rights or the rights of others.

The products and applications illustrated herein (including circuits external to the products and transformer construction) may be covered by one or more U.S. and foreign patents or potentially by pending U.S. and foreign patent applications assigned to Power Integrations. A complete list of Power Integrations' patents may be found at [www.powerint.com](http://www.powerint.com).

The PI Logo, **TOPSwitch**, **TinySwitch**, **LinkSwitch**, and **EcoSmart** are registered trademarks of Power Integrations, Inc. **PI Expert** and **DPA-Switch** are trademarks of Power Integrations, Inc.  
© Copyright 2003, Power Integrations, Inc.

#### WORLD HEADQUARTERS NORTH AMERICA - WEST

Power Integrations, Inc.  
5245 Hellyer Avenue  
San Jose, CA 95138 USA.  
Main: +1-408-414-9200  
Customer Service:  
Phone: +1-408-414-9665  
Fax: +1-408-414-9765  
e-mail:  
[usasales@powerint.com](mailto:usasales@powerint.com)

#### CHINA

Power Integrations  
International Holdings, Inc.  
Rm# 1705, Block A  
Bao Hua Bldg.  
1016 Hua Qiang Bei Lu  
Shenzhen Guangdong,  
518031  
Phone: +86-755-8367-5143  
Fax: +86-755-8377-9610  
e-mail:  
[chinasales@powerint.com](mailto:chinasales@powerint.com)

#### APPLICATIONS HOTLINE

World Wide +1-408-414-9660

#### EUROPE & AFRICA

Power Integrations (Europe) Ltd.  
Centennial Court  
Easthampstead Road  
Bracknell  
Berkshire RG12 1YQ,  
United Kingdom  
Phone: +44-1344-462-300  
Fax: +44-1344-311-732  
e-mail: [eurosales@powerint.com](mailto:eurosales@powerint.com)

#### KOREA

Power Integrations  
International Holdings, Inc.  
Rm# 402, Handuk Building,  
649-4 Yeoksam-Dong,  
Kangnam-Gu,  
Seoul, Korea  
Phone: +82-2-568-7520  
Fax: +82-2-568-7474  
e-mail: [koreasales@powerint.com](mailto:koreasales@powerint.com)

#### APPLICATIONS FAX

World Wide +1-408-414-9760

#### SINGAPORE

Power Integrations, Singapore  
51 Goldhill Plaza #16-05  
Republic of Singapore,  
308900  
Phone: +65-6358-2160  
Fax: +65-6358-2015  
e-mail:  
[singaporesales@powerint.com](mailto:singaporesales@powerint.com)

#### JAPAN

Power Integrations, K.K.  
Keihin-Tatemono 1st Bldg.  
12-20 Shin-Yokohama  
2-Chome,  
Kohoku-ku, Yokohama-shi,  
Kanagawa 222-0033, Japan  
Phone: +81-45-471-1021  
Fax: +81-45-471-3717  
e-mail:  
[japansales@powerint.com](mailto:japansales@powerint.com)

#### TAIWAN

Power Integrations  
International Holdings, Inc.  
17F-3, No. 510  
Chung Hsiao E. Rd.,  
Sec. 5,  
Taipei, Taiwan 110, R.O.C.  
Phone: +886-2-2727-1221  
Fax: +886-2-2727-1223  
e-mail:  
[taiwansales@powerint.com](mailto:taiwansales@powerint.com)

#### INDIA (Technical Support)

Innovatech  
#1, 8th Main Road  
Vasanthnagar  
Bangalore, India 560052  
Phone: +91-80-226-6023  
Fax: +91-80-228-9727  
e-mail:  
[indiasales@powerint.com](mailto:indiasales@powerint.com)

