

## Open Carrier Frequency Doubler For Microwave Telecommunications

**FDC2310**  
V1

### Features

- Input Frequency 1.5 to 8.0 GHz
- Output Frequency 3.0 to 16.0 GHz
- Input Drive Level +10 dBm (nominal)
- Microstrip Interface

### Description

The FDC2310 is a passive bridge diode frequency doubler, designed for use in military, commercial and test equipment applications. The design utilizes Schottky bridge quad diodes and broadband soft dielectric baluns to attain excellent performance. Environmental screening available to MIL-STD-883, MIL-STD-202, or MIL-DTL-28837, consult factory.

### Product Image

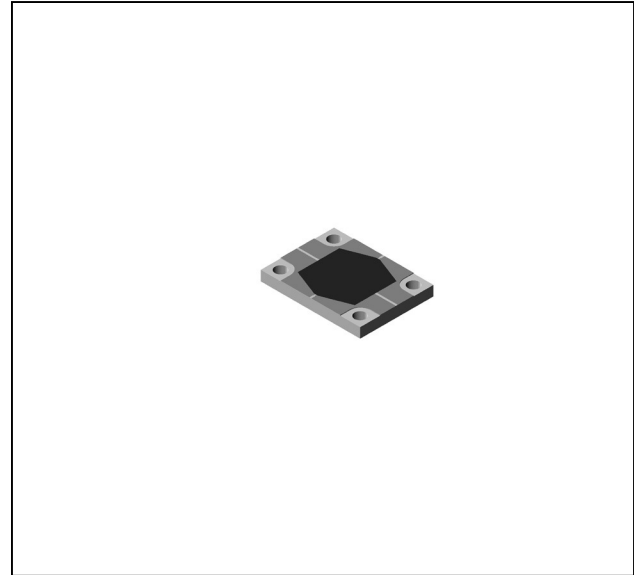

### Ordering Information

Part Number	Package
FDC2310	Open Carrier

### Electrical Specifications: $Z_0 = 50\Omega$ $P_{in} = +10$ dBm

Parameter	Test Conditions	Units	Typical	Guaranteed	
				+25°C	-40° to +85°C
SSB Conversion Loss (max)	$f_{in} = 1.5$ to 8.0 GHz	dB	11	14.0	14.5
Fundamental Suppression (min)	$f_{in} = 1.5$ to 8.0 GHz	dBc	35	19.5	19
Third Harmonic Suppression (min)	$f_{in} = 1.5$ to 8.0 GHz	dBc	40	20	18
Input VSWR	$f_{in} = 1.5$ to 8.0 GHz		2.0:1		

**Open Carrier Frequency Doubler  
For Microwave Telecommunications**

**FDC2310**  
V1

**Typical Performance Curves**

**Conversion Loss**

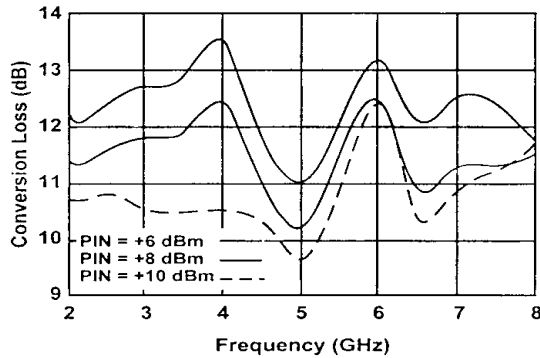

**Conversion Loss**

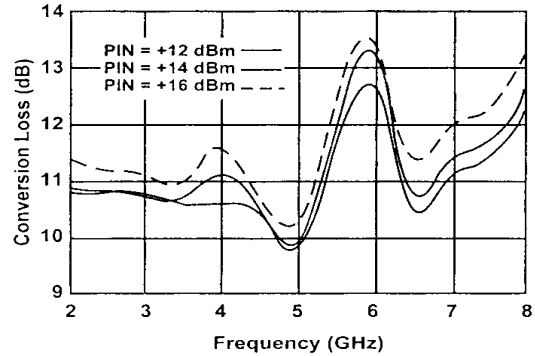

**Input VSWR**

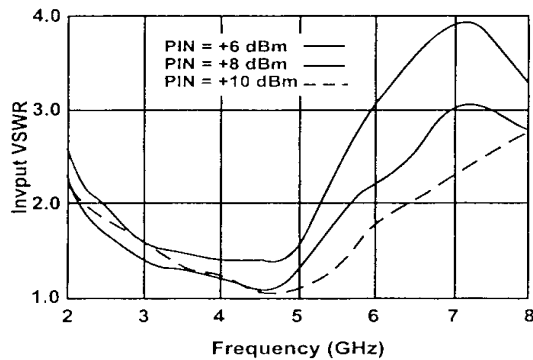

**Input VSWR**

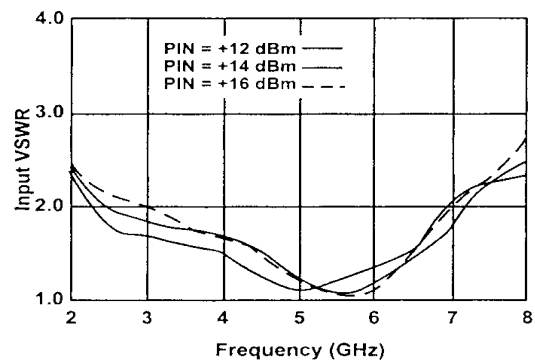

**Fundamental Suppression**

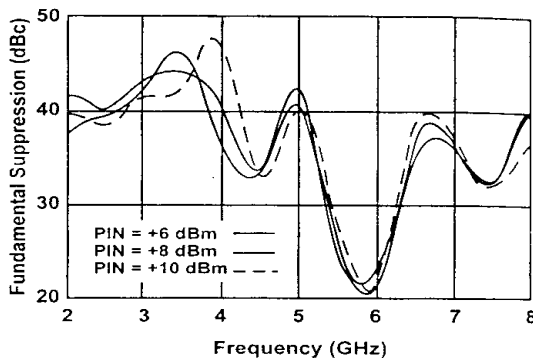

**Fundamental Suppression**

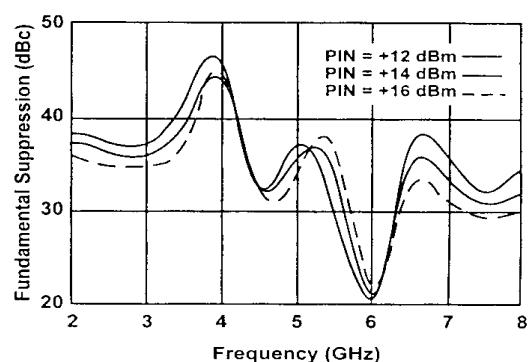

**Open Carrier Frequency Doubler  
For Microwave Telecommunications**

**FDC2310**  
V1

**Absolute Maximum Ratings**

Parameter	Absolute Maximum
Operating Temperature	-54°C to +100°C
Storage Temperature	-65°C to +100°C
Peak Input Power	+23 dBm max @ +25°C +20 dBm max @ +100°C
Peak Input Current	50 mA DC

**Outline Drawing: Open Carrier \***

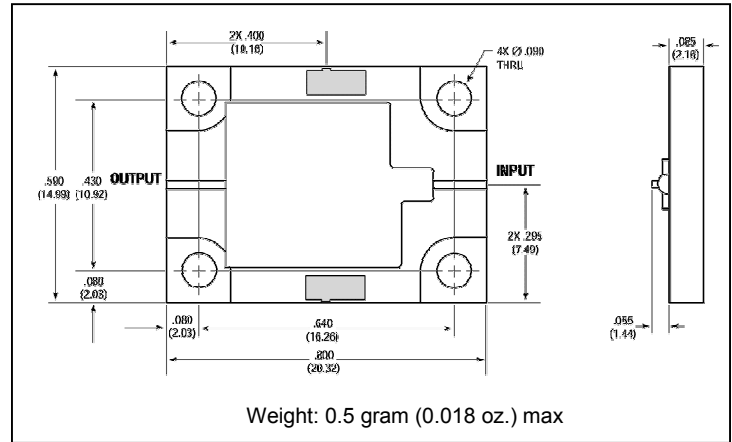

\* Dimensions are inches (millimeters) ±0.015 (0.38) unless otherwise specified.

**Third Harmonic Suppression**

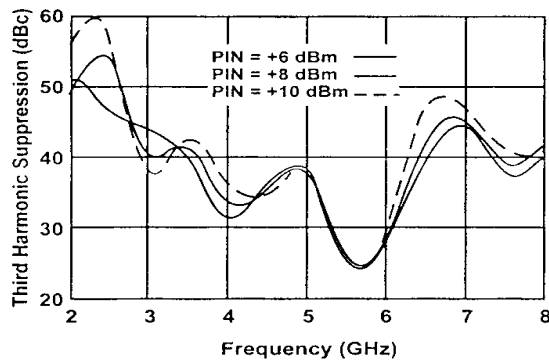

**Third Harmonic Suppression**

