

FDJ1027P

P-Channel 1.8V Specified PowerTrench® MOSFET

Features

- -2.8 A, -20 V $R_{DS(ON)} = 160\text{ m}\Omega @ V_{GS} = -4.5\text{ V}$
 $R_{DS(ON)} = 230\text{ m}\Omega @ V_{GS} = -2.5\text{ V}$
 $R_{DS(ON)} = 390\text{ m}\Omega @ V_{GS} = -1.8\text{ V}$
- Low gate charge, High Power and Current handling capability
- High performance trench technology for extremely low $R_{DS(ON)}$
- FLMP SC75 package: Enhanced thermal performance in industry-standard package size

General Description

This dual P-Channel 1.8V specified MOSFET uses Fairchild's advanced low voltage PowerTrench process. Packaged in FLMP SC75, the $R_{DS(ON)}$ and thermal properties of the device are optimized for battery power management applications.

Applications

- Battery management/Charger Application
- Load switch

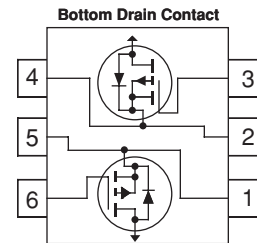
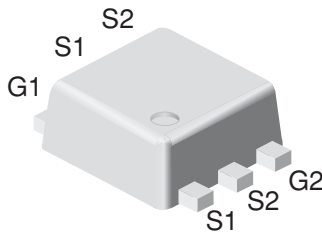

MOSFET Maximum Ratings $T_A=25^\circ\text{C}$ unless otherwise noted

| Symbol | Parameter | Ratings | Units |
|--------------------------------|---|-------------|---------------------------|
| V_{DSS} | Drain-Source Voltage | -20 | V |
| V_{GSS} | Gate-Source Voltage | ± 8 | V |
| I_D | Drain Current – Continuous (Note 1a) | -2.8 | A |
| | | – Pulsed | |
| P_D | Power Dissipation for Single Operation (Note 1a) | 1.5 | W |
| | | (Note 1b) | |
| T_J, T_{stg} | Operating and Storage Junction Temperature Range | -55 to +150 | $^\circ\text{C}$ |
| Thermal Characteristics | | | |
| $R_{\theta JA}$ | Thermal Resistance, Junction-to-Ambient (Note 1a) | 80 | $^\circ\text{C}/\text{W}$ |
| $R_{\theta JC}$ | Thermal Resistance, Junction-to-Case | 5 | |

Package Marking and Ordering Information

| | | | | |
|----|----------|----|-----|------------|
| .G | FDJ1027P | 7" | 8mm | 3000 units |
|----|----------|----|-----|------------|

Electrical Characteristics $T_A = 25^\circ\text{C}$ unless otherwise noted

| Symbol | Parameter | Test Conditions | Min | Typ | Max | Units |
|---|---|---|------|--------------------------|--------------------------|----------------------|
| Off Characteristics | | | | | | |
| BV_{DSS} | Drain-Source Breakdown Voltage | $V_{GS} = 0\text{ V}, I_D = -250\ \mu\text{A}$ | -20 | | | V |
| $\frac{\Delta BV_{DSS}}{\Delta T_J}$ | Breakdown Voltage Temperature Coefficient | $I_D = -250\ \mu\text{A}$, Referenced to 25°C | | -13 | | mV/ $^\circ\text{C}$ |
| I_{DSS} | Zero Gate Voltage Drain Current | $V_{DS} = -16\text{ V}, V_{GS} = 0\text{ V}$ | | | -1 | μA |
| I_{GSS} | Gate-Body Leakage | $V_{GS} = \pm 8\text{ V}, V_{DS} = 0\text{ V}$ | | | ± 100 | nA |
| On Characteristics (Note 2) | | | | | | |
| $V_{GS(th)}$ | Gate Threshold Voltage | $V_{DS} = V_{GS}, I_D = -250\ \mu\text{A}$ | -0.4 | -0.8 | -1.5 | V |
| $\frac{\Delta V_{GS(th)}}{\Delta T_J}$ | Gate Threshold Voltage Temperature Coefficient | $I_D = -250\ \mu\text{A}$, Referenced to 25°C | | 3 | | mV/ $^\circ\text{C}$ |
| $R_{DS(on)}$ | Static Drain-Source On-Resistance | $V_{GS} = -4.5\text{ V}, I_D = -2.8\text{ A}$ $V_{GS} = -2.5\text{ V}, I_D = -2.2\text{ A}$ $V_{GS} = -1.8\text{ V}, I_D = -1.7\text{ A}$ $V_{GS} = -4.5\text{ V}, I_D = -2.8\text{ A}, T_J = 125^\circ\text{C}$ | | 108 163 283 150 | 160 230 390 238 | m Ω |
| g_{FS} | Forward Transconductance | $V_{DS} = -5\text{ V}, I_D = -2.8\text{ A}$ | | 5 | | S |
| Dynamic Characteristics | | | | | | |
| C_{iss} | Input Capacitance | $V_{DS} = -10\text{ V}, V_{GS} = 0\text{ V},$ $f = 1.0\text{ MHz}$ | | 290 | | pF |
| C_{oss} | Output Capacitance | | | 55 | | pF |
| C_{rss} | Reverse Transfer Capacitance | | | 29 | | pF |
| R_g | Gate Resistance | $f = 1.0\text{ MHz}$ | | 13 | | Ω |
| Switching Characteristics (Note 2) | | | | | | |
| $t_{d(on)}$ | Turn-On Delay Time | $V_{DD} = -10\text{ V}, I_D = -1\text{ A},$ $V_{GS} = -4.5\text{ V}, R_{GEN} = 6\ \Omega$ | | 8 | 16 | ns |
| t_r | Turn-On Rise Time | | | 13 | 23 | ns |
| $t_{d(off)}$ | Turn-Off Delay Time | | | 13 | 23 | ns |
| t_f | Turn-Off Fall Time | | | 18 | 32 | ns |
| Q_g | Total Gate Charge | $V_{DS} = -10\text{ V}, I_D = -2.8\text{ A},$ $V_{GS} = -4.5\text{ V}$ | | 3 | 4 | nC |
| Q_{gs} | Gate-Source Charge | | | 0.65 | | nC |
| Q_{gd} | Gate-Drain Charge | | | 0.75 | | nC |
| Drain-Source Diode Characteristics and Maximum Ratings | | | | | | |
| I_S | Maximum Continuous Drain-Source Diode Forward Current | | | | -1.25 | A |
| V_{SD} | Drain-Source Diode Forward Voltage | $V_{GS} = 0\text{ V}, I_S = -1.25\text{ A}$ (Note 2) | | -0.8 | -1.2 | V |
| t_{rr} | Diode Reverse Recovery Time | $I_F = -2.8\text{ A},$ $d_{IF}/d_t = 100\text{ A}/\mu\text{s}$ | | 14 | | ns |
| Q_{rr} | Diode Reverse Recovery Charge | | | 4 | | nC |

Notes:

- $R_{\theta JA}$ is the sum of the junction-to-case and case-to-ambient thermal resistance where the case thermal reference is defined as the solder mounting surface of the drain pins. $R_{\theta JC}$ is guaranteed by design while $R_{\theta CA}$ is determined by the user's board design.



a) 80°C/W when mounted on a 1 in^2 pad of 2 oz copper (Single Operation).

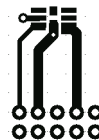

b) 140°C/W when mounted on a minimum pad of 2 oz copper (Single Operation).

Scale 1 : 1 on letter size paper

- Pulse Test: Pulse Width < $300\ \mu\text{s}$, Duty Cycle < 2.0%

Typical Characteristics

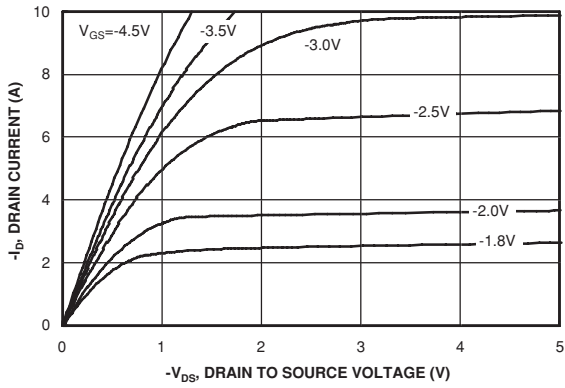

Figure 1. On-Region Characteristics.

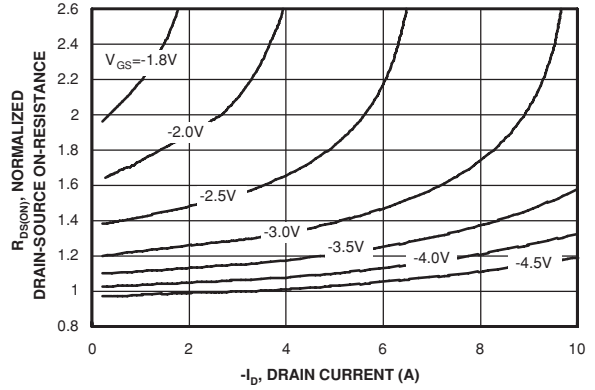

Figure 2. On-Resistance Variation with Drain Current and Gate Voltage.

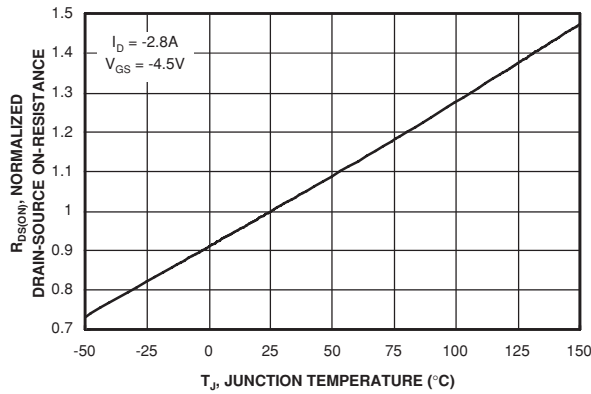

Figure 3. On-Resistance Variation with Temperature.

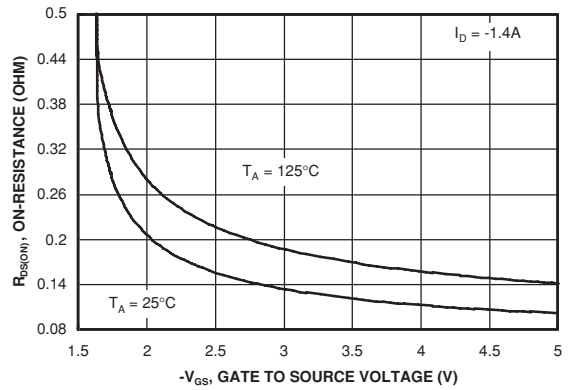

Figure 4. On-Resistance Variation with Gate-to-Source Voltage.

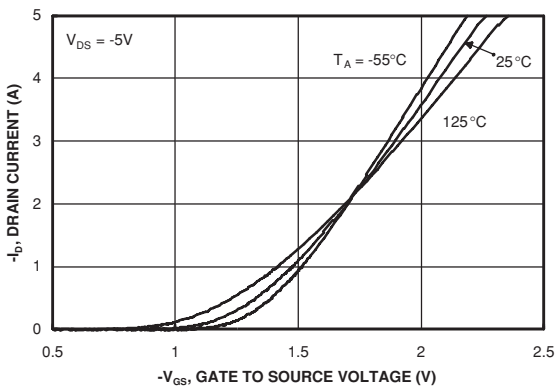

Figure 5. Transfer Characteristics.

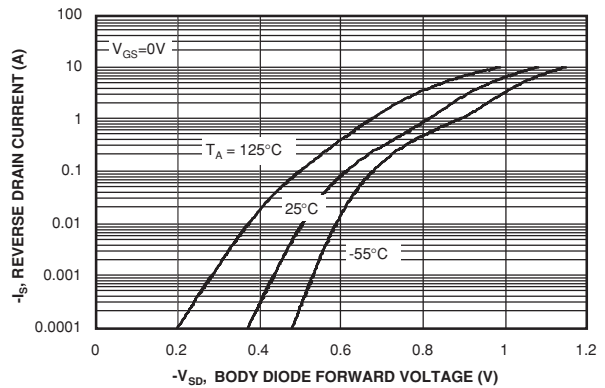

Figure 6. Body Diode Forward Voltage Variation with Source Current and Temperature.

Typical Characteristics

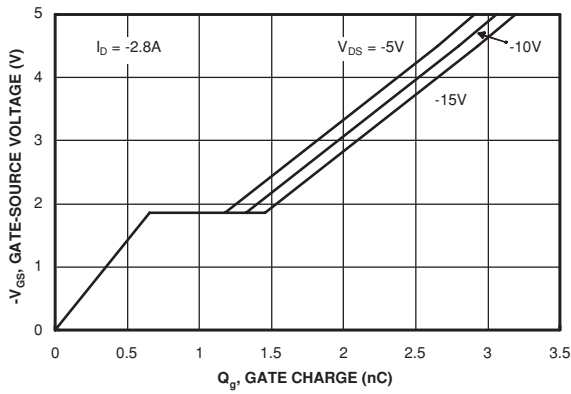

Figure 7. Gate Charge Characteristics.

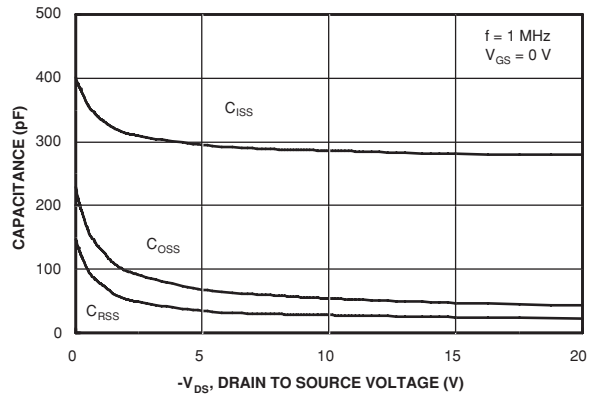

Figure 8. Capacitance Characteristics.

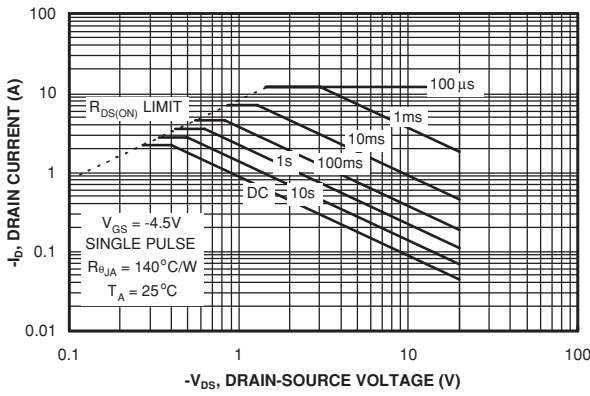

Figure 9. Maximum Safe Operating Area.

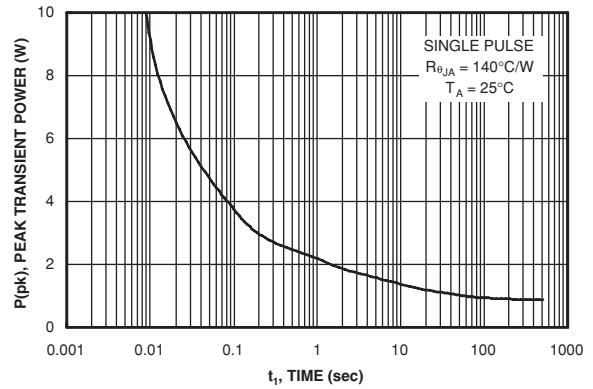

Figure 10. Single Pulse Maximum Power Dissipation.

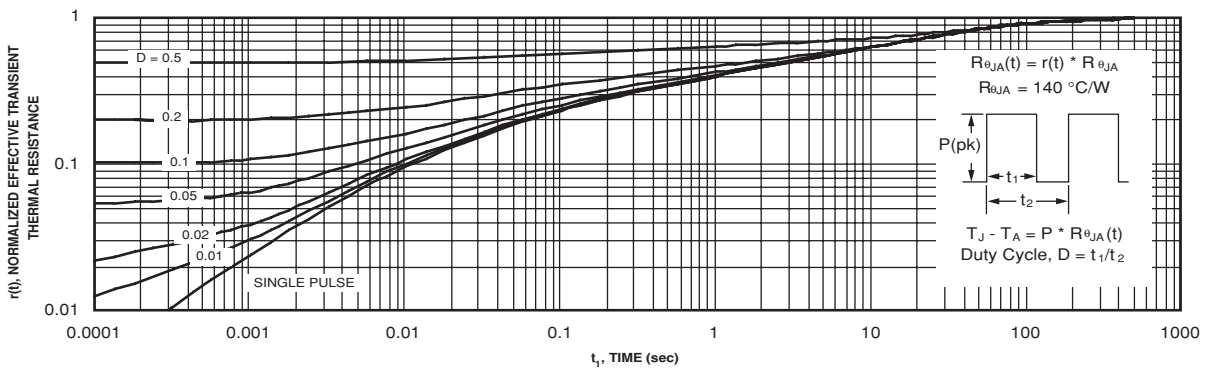
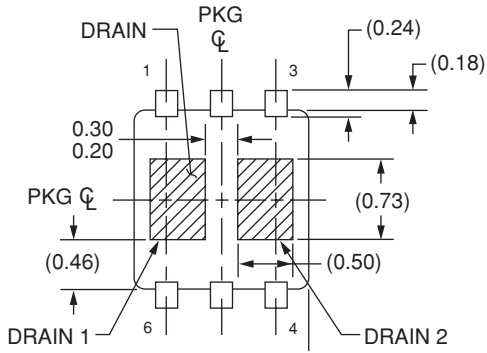

Figure 11. Transient Thermal Response Curve.

Thermal characterization performed using the conditions described in Note 1b.
Transient thermal response will change depending on the circuit board design.

Dimensional Outline and Pad Layout



Bottom View

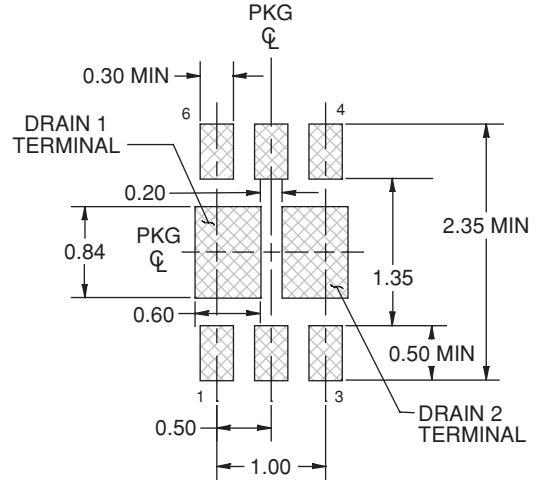

Recommended Landing Pattern

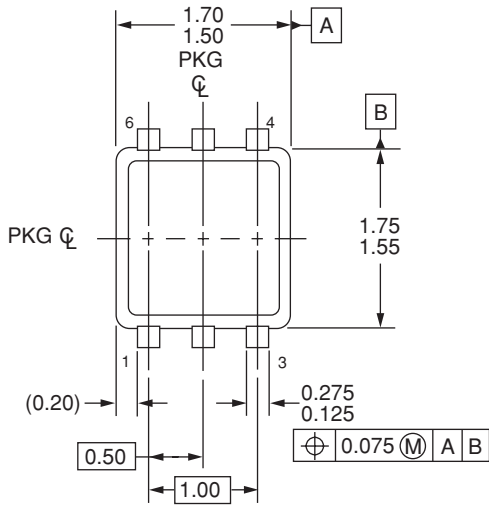

Top View

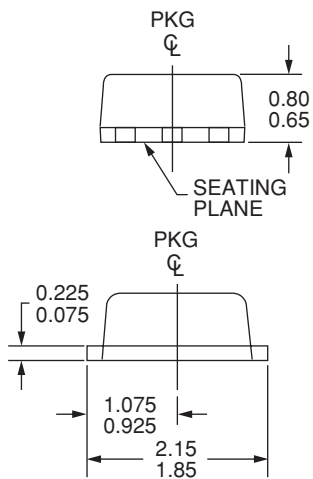

TRADEMARKS

The following are registered and unregistered trademarks Fairchild Semiconductor owns or is authorized to use and is not intended to be an exhaustive list of all such trademarks.

| | | | | |
|---|----------------------------------|----------------------------------|------------------------------|-----------------------|
| ACE ^x TM | FACT Quiet Series TM | OCX TM | SILENT SWITCHER [®] | UniFET TM |
| ActiveArray TM | GlobalOptoisolator TM | OCXPro TM | SMART START TM | UltraFET [®] |
| Bottomless TM | GTO TM | OPTOLOGIC [®] | SPM TM | VCX TM |
| Build it Now TM | HiSeC TM | OPTOPLANAR TM | Stealth TM | Wire TM |
| CoolFET TM | I ² C TM | PACMAN TM | SuperFET TM | |
| CROSSVOLT TM | <i>i-Lo</i> TM | POP TM | SuperSOT TM -3 | |
| DOMET TM | ImpliedDisconnect TM | Power247 TM | SuperSOT TM -6 | |
| EcoSPARK TM | IntelliMAX TM | PowerEdge TM | SuperSOT TM -8 | |
| E ² CMOS TM | ISOPLANAR TM | PowerSaver TM | SyncFET TM | |
| EnSigna TM | LittleFET TM | PowerTrench [®] | TCM TM | |
| FACT TM | MICROCOUPLER TM | QFET [®] | TinyBoost TM | |
| FAST [®] | MicroFET TM | QS TM | TinyBuck TM | |
| FAST _r TM | MicroPak TM | QT Optoelectronics TM | TinyPWM TM | |
| FPS TM | MICROWIRE TM | Quiet Series TM | TinyPower TM | |
| FRFET TM | MSX TM | RapidConfigure TM | TinyLogic [®] | |
| | MSXPro TM | RapidConnect TM | TINYOPTO TM | |
| Across the board. Around the world. TM | | μSerDes TM | TruTranslation TM | |
| The Power Franchise [®] | | ScalarPump TM | UHC TM | |
| Programmable Active Droop TM | | | | |

DISCLAIMER

FAIRCHILD SEMICONDUCTOR RESERVES THE RIGHT TO MAKE CHANGES WITHOUT FURTHER NOTICE TO ANY PRODUCTS HEREIN TO IMPROVE RELIABILITY, FUNCTION, OR DESIGN. FAIRCHILD DOES NOT ASSUME ANY LIABILITY ARISING OUT OF THE APPLICATION OR USE OF ANY PRODUCT OR CIRCUIT DESCRIBED HEREIN; NEITHER DOES IT CONVEY ANY LICENSE UNDER ITS PATENT RIGHTS, NOR THE RIGHTS OF OTHERS. THESE SPECIFICATIONS DO NOT EXPAND THE TERMS OF FAIRCHILD'S WORLDWIDE TERMS AND CONDITIONS, SPECIFICALLY THE WARRANTY THEREIN, WHICH COVERS THESE PRODUCTS.

LIFE SUPPORT POLICY

FAIRCHILD'S PRODUCTS ARE NOT AUTHORIZED FOR USE AS CRITICAL COMPONENTS IN LIFE SUPPORT DEVICES OR SYSTEMS WITHOUT THE EXPRESS WRITTEN APPROVAL OF FAIRCHILD SEMICONDUCTOR CORPORATION.

As used herein:

- Life support devices or systems are devices or systems which, (a) are intended for surgical implant into the body, or (b) support or sustain life, or (c) whose failure to perform when properly used in accordance with instructions for use provided in the labeling, can be reasonably expected to result in significant injury to the user.
- A critical component is any component of a life support device or system whose failure to perform can be reasonably expected to cause the failure of the life support device or system, or to affect its safety or effectiveness.

PRODUCT STATUS DEFINITIONS

Definition of Terms

| Datasheet Identification | Product Status | Definition |
|--------------------------|------------------------|--|
| Advance Information | Formative or In Design | This datasheet contains the design specifications for product development. Specifications may change in any manner without notice. |
| Preliminary | First Production | This datasheet contains preliminary data, and supplementary data will be published at a later date. Fairchild Semiconductor reserves the right to make changes at any time without notice to improve design. |
| No Identification Needed | Full Production | This datasheet contains final specifications. Fairchild Semiconductor reserves the right to make changes at any time without notice to improve design. |
| Obsolete | Not In Production | This datasheet contains specifications on a product that has been discontinued by Fairchild semiconductor. The datasheet is printed for reference information only. |