

PRELIMINARY
 Notice: This is not a final specification.
 Some parametric limits are subject to change.

MITSUBISHI Nch POWER MOSFET

FL12KM-12A

HIGH-SPEED SWITCHING USE

FL12KM-12A

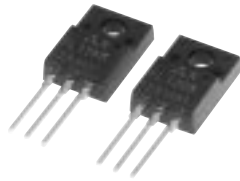

- 10V DRIVE
- V_{DSS} 600V
- r_{DS (ON)} (MAX) 0.94Ω
- I_D 12A

OUTLINE DRAWING

Dimensions in mm

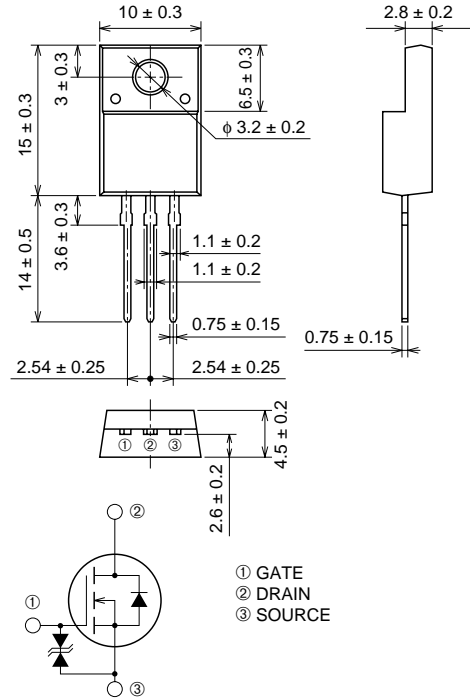

TO-220FN

APPLICATION

Switch mode power supply, Inverter fluorescent lamp, etc.

MAXIMUM RATINGS (T_c = 25°C)

Symbol	Parameter	Conditions	Ratings	Unit
V _{DSS}	Drain-source voltage	V _{GS} = 0V	600	V
V _{GSS}	Gate-source voltage	V _{DS} = 0V	±30	V
I _D	Drain current		12	A
I _{DM}	Drain current (Pulsed)		36	A
I _{DA}	Avalanche drain current (Pulsed)	L = 200μH	12	A
P _D	Maximum power dissipation		40	W
T _{ch}	Channel temperature		-55 ~ +150	°C
T _{stg}	Storage temperature		-55 ~ +150	°C
V _{iso}	Isolation voltage	AC for 1minute, Terminal to case	2000	V
—	Weight	Typical value	2.0	g

PRELIMINARY
 Notice: This is not a final specification.
 Some parametric limits are subject to change.

ELECTRICAL CHARACTERISTICS (Tch = 25°C)

Symbol	Parameter	Test conditions	Limits			Unit
			Min.	Typ.	Max.	
V (BR) DSS	Drain-source breakdown voltage	ID = 1mA, VGS = 0V	600	—	—	V
V (BR) GSS	Gate-source breakdown voltage	IGS = ±100µA, VDS = 0V	±30	—	—	V
IGSS	Gate-source leakage current	VGS = ±25V, VDS = 0V	—	—	±10	µA
IDSS	Drain-source leakage current	VDS = 600V, VGS = 0V	—	—	1	mA
VGS (th)	Gate-source threshold voltage	ID = 1mA, VDS = 10V	2.0	3.0	4.0	V
rDS (ON)	Drain-source on-state resistance	ID = 6A, VGS = 10V	—	0.80	0.94	Ω
VDS (ON)	Drain-source on-state voltage	ID = 6A, VGS = 10V	—	4.80	5.64	V
yfs	Forward transfer admittance	ID = 6A, VDS = 10V	—	8.0	—	S
Ciss	Input capacitance	VDS = 25V, VGS = 0V, f = 1MHz	—	1250	—	pF
Coss	Output capacitance		—	150	—	pF
Crss	Reverse transfer capacitance		—	55	—	pF
td (on)	Turn-on delay time	VDD = 200V, ID = 6A, VGS = 10V, RGEN = RGS = 50Ω	—	25	—	ns
tr	Rise time		—	45	—	ns
td (off)	Turn-off delay time		—	250	—	ns
tf	Fall time		—	90	—	ns
VSD	Source-drain voltage	IS = 6A, VGS = 0V	—	1.5	2.0	V
Rth (ch-c)	Thermal resistance	Channel to case	—	—	3.13	°C/W

PERFORMANCE CURVES

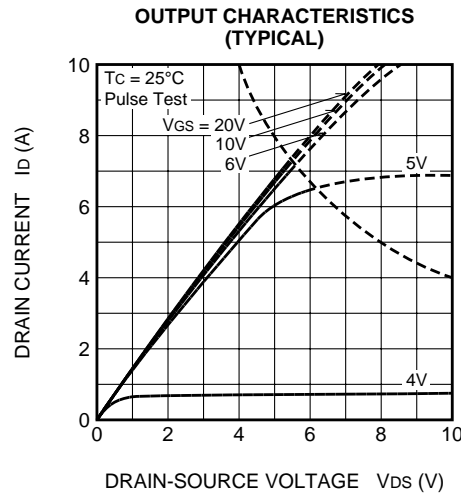
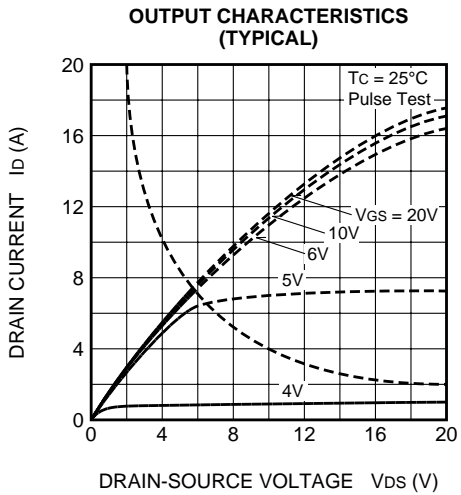
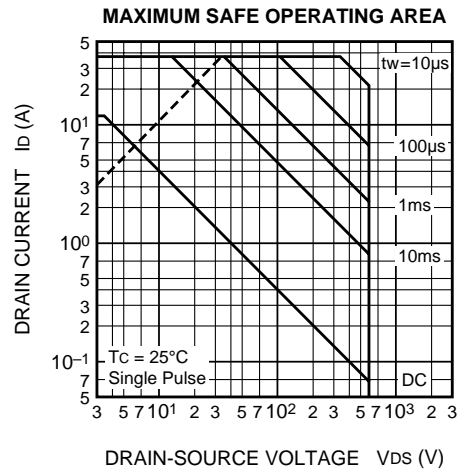
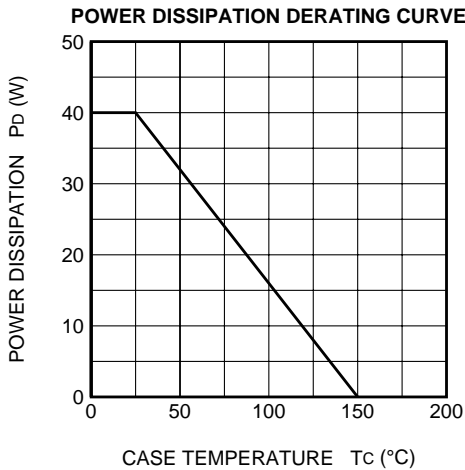

PRELIMINARY
 Notice: This is not a final specification.
 Some parametric limits are subject to change.

ON-STATE VOLTAGE VS. GATE-SOURCE VOLTAGE (TYPICAL)

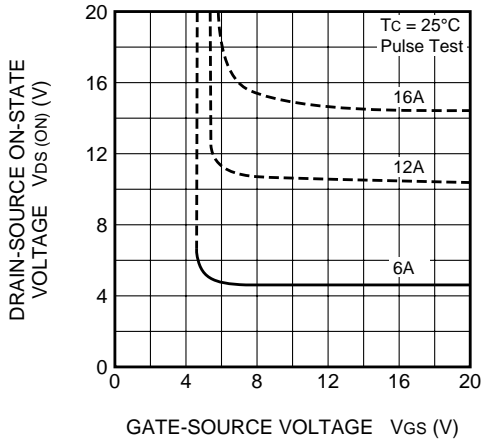

ON-STATE RESISTANCE VS. DRAIN CURRENT (TYPICAL)

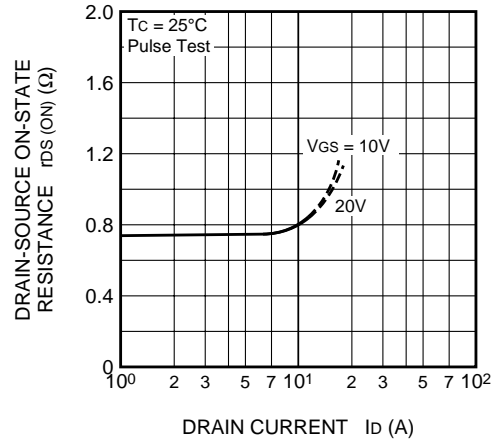

TRANSFER CHARACTERISTICS (TYPICAL)

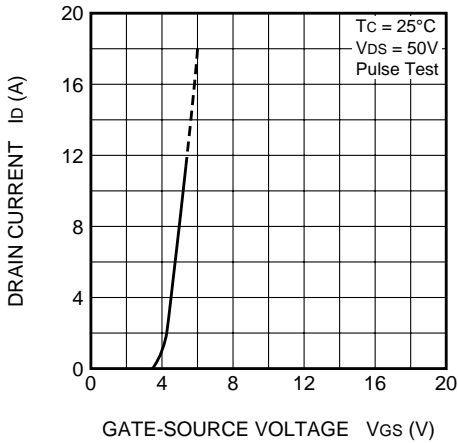

FORWARD TRANSFER ADMITTANCE VS. DRAIN CURRENT (TYPICAL)

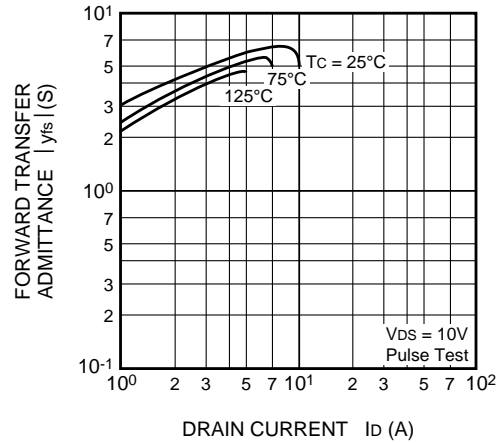

CAPACITANCE VS. DRAIN-SOURCE VOLTAGE (TYPICAL)

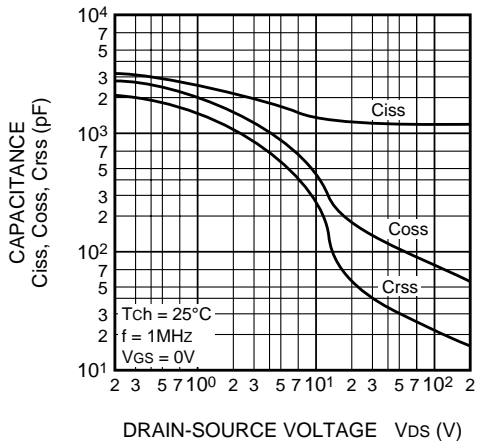

SWITCHING CHARACTERISTICS (TYPICAL)

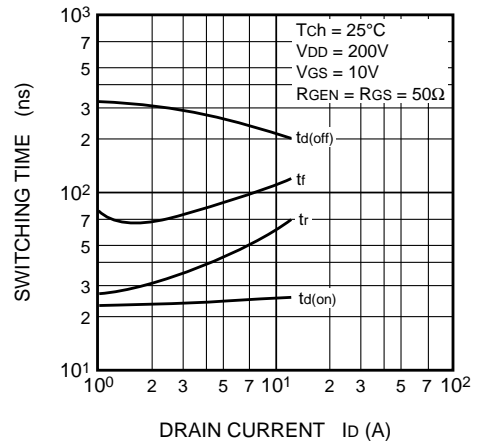

PRELIMINARY
 Notice: This is not a final specification.
 Some parametric limits are subject to change.

GATE-SOURCE VOLTAGE VS. GATE CHARGE (TYPICAL)

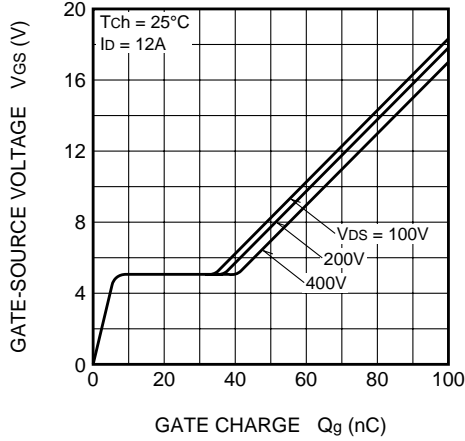

SOURCE-DRAIN DIODE FORWARD CHARACTERISTICS (TYPICAL)

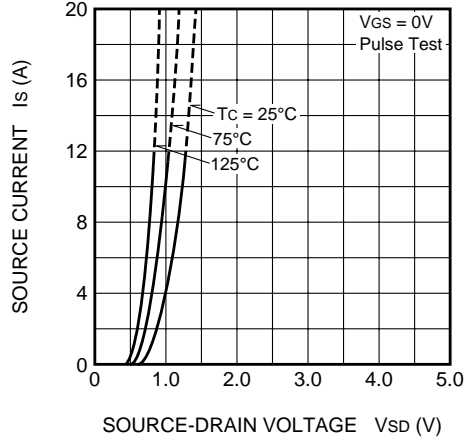

ON-STATE RESISTANCE VS. CHANNEL TEMPERATURE (TYPICAL)

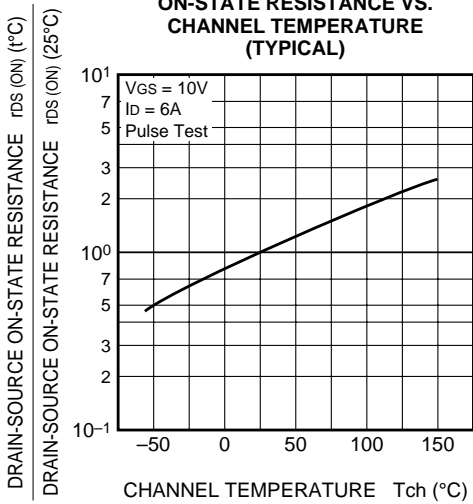

THRESHOLD VOLTAGE VS. CHANNEL TEMPERATURE (TYPICAL)

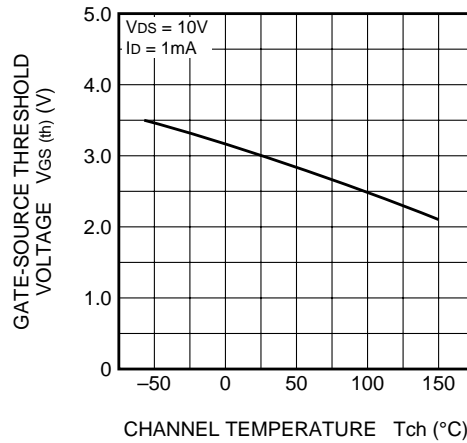

BREAKDOWN VOLTAGE VS. CHANNEL TEMPERATURE (TYPICAL)

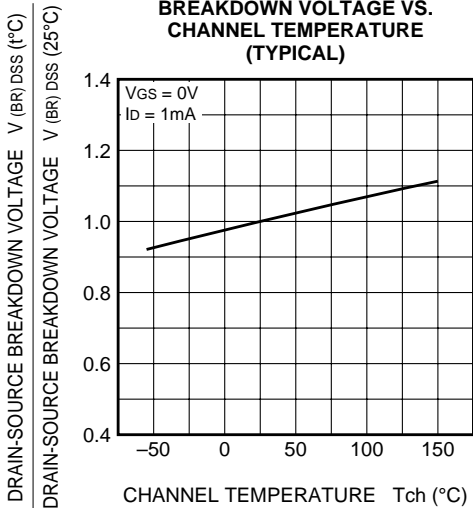

TRANSIENT THERMAL IMPEDANCE CHARACTERISTICS

