

MITSUBISHI Nch POWER MOSFET

FY6ACJ-03A

HIGH-SPEED SWITCHING USE

FY6ACJ-03A

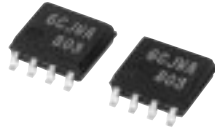

- 4V DRIVE
- V_{DSS} 30V
- $r_{DS(ON)}(MAX)$ 23m Ω
- I_D 6A

OUTLINE DRAWING

Dimensions in mm

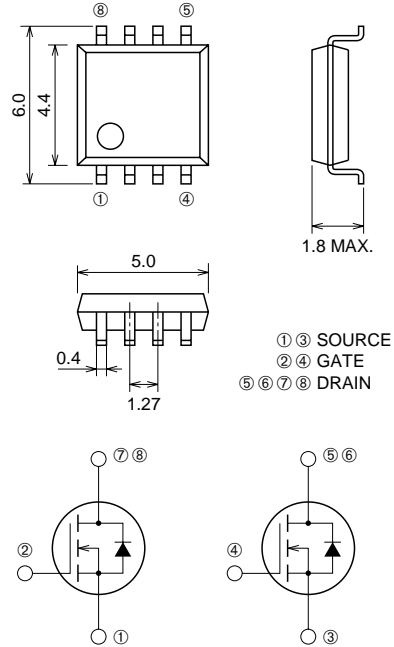

SOP-8

APPLICATION

Motor control, Lamp control, Solenoid control
DC-DC converter, etc.

MAXIMUM RATINGS (Tc = 25°C)

Symbol	Parameter	Conditions	Ratings	Unit
V_{DSS}	Drain-source voltage	$V_{GS} = 0V$	30	V
V_{GSS}	Gate-source voltage	$V_{DS} = 0V$	± 20	V
I_D	Drain current		6	A
I_{DM}	Drain current (Pulsed)		42	A
I_{DA}	Avalanche drain current (Pulsed)	$L = 10\mu H$	6	A
I_S	Source current		1.7	A
I_{SM}	Source current (Pulsed)		6.8	A
P_D	Maximum power dissipation		1.8	W
T_{ch}	Channel temperature		-55 ~ +150	°C
T_{stg}	Storage temperature		-55 ~ +150	°C
—	Weight	Typical value	0.07	g

Sep.1998

ELECTRICAL CHARACTERISTICS (Tch = 25°C)

Symbol	Parameter	Test conditions	Limits			Unit
			Min.	Typ.	Max.	
V(BR)DSS	Drain-source breakdown voltage	Id = 1mA, VGS = 0V	30	—	—	V
IGSS	Gate-source leakage current	VGS = ±20V, VDS = 0V	—	—	±0.1	μA
IDSS	Drain-source leakage current	VDS = 30V, VGS = 0V	—	—	0.1	mA
VGS(th)	Gate-source threshold voltage	Id = 1mA, VDS = 10V	1.0	1.5	2.0	V
rDS(ON)	Drain-source on-state resistance	Id = 6A, VGS = 10V	—	17	23	mΩ
rDS(ON)	Drain-source on-state resistance	Id = 3A, VGS = 4V	—	26	40	mΩ
VDS(ON)	Drain-source on-state voltage	Id = 6A, VGS = 10V	—	102	138	mV
yfs	Forward transfer admittance	Id = 6A, VDS = 10V	—	12	—	S
Ciss	Input capacitance	VDS = 10V, VGS = 0V, f = 1MHz	—	1000	—	pF
Coss	Output capacitance		—	350	—	pF
Crss	Reverse transfer capacitance		—	160	—	pF
td(on)	Turn-on delay time	VDD = 15V, Id = 3A, VGS = 10V, RGEN = RGS = 50Ω	—	15	—	ns
tr	Rise time		—	25	—	ns
td(off)	Turn-off delay time		—	75	—	ns
tf	Fall time		—	55	—	ns
VSD	Source-drain voltage	IS = 1.7A, VGS = 0V	—	0.75	1.10	V
Rth(ch-a)	Thermal resistance	Channel to ambient	—	—	69.4	°C/W
trr	Reverse recovery time	IS = 1.7A, dis/dt = -50A/μs	—	35	—	ns

PERFORMANCE CURVES

POWER DISSIPATION DERATING CURVE

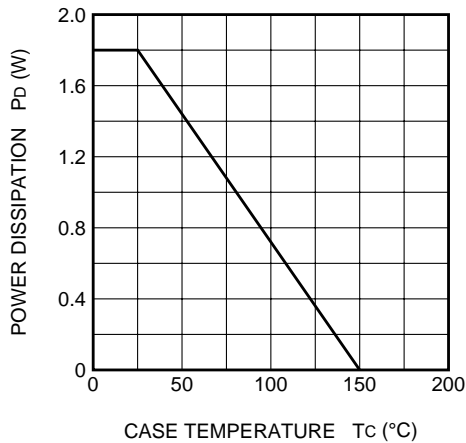

MAXIMUM SAFE OPERATING AREA

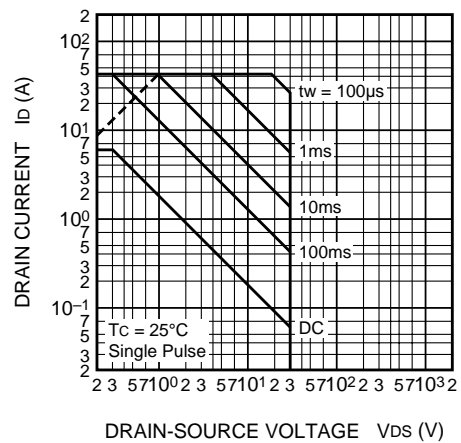

OUTPUT CHARACTERISTICS (TYPICAL)

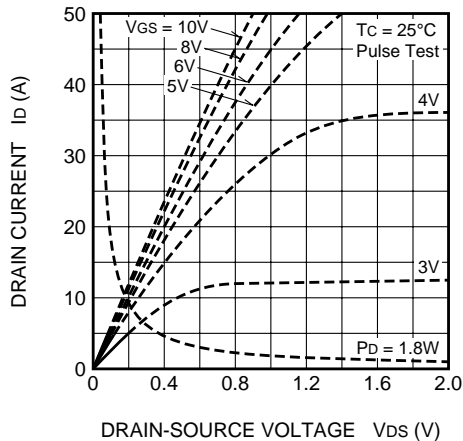

OUTPUT CHARACTERISTICS (TYPICAL)

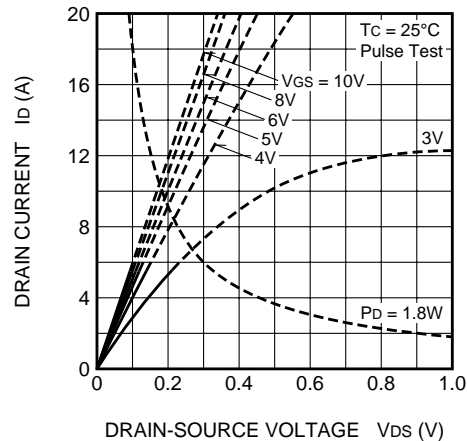

ON-STATE VOLTAGE VS. GATE-SOURCE VOLTAGE (TYPICAL)

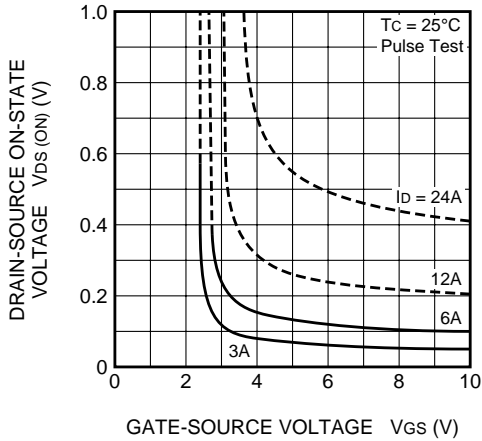

ON-STATE RESISTANCE VS. DRAIN CURRENT (TYPICAL)

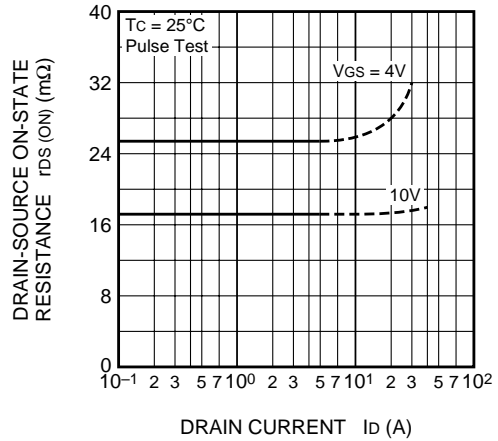

TRANSFER CHARACTERISTICS (TYPICAL)

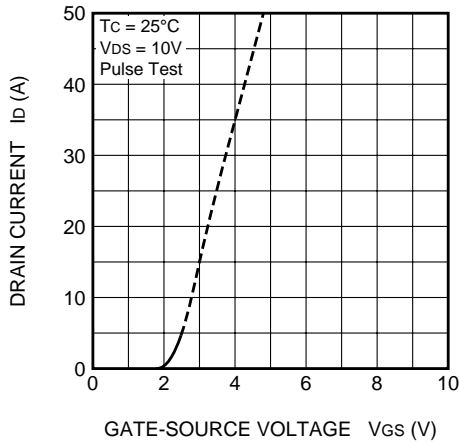

FORWARD TRANSFER ADMITTANCE VS. DRAIN CURRENT (TYPICAL)

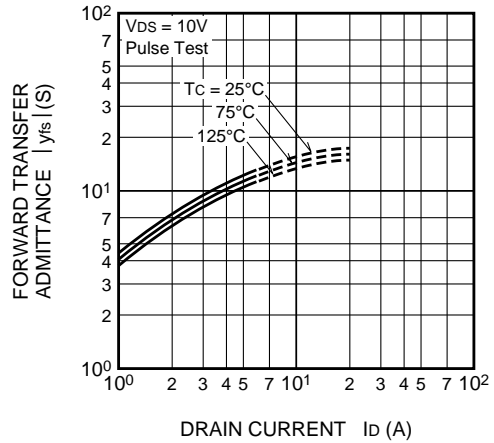

CAPACITANCE VS. DRAIN-SOURCE VOLTAGE (TYPICAL)

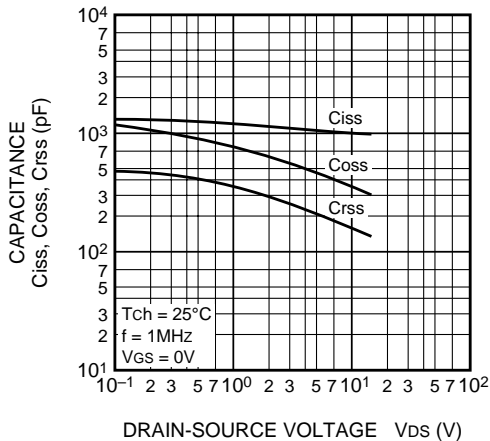

SWITCHING CHARACTERISTICS (TYPICAL)

