

IGBT PIM MODULE

Features

- Low V_{CE} (on) Non Punch Through IGBT Technology
- Low Diode VF
- 10µs Short Circuit Capability
- Square RBSOA
- HEXFRED Antiparallel Diode with Ultrasoft Diode Reverse Recovery Characteristics
- Positive V_{CE} (on) Temperature Coefficient
- Ceramic DBC Substrate
- Low Stray Inductance Design

Benefits

- Benchmark Efficiency for Motor Control
- Rugged Transient Performance
- Low EMI, Requires Less Snubbing
- Direct Mounting to Heatsink
- PCB Solderable Terminals
- Low Junction to Case Thermal Resistance
- UL Listed ①

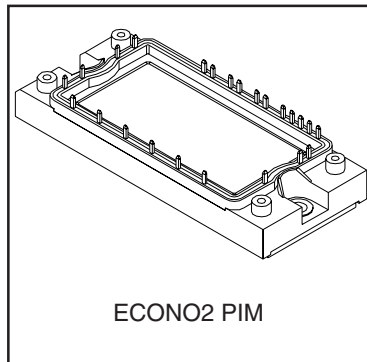

$V_{CES} = 1200V$

$I_C = 25A, T_C=80^{\circ}C$

$t_{sc} > 10\mu s, T_J=150^{\circ}C$

$V_{CE(on)} \text{ typ.} = 2.40V$

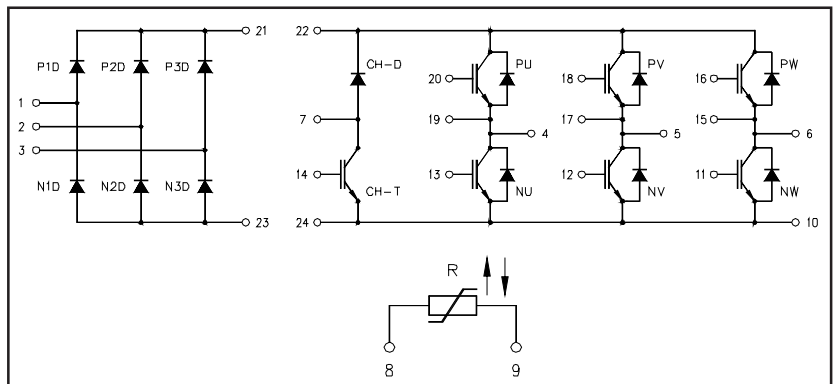

Absolute Maximum Ratings (T_J =25°C, unless otherwise indicated)

	Parameter	Symbol	Test Conditions	Ratings	Units	
Inverter	Collector-to-Emitter Voltage	V _{CES}		1200	V	
	Gate-to-Emitter Voltage	V _{GES}		±20		
	Collector Current	I _C	Continuous	25°C / 80°C	40 / 25	A
		I _{CM}		25°C	80	
	Diode Maximum Forward Current	I _{FM} ⊙		25°C	80	
Power Dissipation	P _D	1 device	25°C	198	W	
Input	Repetitive Peak Reverse Voltage	V _{RRM}		1600	V	
Rectifier	Average Output Current	I _{F(AV)}	50/60Hz sine pulse	80°C	20	A
	Surge Current (Non Repetitive)	I _{FSM}	Rated V _{RRM} applied, 10ms, sine pulse		250	
	i ² t (Non Repetitive)	i ² t			316	A ² s
Brake	Collector-to-Emitter Voltage	V _{CES}		1200	V	
	Gate-to-Emitter Voltage	V _{GES}		±20		
	Collector Current	I _C	Continuous	25°C / 80°C	25 / 15	A
		I _{CM}		25°C	50	
	Power Dissipation	P _D	1 device	25°C	104	W
	Repetitive Peak Reverse Voltage	V _{RRM}		1200	V	
	Maximum Operating Junction Temperature	T _J	—	—	150	°C
	Storage Temperature Range	T _{STG}	—	—	-40 to +125	
	Isolation Voltage	V _{ISOL}	AC(1min.)		2500	V

Thermal and Mechanical Characteristics

Parameter	Symbol	Min	Typical	Maximum	Units
Junction-to-Case Inverter IGBT Thermal Resistance	R _{THJC}	—	—	0.63	°C/W
Junction-to-Case Inverter FRED Thermal Resistance		—	—	1.0	
Junction-to-Case Brake IGBT Thermal Resistance		—	—	1.2	
Junction-to-Case Brake Diode Thermal Resistance		—	—	2.3	
Junction-to-Case Input Rectifier Thermal Resistance		—	—	0.85	
Mounting Torque (M5)		2.7	—	3.3	Nm

Electrical Characteristics @ $T_J = 25^\circ\text{C}$ (unless otherwise specified)

		Parameter	Min.	Typ.	Max.	Units	Conditions	
Inverter IGBT	BV_{CES}	Collector-to-Emitter Breakdown Voltage	1200	—	—	V	$V_{GE} = 0V, I_C = 500\mu A$	
	$\Delta V_{(BR)CES}/\Delta T_J$	Temperature Coeff. of Breakdown Voltage	—	1.0	—	V/ $^\circ\text{C}$	$V_{GE} = 0V, I_C = 1mA (25^\circ\text{C}-125^\circ\text{C})$	
	$V_{CE(on)}$	Collector-to-Emitter Voltage	—	2.40	2.70	V	$I_C = 25A, V_{GE} = 15V$	1,2
			—	2.95	3.30		$I_C = 40A, V_{GE} = 15V$	4,5
			—	2.85	—		$I_C = 25A, V_{GE} = 15V, T_J = 125^\circ\text{C}$	
			—	3.55	—		$I_C = 40A, V_{GE} = 15V, T_J = 125^\circ\text{C}$	
	$V_{GE(th)}$	Gate Threshold Voltage	4.0	5.0	6.0		$V_{CE} = V_{GE}, I_C = 250\mu A$	3,4,5
	$\Delta V_{GE(th)}$	Threshold Voltage temp. coefficient	—	-10	—	mV/ $^\circ\text{C}$	$V_{CE} = V_{GE}, I_C = 1mA (25^\circ\text{C}-125^\circ\text{C})$	
	I_{CES}	Zero Gate Voltage Collector Current	—	11	100	μA	$V_{GE} = 0V, V_{CE} = 1200V$	
			—	750	—		$V_{GE} = 0V, V_{CE} = 1200V, T_J = 125^\circ\text{C}$	
	I_{GES}	Gate-to-Emitter Leakage Current	—	—	± 200	nA	$V_{GE} = \pm 20V$	
	Q_g	Total Gate Charge (turn-on)	—	175	265	nC	$I_C = 25A$	7
	Q_{ge}	Gate-to-Emitter Charge (turn-on)	—	17.5	30		$V_{CC} = 400V$	CT1
	Q_{gc}	Gate-to-Collector Charge (turn-on)	—	81	125		$V_{GE} = 15V$	
	E_{on}	Turn-On Switching Loss	—	2450	4450	μJ	$I_C = 25A, V_{CC} = 600V$	CT4
	E_{off}	Turn-Off Switching Loss	—	2050	3200		$V_{GE} = 15V, R_G = 10\Omega, L = 400\mu H$	
	E_{tot}	Total Switching Loss	—	4500	7650		$T_J = 25^\circ\text{C} \textcircled{\text{C}}$	
	E_{on}	Turn-On Switching Loss	—	3350	5650	μJ	$I_C = 25A, V_{CC} = 600V$	9,11
	E_{off}	Turn-Off Switching Loss	—	2850	3850		$V_{GE} = 15V, R_G = 10\Omega, L = 400\mu H$	CT4
	E_{tot}	Total Switching Loss	—	6200	9500		$T_J = 125^\circ\text{C} \textcircled{\text{C}}$	WF1,2
	$t_{d(on)}$	Turn-On delay time	—	80	104	ns	$I_C = 25A, V_{CC} = 600V$	10,12
	t_r	Rise time	—	50	70		$V_{GE} = 15V, R_G = 10\Omega, L = 400\mu H$	CT4
	$t_{d(off)}$	Turn-Off delay time	—	510	1000		$T_J = 125^\circ\text{C}$	WF1
	t_f	Fall time	—	230	299			WF2
	C_{ies}	Input Capacitance	—	2370	—	pF	$V_{GE} = 0V$	6
	C_{oes}	Output Capacitance	—	455	—		$V_{CC} = 30V$	
	C_{res}	Reverse Transfer Capacitance	—	60	—		$f = 1.0\text{Mhz}$	
	RBSOA	Reverse Bias Safe Operating Area	FULL SQUARE				$T_J = 150^\circ\text{C}, I_C = 80A$ $R_G = 10\Omega, V_{GE} = +15V \text{ to } 0V$	CT2
	SCSOA	Short Circuit Safe Operating Area	10	—	—	μs	$T_J = 150^\circ\text{C}$ $V_{CC} = 900V, V_P = 1200V$ $R_G = 10\Omega, V_{GE} = +15V \text{ to } 0V$	CT3 WF4
Inverter FRED	I_{rr}	Diode Peak Reverse Recovery Current	—	35	—	A	$T_J = 125^\circ\text{C}$ $V_{CC} = 600V, I_F = 25A, L = 400\mu H$ $V_{GE} = 15V, R_G = 10\Omega$	13,14,15 CT4
	V_{FM}	Diode Forward Voltage Drop	—	1.90	2.35	V	$I_F = 25A$	8
—			2.25	2.80	$I_F = 40A$			
—			2.00	—	$I_F = 25A, T_J = 125^\circ\text{C}$			
—			2.45	—	$I_F = 40A, T_J = 125^\circ\text{C}$			

Electrical Characteristics @ T_J = 25°C (unless otherwise specified)

		Parameter	Min.	Typ.	Max.	Units	Conditions	
Input Rectifier	V _{FM}	Maximum Forward Voltage Drop	—	—	1.5	V	I _F = 25A	17
	I _{RM}	Maximum Reverse Leakage Current	—	—	0.1	mA	T _J = 25°C, V _R = 1600V	
			—	—	1.0		T _J = 150°C, V _R = 1600V	
	r _T	Forward Slope Resistance	—	—	10.4	mΩ	T _J = 150°C	
V _{F(TO)}	Conduction Threshold Voltage	—	—	0.85	V			
Brake IGBT	BV _{CES}	Collector-to-Emitter Breakdown Voltage	1200	—	—	V	V _{GE} = 0V, I _C = 500μA	
	ΔV _{(BR)CES/ΔT_J}	Temperature Coeff. of Breakdown Voltage	—	1.6	—	V/°C	V _{GE} = 0V, I _C = 1mA (25°C-125°C)	
	V _{CE(on)}	Collector-to-Emitter Voltage	—	2.30	2.50	V	I _C = 12.5A, V _{GE} = 15V	20,21
			—	3.00	3.25		I _C = 25A, V _{GE} = 15V	23,24
			—	2.70	—		I _C = 12.5A, V _{GE} = 15V, T _J = 125°C	
			—	3.70	—		I _C = 25A, V _{GE} = 15V, T _J = 125°C	
	V _{GE(th)}	Gate Threshold Voltage	4.0	5.0	6.0		V _{CE} = V _{GE} , I _C = 250μA	22,23,24
	ΔV _{GE(th)}	Threshold Voltage temp. coefficient	—	-10	—	mV/°C	V _{CE} = V _{GE} , I _C = 1mA (25°C-125°C)	
	I _{CES}	Zero Gate Voltage Collector Current	—	8.0	50	μA	V _{GE} = 0V, V _{CE} = 1200V	
			—	370	—		V _{GE} = 0V, V _{CE} = 1200V, T _J = 125°C	
	I _{GES}	Gate-to-Emitter Leakage Current	—	—	±200	nA	V _{GE} = ±20V	
	Q _g	Total Gate Charge (turn-on)	—	96	145	nC	I _C = 12.5A	26
	Q _{ge}	Gate-to-Emitter Charge (turn-on)	—	46	70		V _{CC} = 400V	CT1
	Q _{gc}	Gate-to-Collector Charge (turn-on)	—	10	15		V _{GE} = 15V	
	E _{on}	Turn-On Switching Loss	—	1050	1200	μJ	I _C = 12.5A, V _{CC} = 600V	CT4
	E _{off}	Turn-Off Switching Loss	—	750	1000		V _{GE} = 15V, R _G = 22Ω, L = 400μH	
	E _{tot}	Total Switching Loss	—	1800	2200		T _J = 25°C ③	
	E _{on}	Turn-On Switching Loss	—	1350	1500	μJ	I _C = 12.5A, V _{CC} = 600V	28,30
	E _{off}	Turn-Off Switching Loss	—	1100	1250		V _{GE} = 15V, R _G = 22Ω, L = 400μH	CT4
	E _{tot}	Total Switching Loss	—	2450	2750		T _J = 125°C ③	WF3,4
t _{d(on)}	Turn-On delay time	—	50	65	ns	I _C = 12.5A, V _{CC} = 600V	29,31	
t _r	Rise time	—	36	50		V _{GE} = 15V, R _G = 22Ω, L = 400μH	CT4	
t _{d(off)}	Turn-Off delay time	—	350	400		T _J = 125°C	WF3	
t _f	Fall time	—	210	275			WF4	
C _{ies}	Input Capacitance	—	2370	—		pF	V _{GE} = 0V	25
C _{oes}	Output Capacitance	—	460	—	V _{CC} = 30V			
C _{res}	Reverse Transfer Capacitance	—	60	—	f = 1.0Mhz			
RBSOA	Reverse Bias Safe Operating Area	FULL SQUARE				T _J = 150°C, I _C = 50A R _G = 22Ω, V _{GE} = +15V to 0V	CT2	
SCSOA	Short Circuit Safe Operating Area	10	—	—	μs	T _J = 150°C V _{CC} = 900V, V _P = 1200V R _G = 22Ω, V _{GE} = +15V to 0V	CT3	
Brake Diode	I _{rr}	Diode Peak Reverse Recovery Current	—	24	—	A	V _{CC} = 600V, I _F = 12.5A, L = 400μH V _{GE} = 15V, R _G = 22Ω, T _J = 125°C	32,33,34 CT4
	V _{FM}	Diode Forward Voltage Drop	—	1.90	2.10	V	I _F = 8.0A	27
			—	2.40	2.65		I _F = 16A	
			—	2.00	—		I _F = 8.0A, T _J = 125°C	
—			2.65	—	I _F = 16A, T _J = 125°C			
NTC	R	Resistance	4538	5000	5495	Ω	T _J = 25°C	16
			468.6	493.3	518.0		T _J = 100°C	
	B	B Value	3307	3375	3443	K	T _J = 25 / 50 °C	

Note:

- ① For UL Applications, T_J is limited to +125°C. (See File E78996).
- ② Power dependent on temperature. T_J not to exceed T_J max.
- ③ Energy losses include "tail" and diode reverse recovery.

Inverter

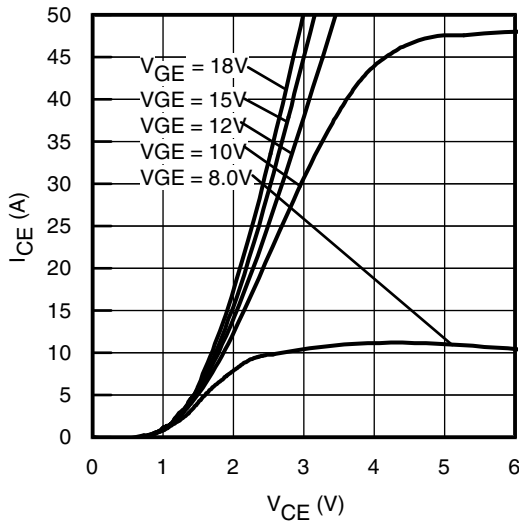

Fig. 1 - Typ. IGBT Output Characteristics
 $T_J = 25^\circ\text{C}$; $t_p = 80\mu\text{s}$

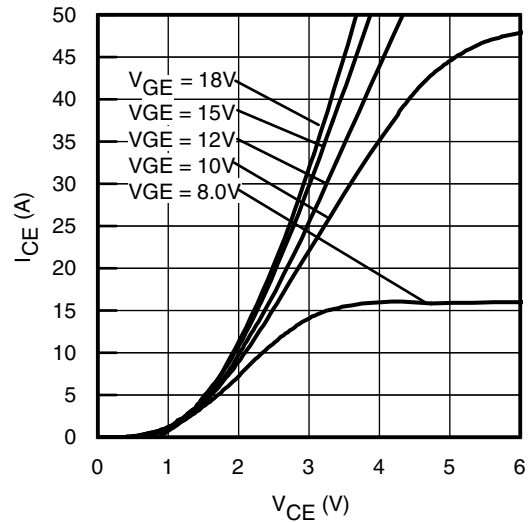

Fig. 2 - Typ. IGBT Output Characteristics
 $T_J = 125^\circ\text{C}$; $t_p = 80\mu\text{s}$

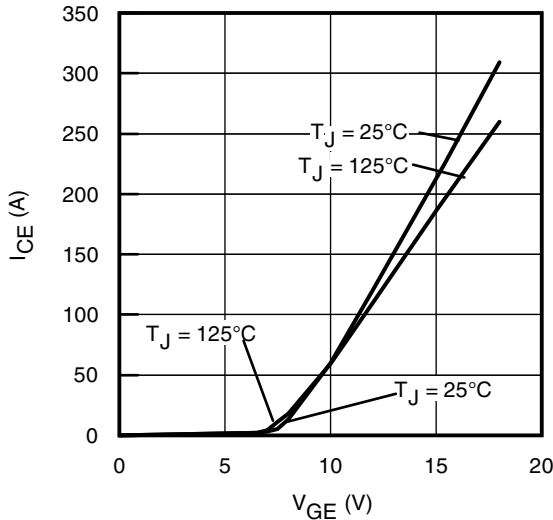

Fig. 3 - Typ. Transfer Characteristics
 $V_{CE} = 50\text{V}$; $t_p = 10\mu\text{s}$

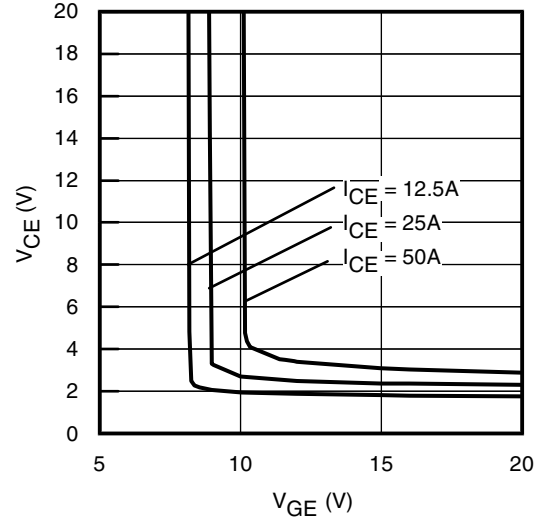

Fig. 4 - Typical V_{CE} vs. V_{GE}
 $T_J = 25^\circ\text{C}$

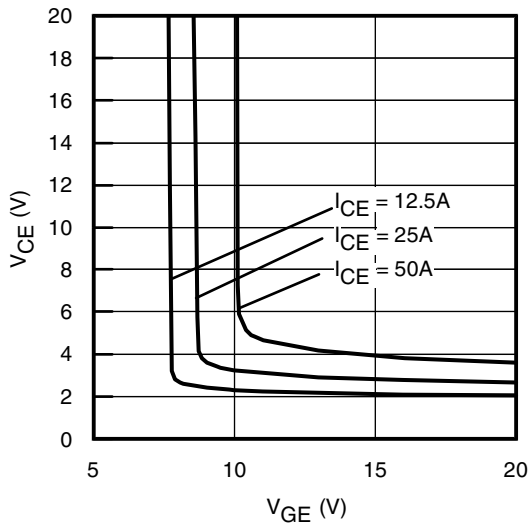

Fig. 5 - Typical V_{CE} vs. V_{GE}
 $T_J = 125^\circ\text{C}$

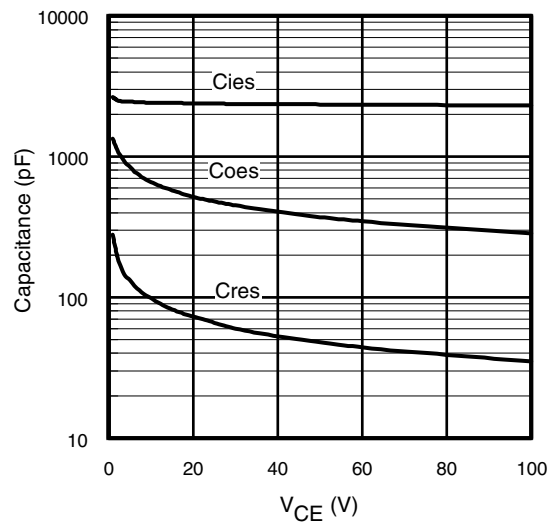

Fig. 6 - Typ. Capacitance vs. V_{CE}
 $V_{GE} = 0\text{V}$; $f = 1\text{MHz}$

Inverter

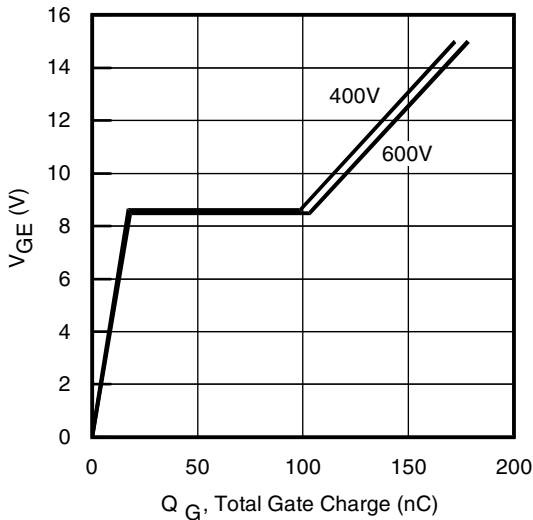

Fig. 7 - Typical Gate Charge vs. V_{GE}
 $I_{CE} = 25A$; $L = 1mH$

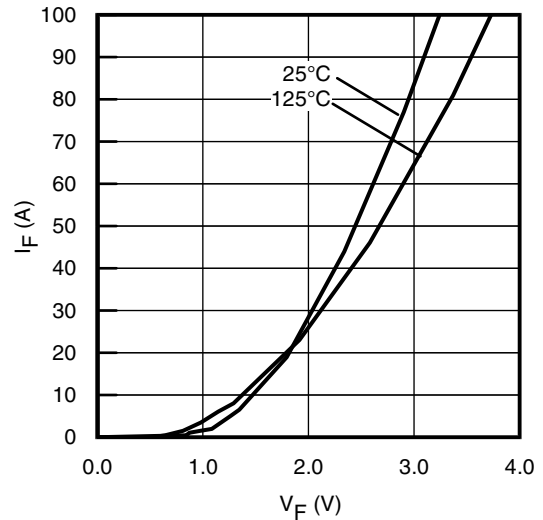

Fig. 8 - Typ. Diode Forward Characteristics
 $t_p = 80\mu s$

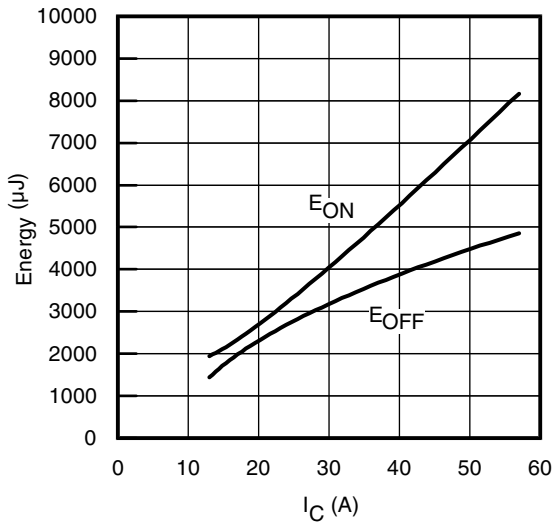

Fig. 9 - Typ. Energy Loss vs. I_C
 $T_J = 125^\circ C$; $L = 400\mu H$; $V_{CE} = 600V$, $R_G = 10\Omega$; $V_{GE} = 15V$

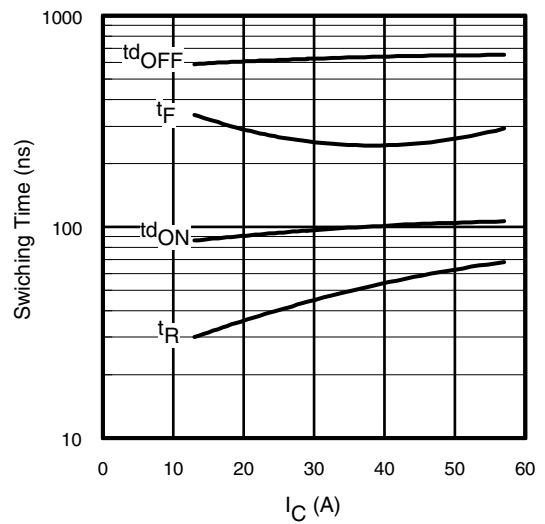

Fig. 10 - Typ. Switching Time vs. I_C
 $T_J = 125^\circ C$; $L = 400\mu H$; $V_{CE} = 600V$, $R_G = 10\Omega$; $V_{GE} = 15V$

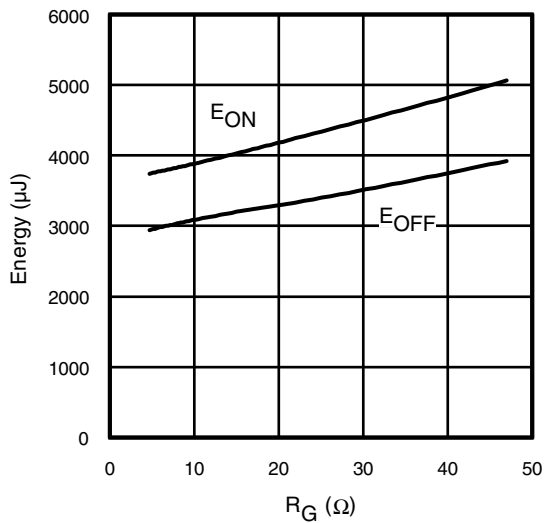

Fig. 11 - Typ. Energy Loss vs. R_G
 $T_J = 125^\circ C$; $L = 400\mu H$; $V_{CE} = 600V$, $I_{CE} = 25A$; $V_{GE} = 15V$

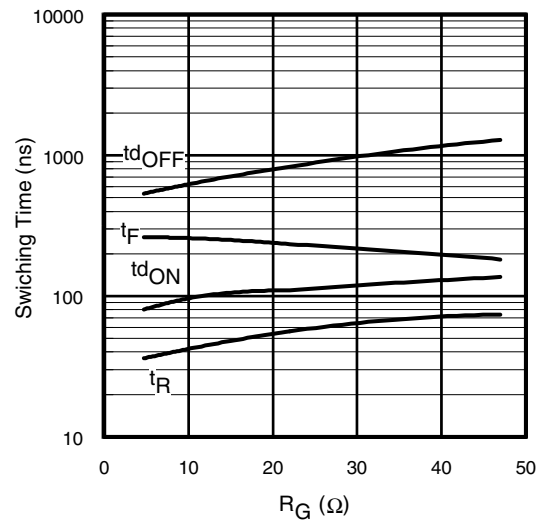

Fig. 12 - Typ. Switching Time vs. R_G
 $T_J = 125^\circ C$; $L = 400\mu H$; $V_{CE} = 600V$, $I_{CE} = 25A$; $V_{GE} = 15V$

Inverter

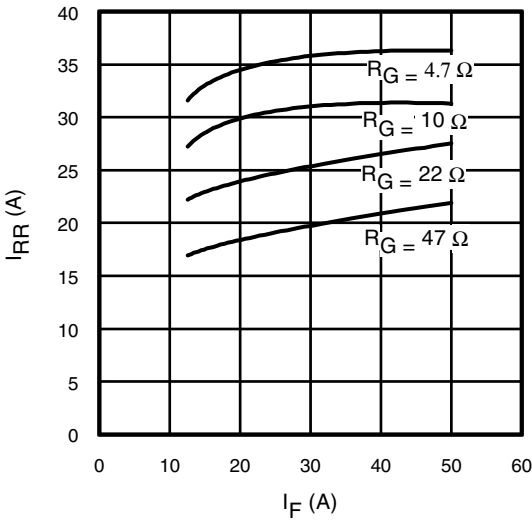

Fig. 13 - Typical Diode I_{RR} vs. I_F
 $T_J = 125^\circ\text{C}$

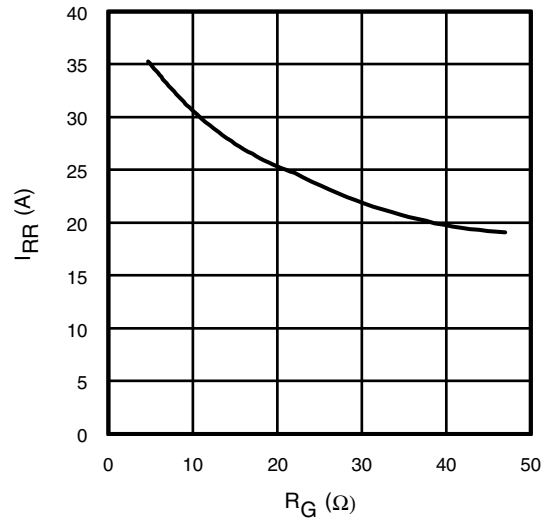

Fig. 14 - Typical Diode I_{RR} vs. R_G
 $T_J = 125^\circ\text{C}; I_F = 25\text{A}$

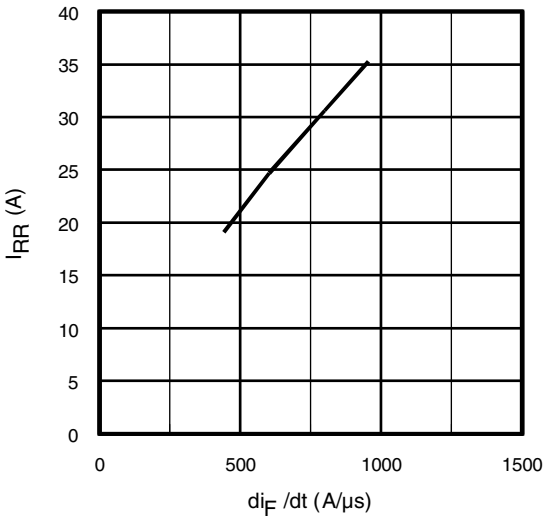

Fig. 15 - Typical Diode I_{RR} vs. di_F/dt
 $V_{CC} = 600\text{V}; V_{GE} = 15\text{V}; I_F = 25\text{A}; T_J = 125^\circ\text{C}$

Thermistor

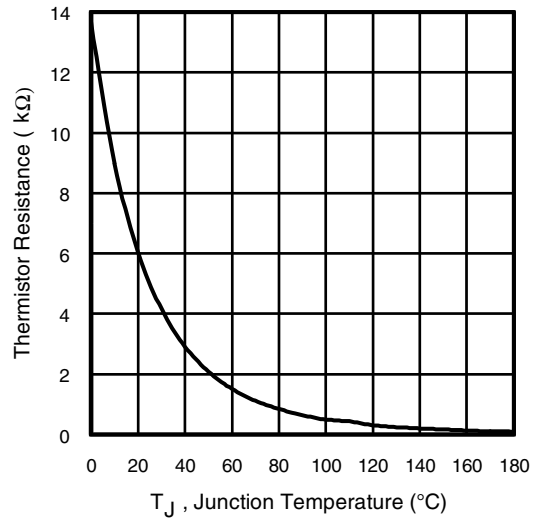

Fig. 16 - Thermistor Resistance vs. Temperature

Input Rectifier

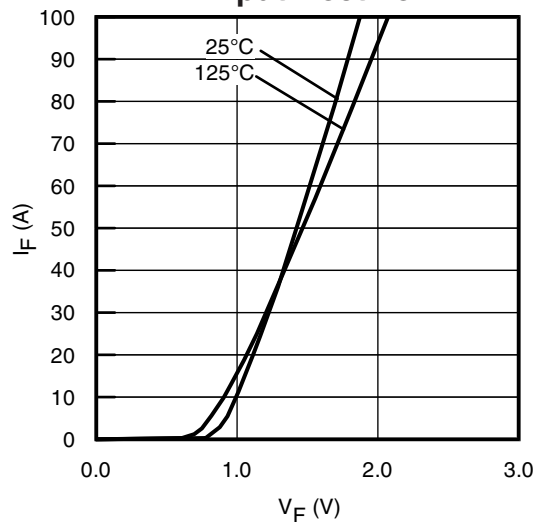

Fig. 17 - Typ. Diode Forward Characteristics
 $t_p = 80\mu\text{s}$

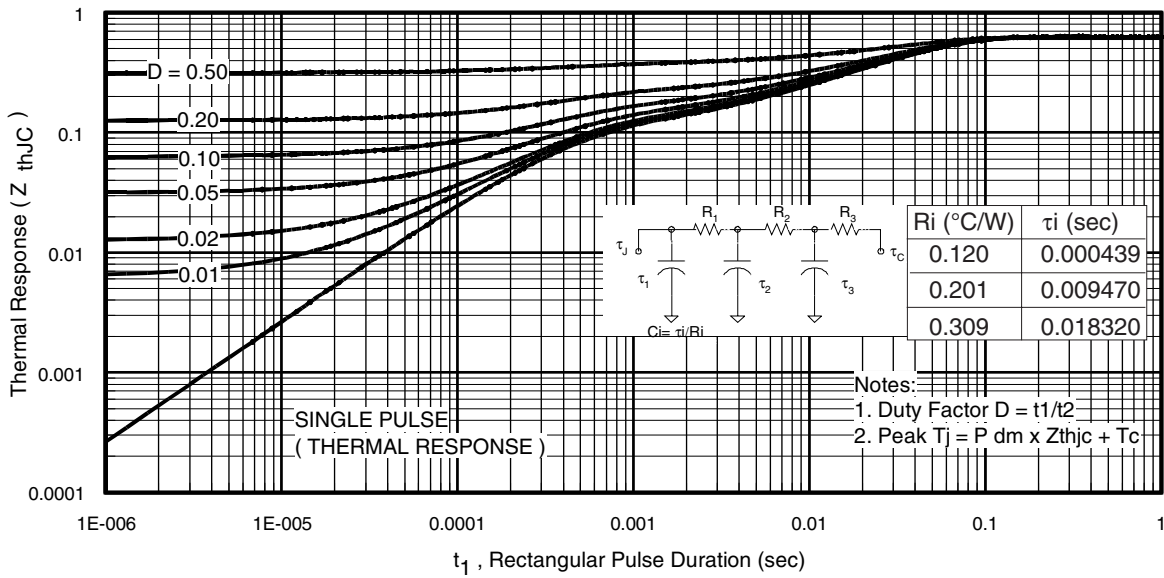

Fig 18. Maximum Transient Thermal Impedance, Junction-to-Case (Inverter IGBT)

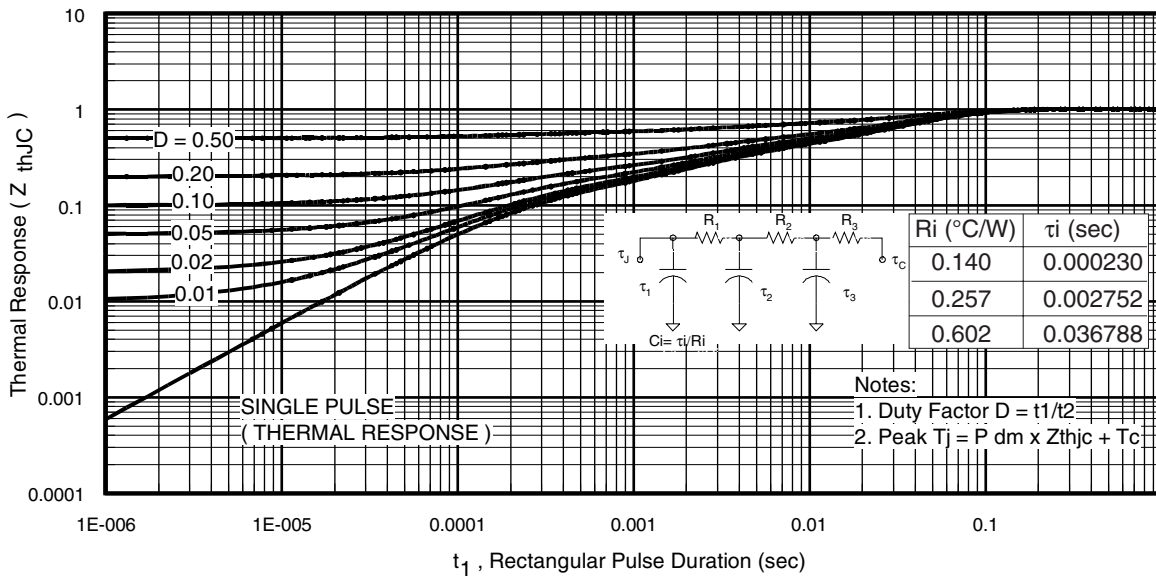

Fig 19. Maximum Transient Thermal Impedance, Junction-to-Case (Inverter FRED)

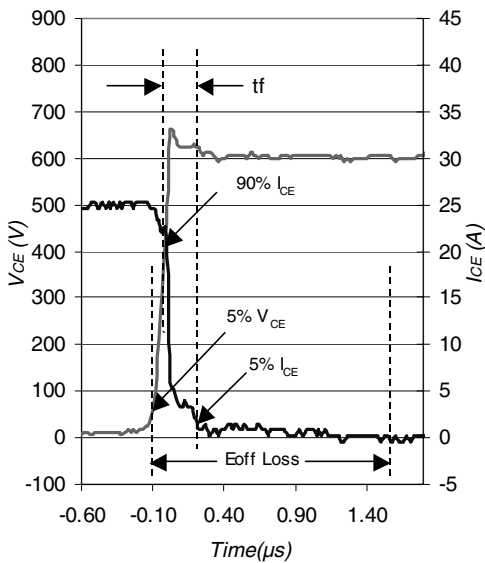

Fig. WF1- Typ. Turn-off Loss Waveform
@ $T_j = 125^\circ\text{C}$ using Fig. CT.4

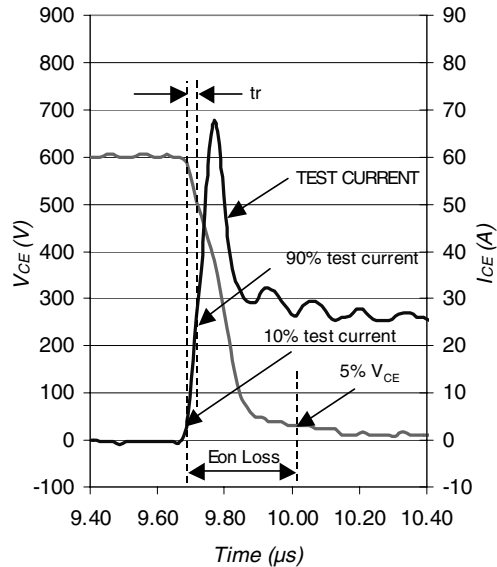

Fig. WF2- Typ. Turn-on Loss Waveform
@ $T_j = 125^\circ\text{C}$ using Fig. CT.4

Brake

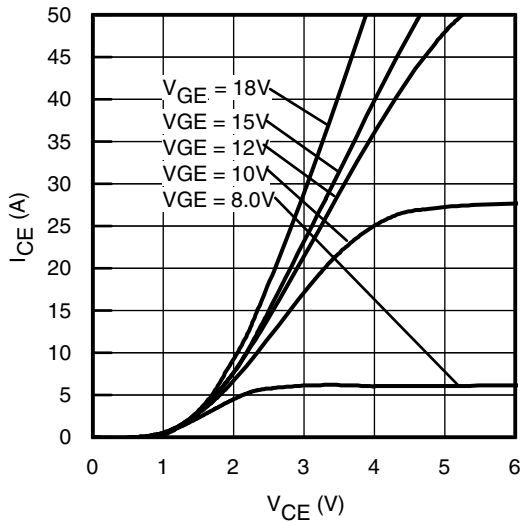

Fig. 20 - Typ. IGBT Output Characteristics
 $T_J = 25^\circ\text{C}$; $t_p = 80\mu\text{s}$

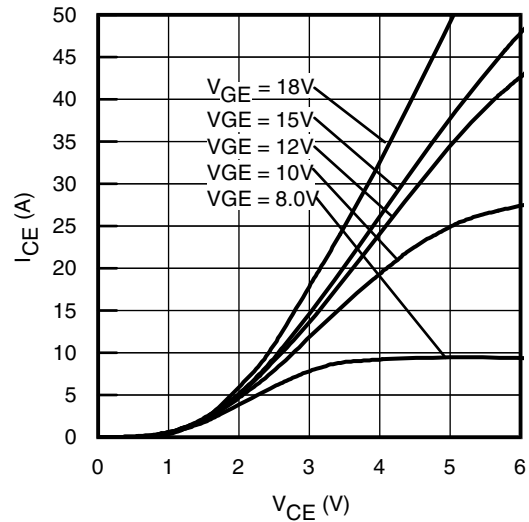

Fig. 21 - Typ. IGBT Output Characteristics
 $T_J = 125^\circ\text{C}$; $t_p = 80\mu\text{s}$

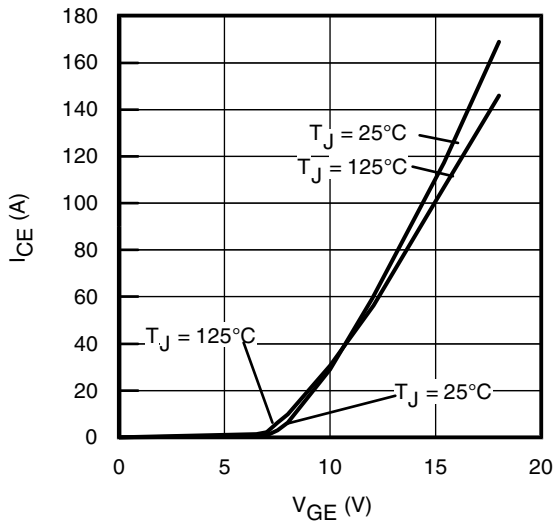

Fig. 22 - Typ. Transfer Characteristics
 $V_{CE} = 50\text{V}$; $t_p = 10\mu\text{s}$

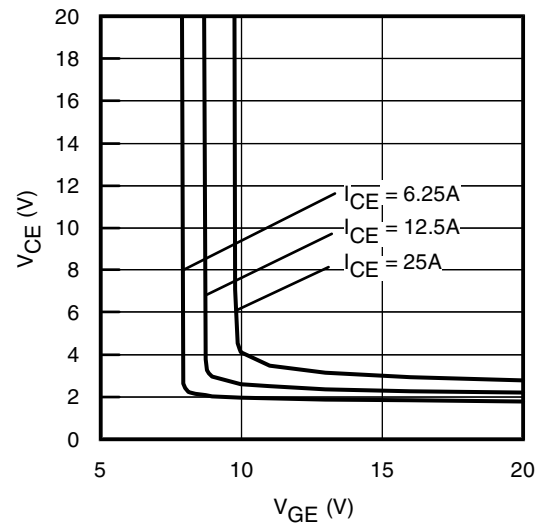

Fig. 23 - Typical V_{CE} vs. V_{GE}
 $T_J = 25^\circ\text{C}$

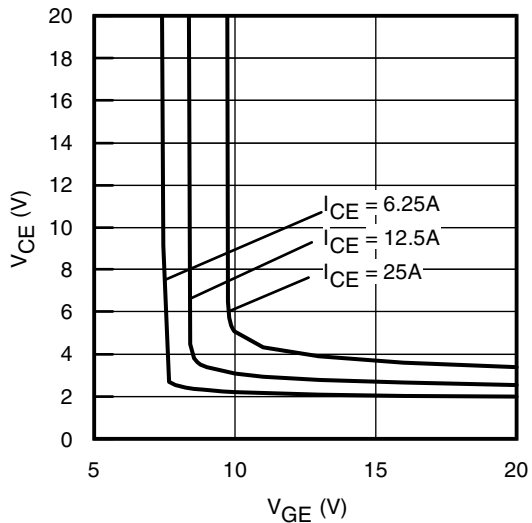

Fig. 24 - Typical V_{CE} vs. V_{GE}
 $T_J = 125^\circ\text{C}$

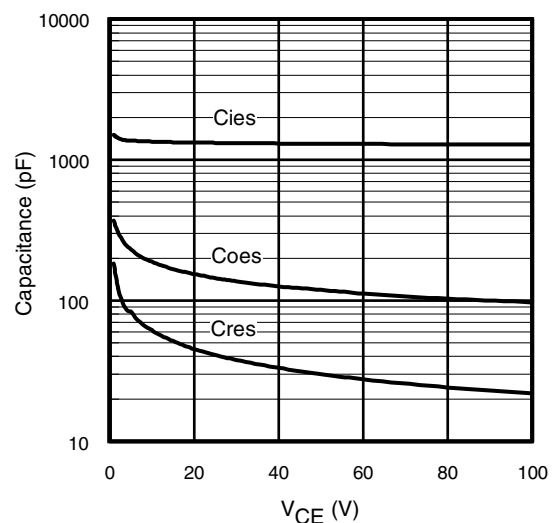

Fig. 25 - Typ. Capacitance vs. V_{CE}
 $V_{GE} = 0\text{V}$; $f = 1\text{MHz}$

Brake

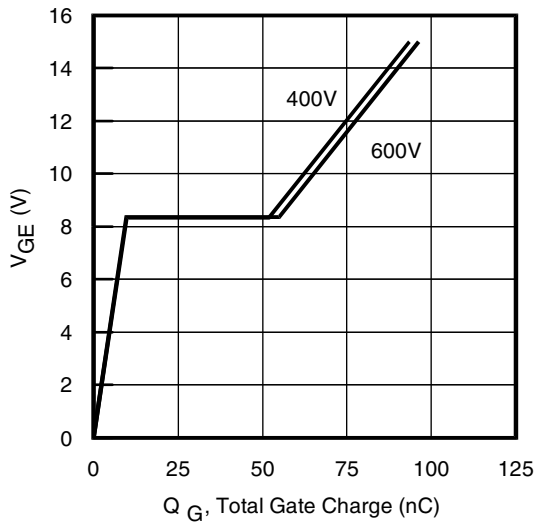

Fig. 26 - Typical Gate Charge vs. V_{GE}
 $I_{CE} = 12.5A$; $L = 1mH$

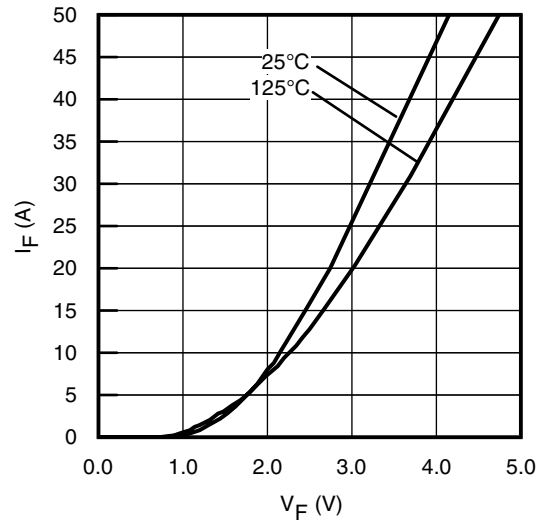

Fig. 27 - Typ. Diode Forward Characteristics
 $t_p = 80\mu s$

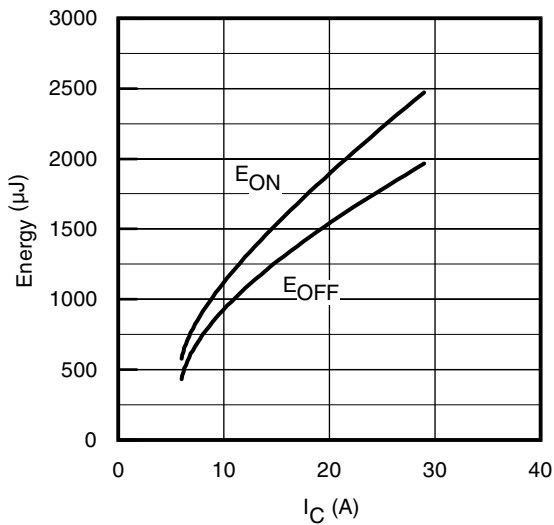

Fig. 28 - Typ. Energy Loss vs. I_C
 $T_J = 125^\circ C$; $L = 400\mu H$; $V_{CE} = 600V$, $R_G = 22\Omega$; $V_{GE} = 15V$

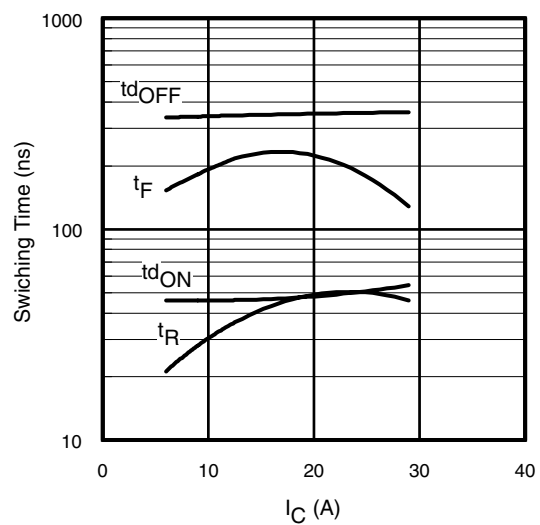

Fig. 29 - Typ. Switching Time vs. I_C
 $T_J = 125^\circ C$; $L = 400\mu H$; $V_{CE} = 600V$, $R_G = 22\Omega$; $V_{GE} = 15V$

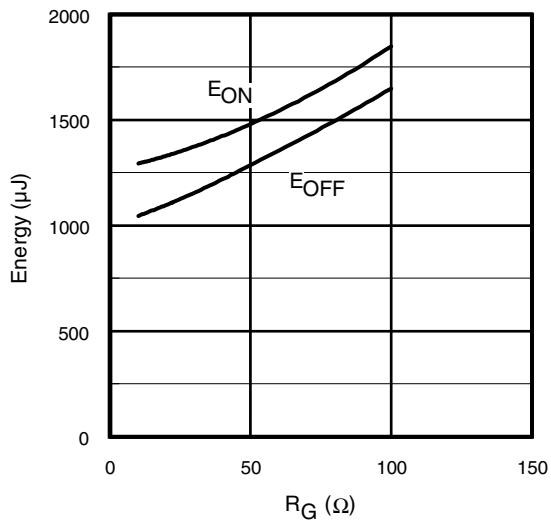

Fig. 30 - Typ. Energy Loss vs. R_G
 $T_J = 125^\circ C$; $L = 400\mu H$; $V_{CE} = 600V$, $I_{CE} = 12.5A$; $V_{GE} = 15V$

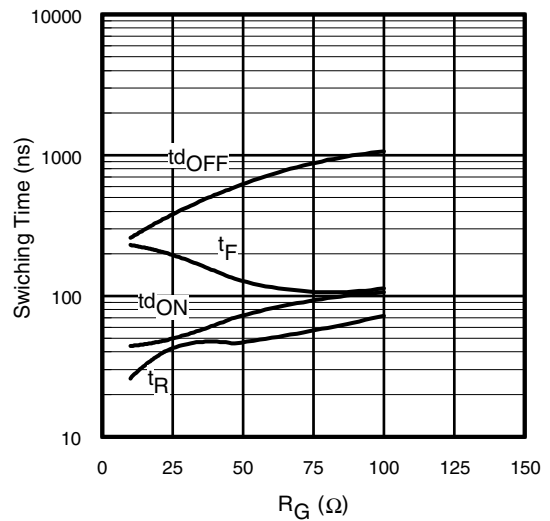

Fig. 31 - Typ. Switching Time vs. R_G
 $T_J = 125^\circ C$; $L = 400\mu H$; $V_{CE} = 600V$, $I_{CE} = 12.5A$; $V_{GE} = 15V$

Brake

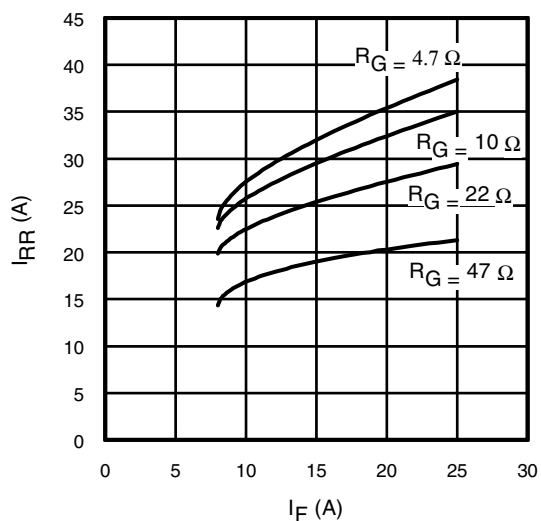

Fig. 32 - Typical Diode I_{RR} vs. I_F
 $T_J = 125^\circ\text{C}$

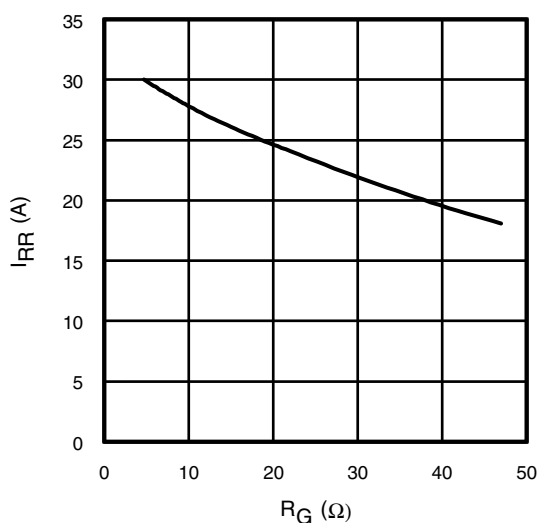

Fig. 33- Typical Diode I_{RR} vs. R_G
 $T_J = 125^\circ\text{C}$; $I_F = 12.5\text{A}$

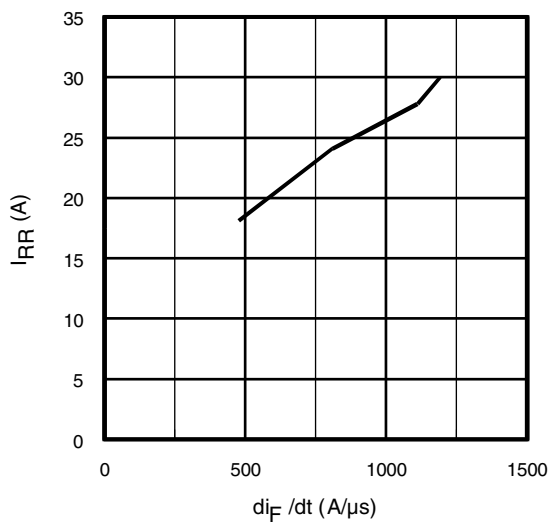

Fig. 34 - Typical Diode I_{RR} vs. di_F/dt
 $V_{CC} = 600\text{V}$; $V_{GE} = 15\text{V}$; $I_F = 12.5\text{A}$; $T_J = 125^\circ\text{C}$

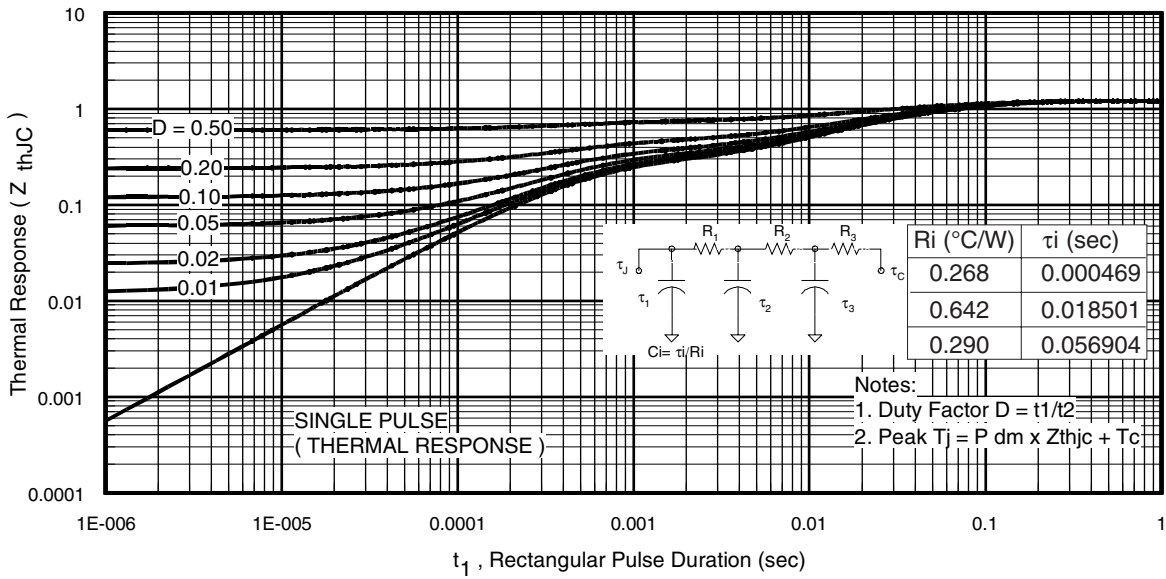

Fig 35. Maximum Transient Thermal Impedance, Junction-to-Case (Brake IGBT)

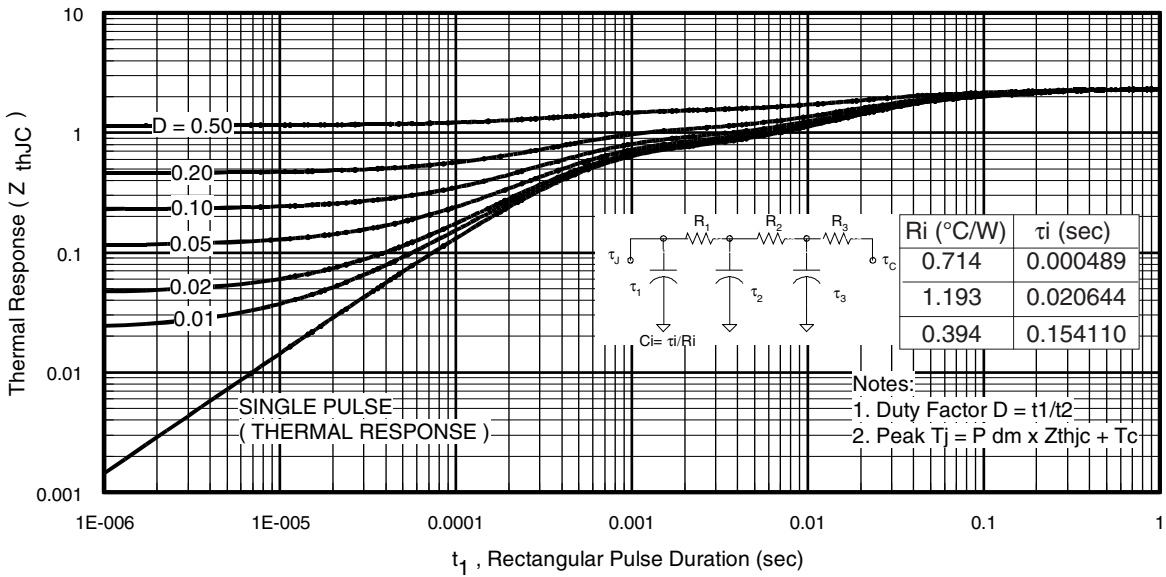

Fig 36. Maximum Transient Thermal Impedance, Junction-to-Case (Brake Diode)

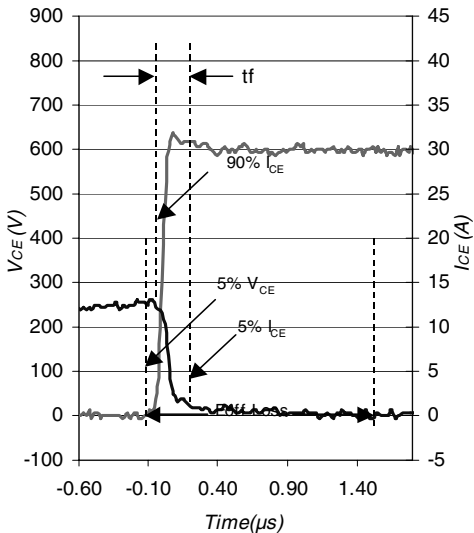

Fig. WF3- Typ. Turn-off Loss Waveform @ $T_j = 125^\circ\text{C}$ using Fig. CT.4

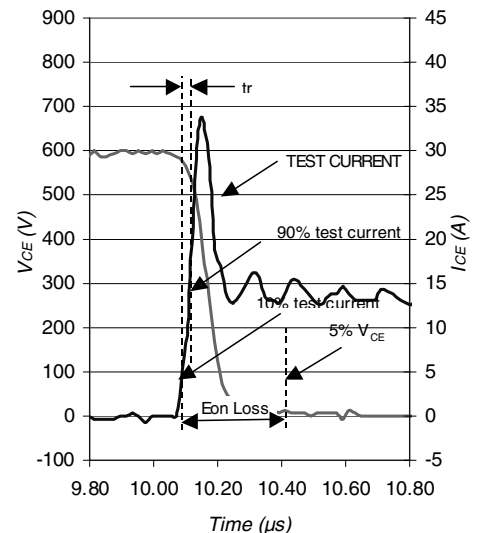

Fig. WF4- Typ. Turn-on Loss Waveform @ $T_j = 125^\circ\text{C}$ using Fig. CT.4

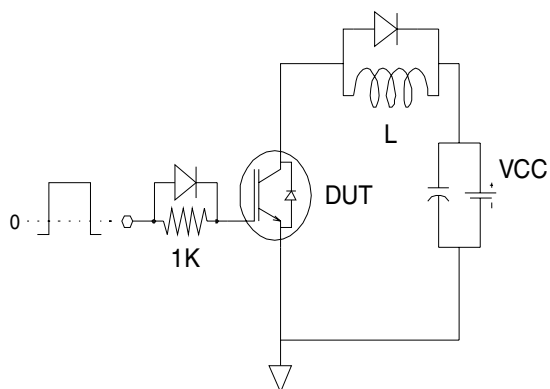

Fig.C.T.1 - Gate Charge Circuit (turn-off)

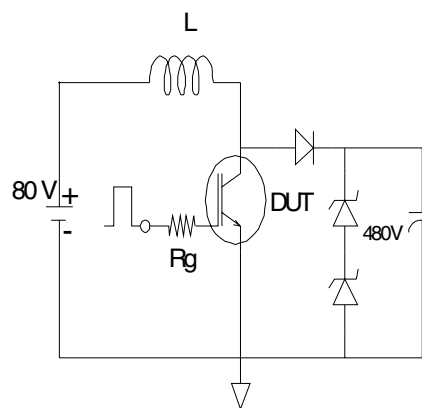

Fig.C.T.2 - RBSOA Circuit

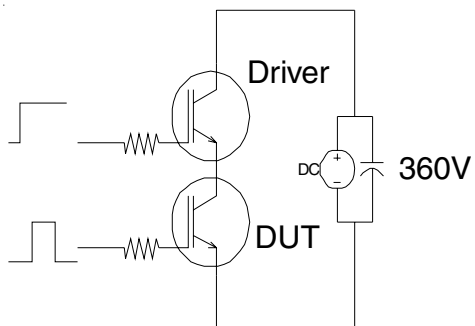

Fig.C.T.3 - S.C.SOA Circuit

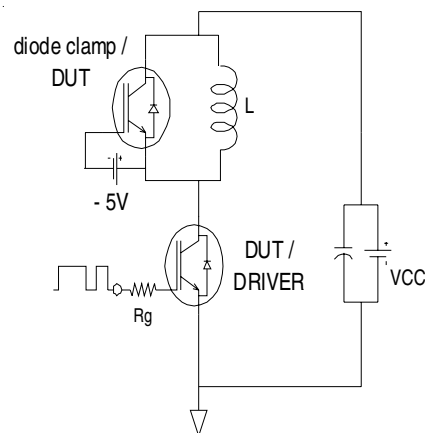

Fig.C.T.4 - Switching Loss Circuit

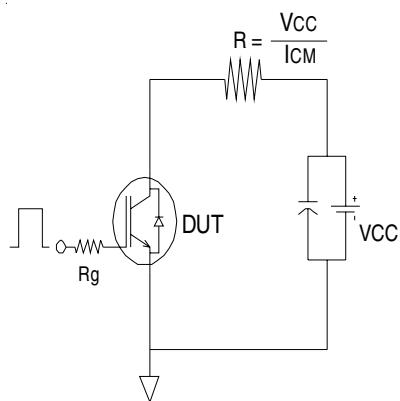
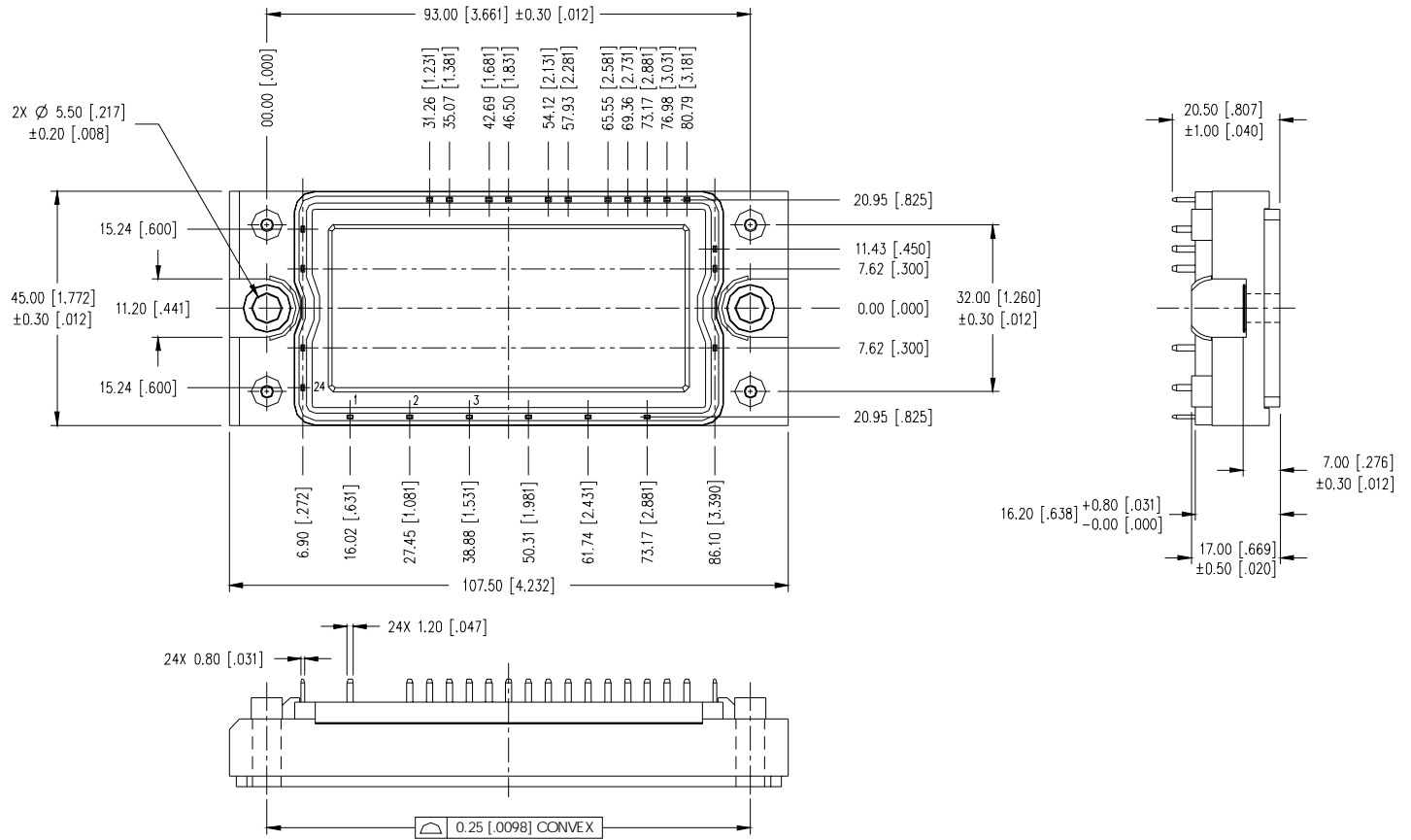

Fig.C.T.5 - Resistive Load Circuit

Econo2 PIM Package Outline

Dimensions are shown in millimeters (inches)



Econo2 PIM Part Marking Information

EXAMPLE: THIS IS A GB25RF120K
 LOT CODE: 401438
 ASSEMBLED ON WW 21, 2002

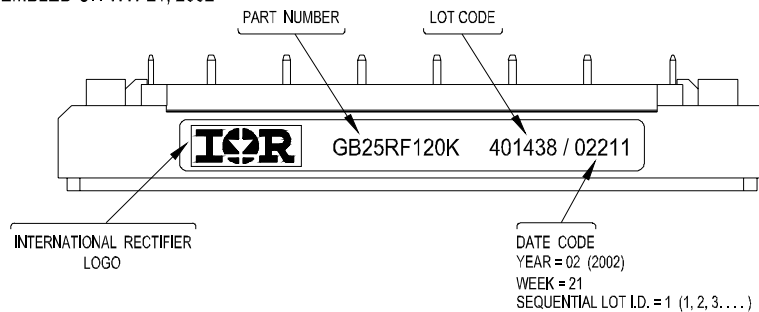

Data and specifications subject to change without notice.
 This product has been designed and qualified for Industrial market.
 Qualification Standards can be found on IR's Web site.