

GL5□□44 series

ø5mm(T-1 3/4), Cylinder Type, Colorless Transparency, High-luminosity LED Lamps for Outdoor Use

Outline Dimensions

(Unit : mm)

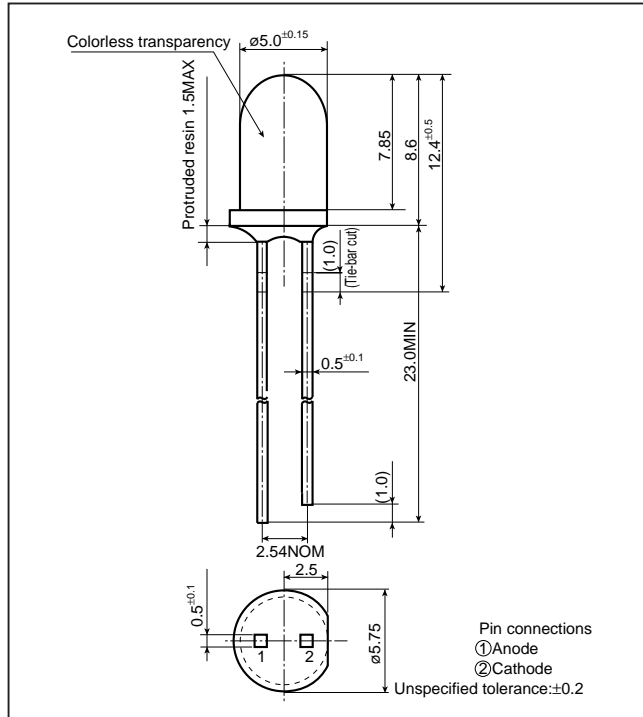

Radiation Diagram

(Ta=25°C)

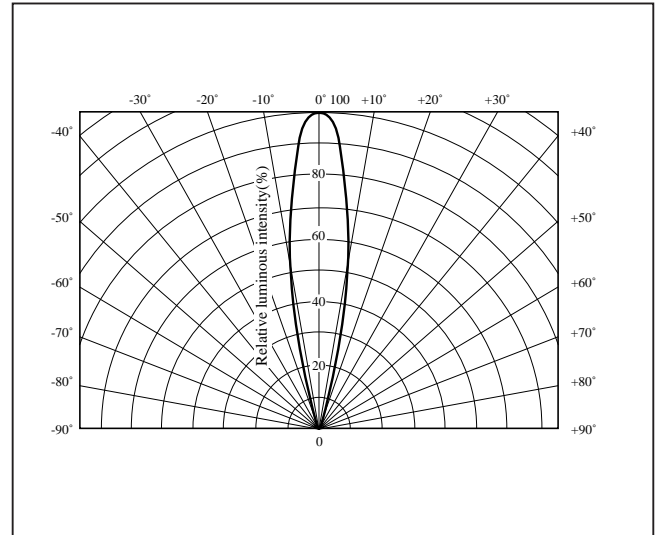

Absolute Maximum Ratings

(Ta=25°C)

Model No.	Radiation color	Radiation material	Power dissipation P (mW)	Forward current I _F (mA)	Peak forward current I _{FM} (mA)	Derating factor (mA/°C)		Reverse voltage V _R (V)	Operating temperature T _{opr} (°C)	Storage temperature T _{stg} (°C)	Soldering temperature T _{sol} ^{*3} (°C)
						DC	Pulse				
GL5UR44	Red(Super-luminosity)	GaAlAs on GaAlAs	75	30	50 ^{*1}	0.40	0.67	4	-25 to +85	-25 to +100	260
GL5TR44	Red(High-luminosity)	GaAlAs on GaAs	110	50	300 ^{*2}	0.67	4.00	5	-25 to +85	-25 to +100	260
GL5HJ44	Orange(Super-luminosity)	AlGaInP	130	50	100 ^{*1}	0.67	1.33	4.1	-25 to +85	-25 to +100	260
GL5HV44	Yellow(Super-luminosity)	AlGaInP	130	50	100 ^{*1}	0.67	1.33	4.1	-25 to +85	-25 to +100	260

*1 Duty ratio=1/10, Pulse width=0.1ms

*2 Duty ratio=1/16, Pulse width≤1ms

*3 5s or less(At the position of 1.6mm or more from the bottom face of resin package)

Electro-optical Characteristics

(Ta=25°C)

Lens type	Model No.	Forward voltage V _F (V)		Peak emission wavelength λ _p (nm)		Luminous intensity I _v (mcd)		Spectrum radiation bandwidth Δλ(nm)		Reverse current I _R (μA)		Terminal capacitance C _t (pF)		Page for characteristics diagrams
		TYP	MAX	TYP	I _F (mA)	TYP	I _F (mA)	TYP	I _F (mA)	MAX	V _R (V)	TYP	(MHz)	
Colorless transparency	GL5UR44	1.85	2.5	660	20	850	20	20	20	100	3	25	1	→
	GL5TR44	1.75	2.2	660	20	100	20	20	20	10	4	30	1	→
	GL5HJ44	1.9	2.6	620	20	1 400	20	18	20	100	4	26	1	→
	GL5HV44	1.9	2.6	590	20	700	20	13	20	100	4	24	1	→

(Notice) • In the absence of confirmation by device specification sheets, SHARP takes no responsibility for any defects that may occur in equipment using any SHARP devices shown in catalogs, data books, etc. Contact SHARP in order to obtain the latest device specification sheets before using any SHARP device.

(Internet) • Data for sharp's optoelectronic/power device is provided for internet.(Address <http://www.sharp.co.jp/ecg/>)

LED Lamp Characteristics Diagrams

UR series

Forward Current Derating Curve

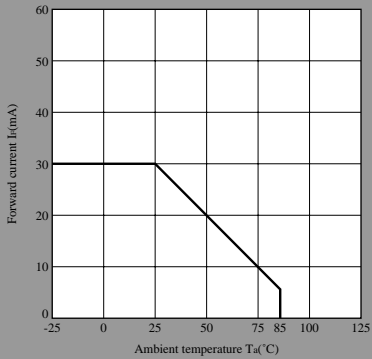

Forward Current vs. Forward Voltage(Note)

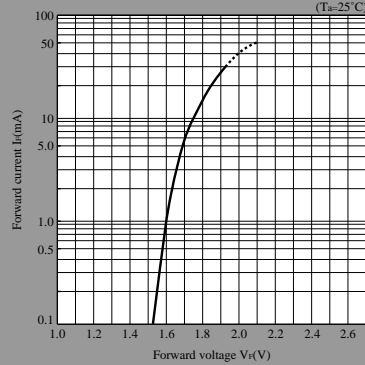

Luminous Intensity vs. Ambient Temperature(Note)

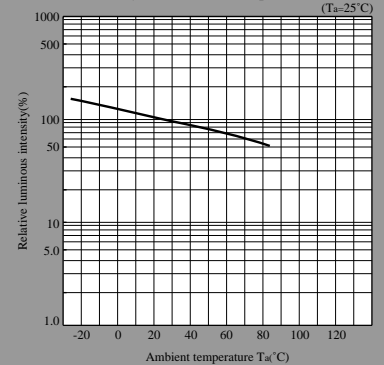

Peak Forward Current Derating Curve

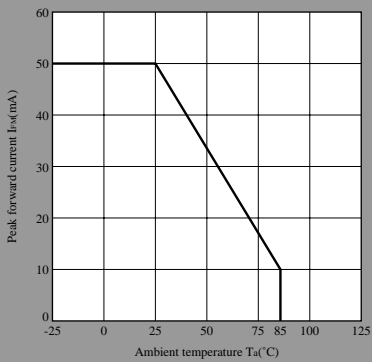

Luminous Intensity vs. Forward Current(Note)

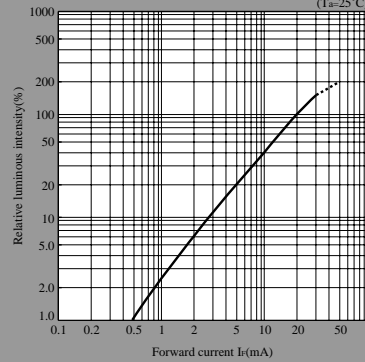

Duty Ratio vs. Peak Forward Current

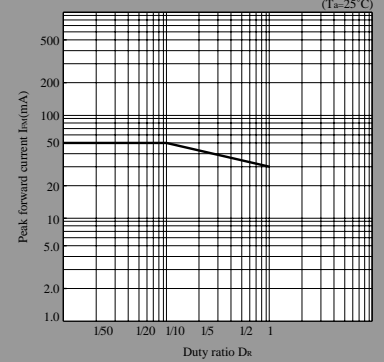

TR series

Forward Current Derating Curve

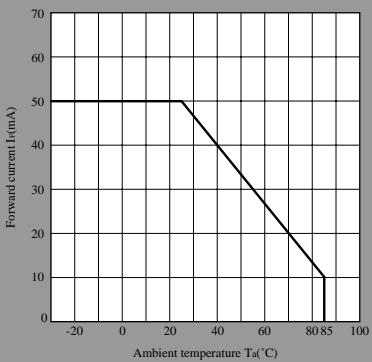

Forward Current vs. Forward Voltage(Note)

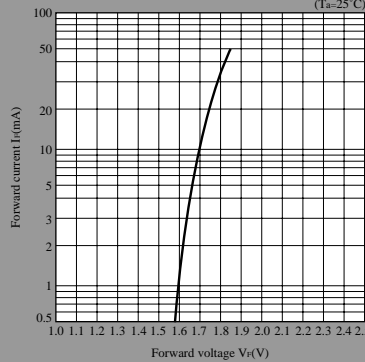

Luminous Intensity vs. Ambient Temperature(Note)

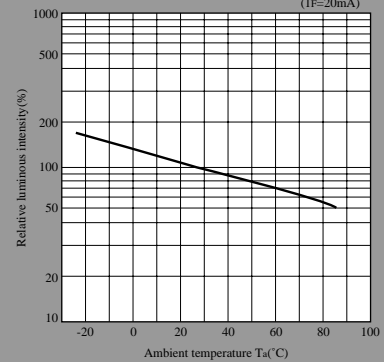

Peak Forward Current Derating Curve

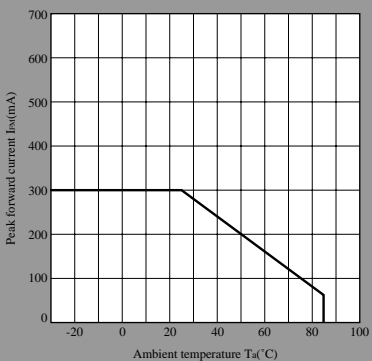

Luminous Intensity vs. Forward Current(Note)

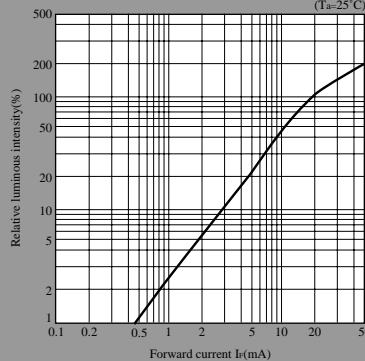

Duty Ratio vs. Peak Forward Current

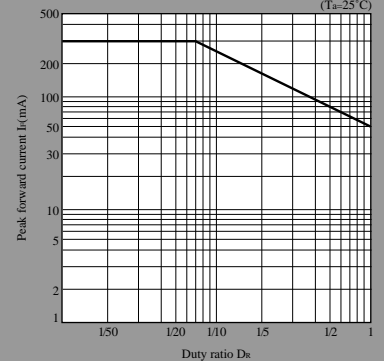

Note) Characteristics shown in diagrams are typical values. (not assurance value)

- (Notice) • In the absence of confirmation by device specification sheets, SHARP takes no responsibility for any defects that may occur in equipment using any SHARP devices shown in catalogs, data books, etc. Contact SHARP in order to obtain the latest device specification sheets before using any SHARP device.
 (Internet) • Data for sharp's optoelectronic/power device is provided for internet.(Address <http://www.sharp.co.jp/ecg/>)

LED Lamp Characteristics Diagrams

HV series

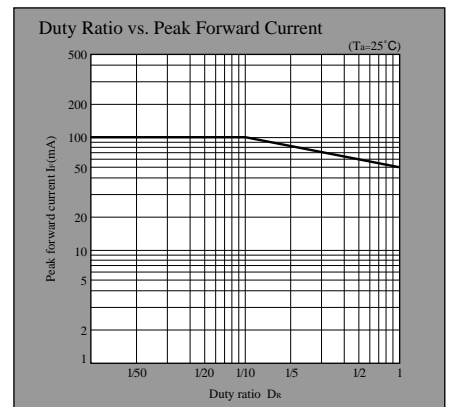
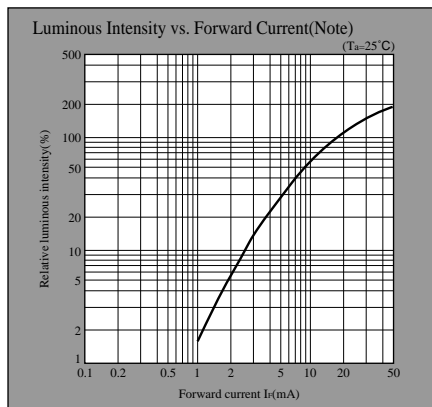
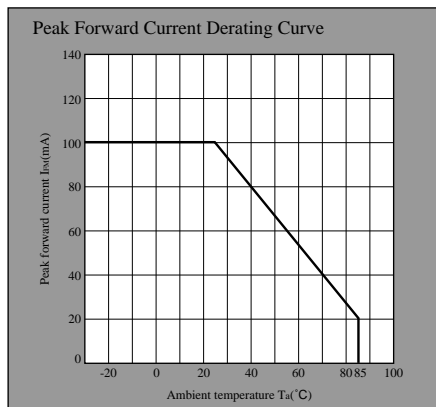
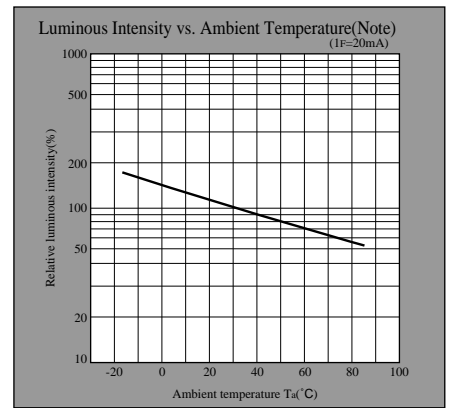
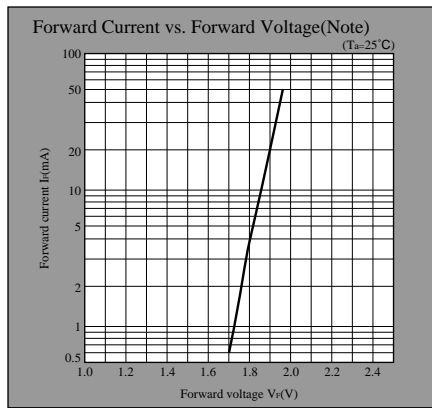
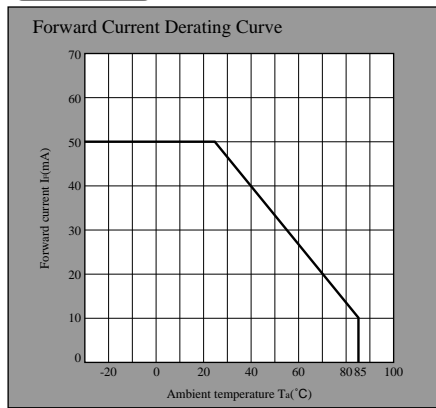

HJ series

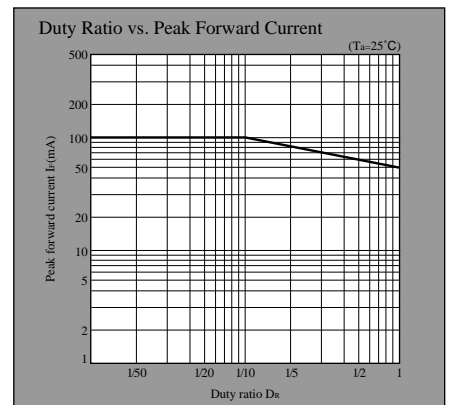
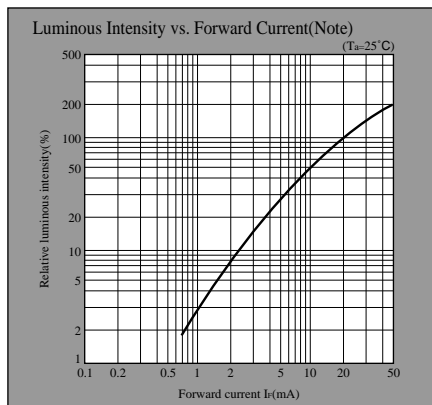
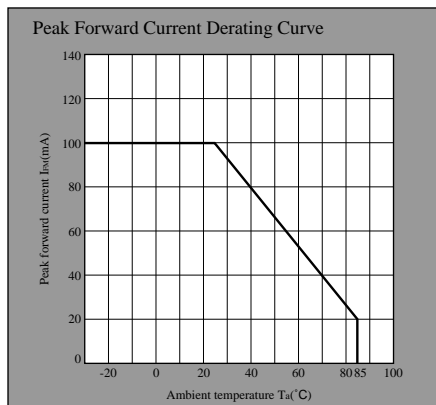
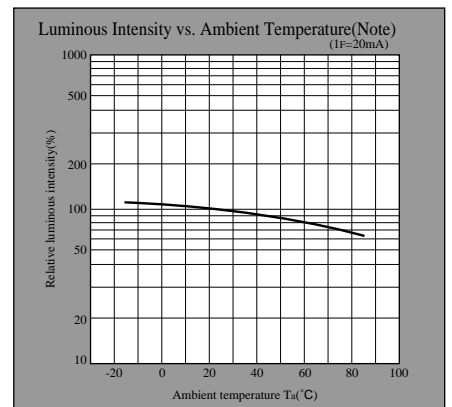
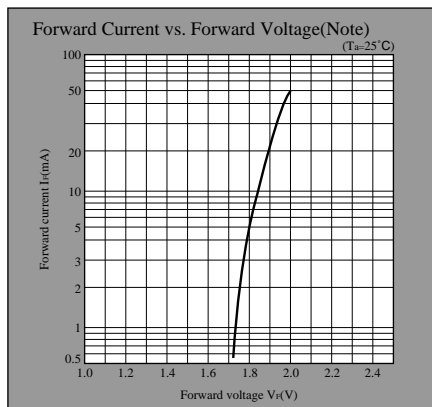
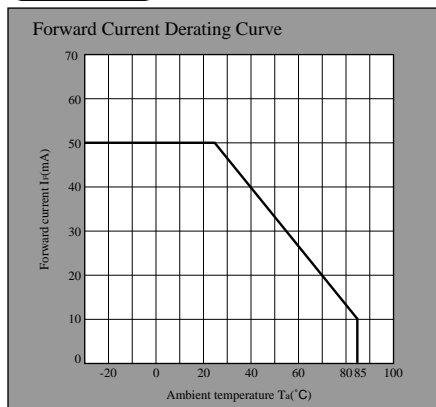

Note) Characteristics shown in diagrams are typical values. (not assurance value)

- (Notice) • In the absence of confirmation by device specification sheets, SHARP takes no responsibility for any defects that may occur in equipment using any SHARP devices shown in catalogs, data books, etc. Contact SHARP in order to obtain the latest device specification sheets before using any SHARP device.
- (Internet) • Data for sharp's optoelectronic/power device is provided for internet. (Address <http://www.sharp.co.jp/ecg/>)