

GP1S06

High Sensing Accuracy Type Photointerrupter

■ Features

1. High sensing accuracy
(Slit width : 0.25mm)
2. PWB direct mounting type package

■ Applications

1. Floppy disk drives
2. Copiers, printers, facsimiles
3. Optoelectronic switches, optoelectronic counters

■ Outline Dimensions

(Unit : mm)

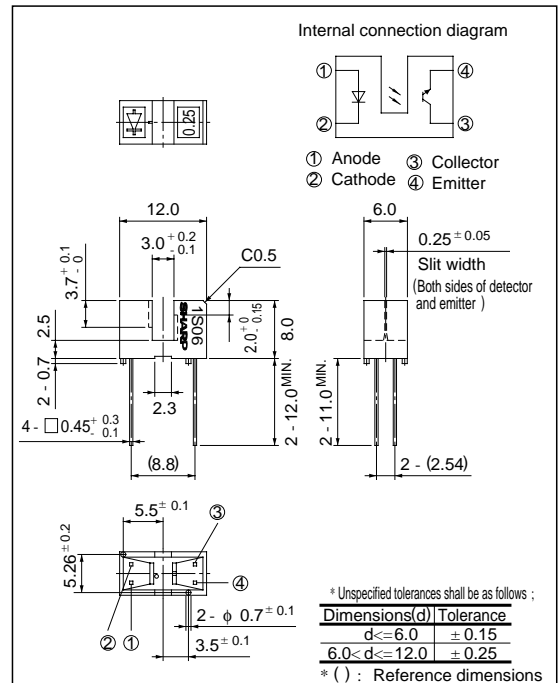

■ Absolute Maximum Ratings

(Ta = 25°C)

Parameter		Symbol	Rating	Unit
Input	Forward current	I_F	50	mA
	*1 Peak forward current	I_{FM}	1	A
	Reverse voltage	V_R	6	V
	Power dissipation	P	75	mW
Output	Collector-emitter voltage	V_{CEO}	35	V
	Emitter-collector voltage	V_{ECO}	6	V
	Collector current	I_C	20	mA
	Collector power dissipation	P_C	75	mW
Operating temperature		T_{opr}	- 25 to + 85	°C
Storage temperature		T_{stg}	- 40 to + 100	°C
*2 Soldering temperature		T_{sol}	260	°C

*1 Pulse width $\leq 100 \mu s$, Duty ratio = 0.01

*2 For 5 seconds

■ Electro-optical Characteristics

($T_a = 25^\circ\text{C}$)

Parameter		Symbol	Conditions	MIN.	TYP.	MAX.	Unit	
Input	Forward voltage	V_F	$I_F = 20\text{mA}$	-	1.2	1.4	V	
	Peak forward voltage	V_{FM}	$I_{FM} = 0.5\text{A}$	-	3	4	V	
	Reverse current	I_R	$V_R = 3\text{V}$	-	-	10	μA	
Output	Collector dark current	I_{CEO}	$V_{CE} = 20\text{V}$	-	1	100	nA	
Transfer characteristics	Collector Current		I_c	$V_{CE} = 5\text{V}, I_F = 20\text{mA}$	0.1	-	2.5	mA
	Collector-emitter saturation voltage		$V_{CE(sat)}$	$I_F = 40\text{mA}, I_C = 50\ \mu\text{A}$	-	-	0.4	V
	Response time	Rise time	t_r	$V_{CE} = 2\text{V}, I_C = 0.5\text{mA}, R_L = 1\text{k}\Omega$	-	38	90	μs
		Fall time	t_f		-	48	110	μs

Fig. 1 Forward Current vs. Ambient Temperature

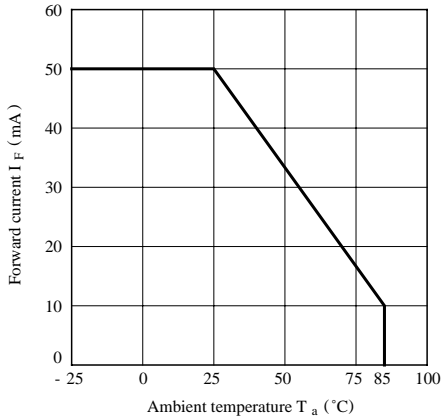

Fig. 2 Collector Power Dissipation vs. Ambient Temperature

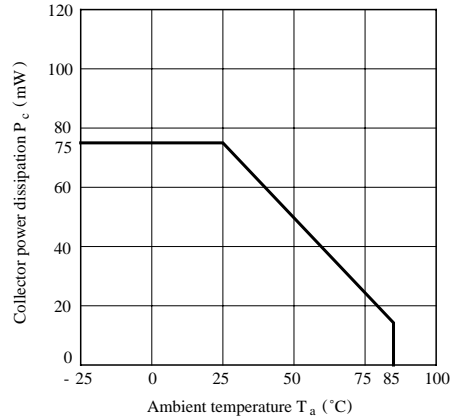

Fig. 3 Peak Forward Current vs. Duty Ratio

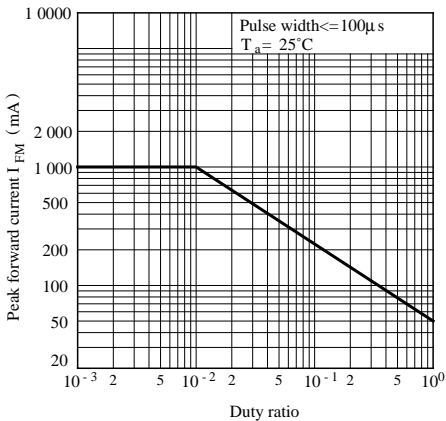

Fig. 4 Forward Current vs. Forward Voltage

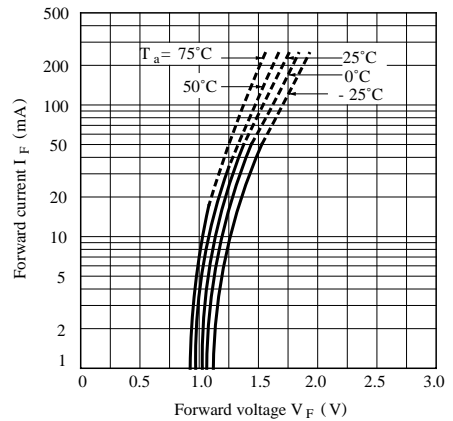

Fig. 5 Collector Current vs. Forward Current

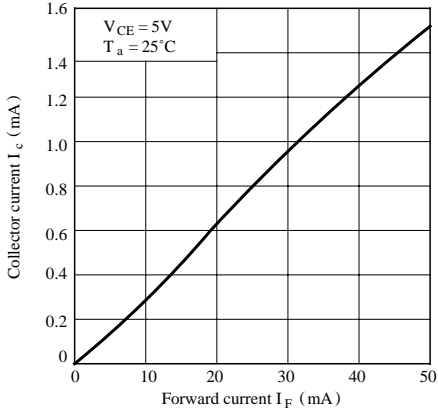

Fig. 6 Collector Current vs. Collector-emitter Voltage

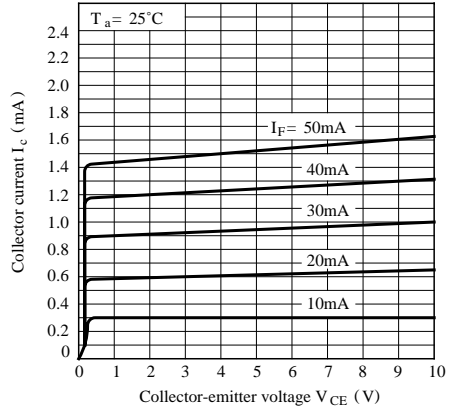

Fig. 7 Collector Current vs. Ambient Temperature

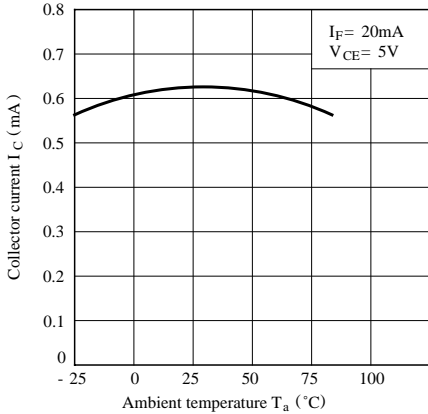

Fig. 8 Collector-emitter Saturation Voltage vs. Ambient Temperature

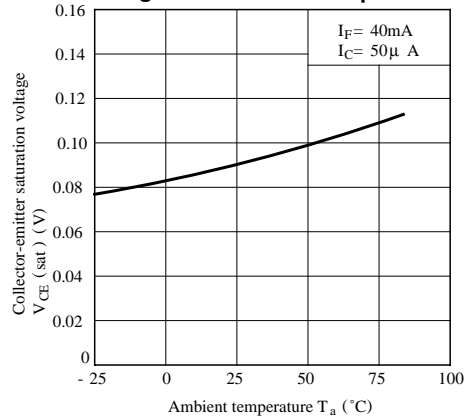
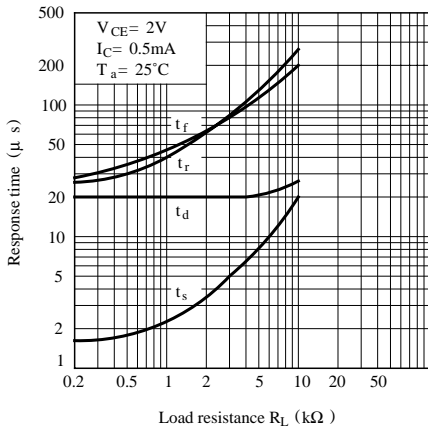

Fig. 9 Response Time vs. Load Resistance



Test Circuit for Response Time

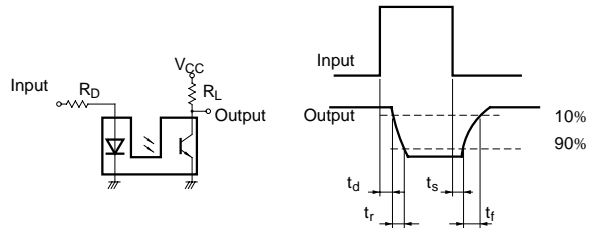

Fig.10 Frequency Response

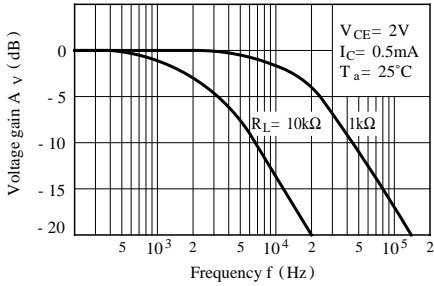

Fig.11 Collector Dark Current vs. Ambient Temperature

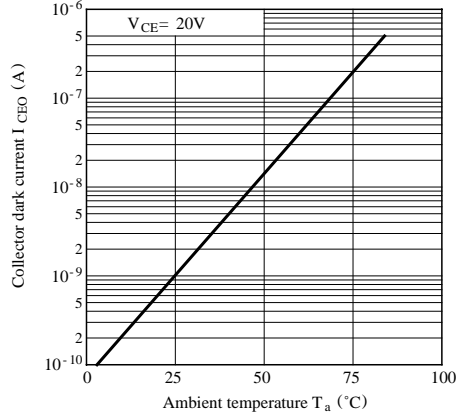

Fig.12 Relative Collector Current vs. Shield Distance (1)

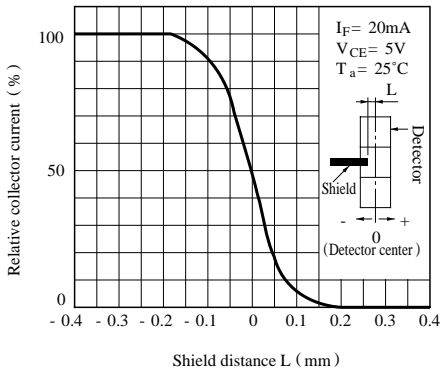
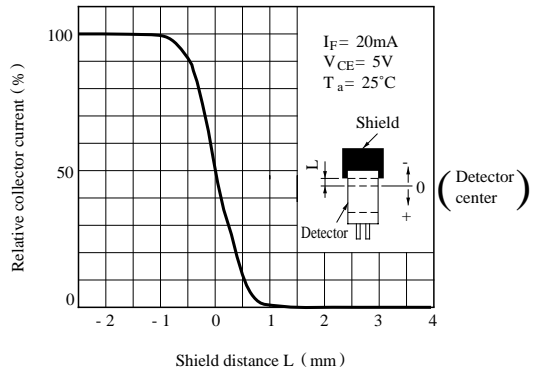

Fig.13 Relative Collector Current vs. Shield Distance (2)



● Please refer to the chapter “Precautions for Use” (Page 78 to 93).