



GaAs InGaP HBT MMIC ULTRA LOW PHASE NOISE, DISTRIBUTED AMPLIFIER, 2 - 18 GHz

5

AMPLIFIERS - SMT

Typical Applications

The HMC606LC5 is ideal for:

- Radar, EW & ECM
- Microwave Radio
- Test Instrumentation
- Military & Space
- Fiber Optic Systems

Features

- Ultra Low Phase Noise: -160 dBc/Hz @ 10 kHz
- P1dB Output Power: +15 dBm
- Gain: 13.5 dB
- Output IP3: +27 dBm
- Supply Voltage: +5V @ 64 mA
- 50 Ohm Matched Input/Output
- 25mm² Leadless SMT Package

Functional Diagram

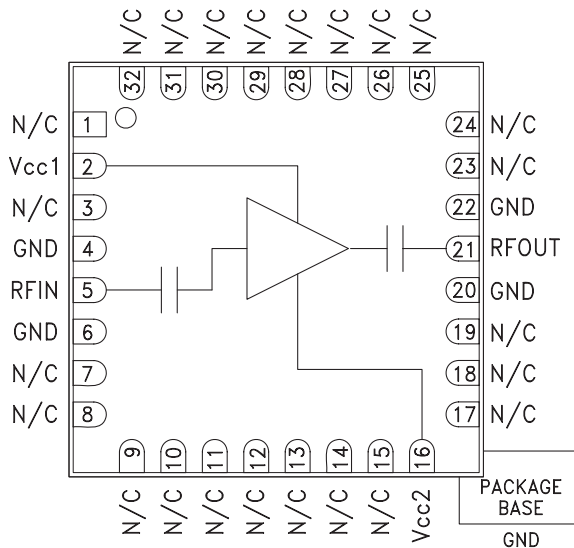

General Description

The HMC606LC5 is a GaAs InGaP HBT MMIC Distributed Amplifier housed in a leadless 5 x 5 mm surface mount package which operates between 2 and 18 GHz. With an input signal of 12 GHz, the amplifier provides ultra low phase noise performance of -160 dBc/Hz at 10 kHz offset, representing a significant improvement over FET-based distributed amplifiers. The HMC606LC5 provides 13.5 dB of small signal gain, +27 dBm output IP3 and +15 dBm of output power at 1 dB gain compression while requiring 64 mA from a +5V supply. The HMC606LC5 amplifier I/Os are internally matched to 50 Ohms and are internally DC blocked.

Electrical Specifications, $T_A = +25^\circ\text{C}$, $V_{cc1} = V_{cc2} = 5\text{V}$

Parameter	Min.	Typ.	Max.	Min.	Typ.	Max.	Units
Frequency Range	2 - 12			2 - 18			GHz
Gain	10.5	13.5		9.5	12.5		dB
Gain Flatness		±1.0			±1.0		dB
Gain Variation Over Temperature		0.021			0.024		dB/°C
Noise Figure		5			7		dB
Input Return Loss		20			18		dB
Output Return Loss		15			15		dB
Output Power for 1 dB Compression (P1dB)	12	15		10	13		dBm
Saturated Output Power (Psat)		17			15		dBm
Output Third Order Intercept (IP3)		27			22		dBm
Phase Noise @ 100 Hz		-140			-140		dBc/Hz
Phase Noise @ 1 kHz		-150			-150		dBc/Hz
Phase Noise @ 10 kHz		-160			-160		dBc/Hz
Phase Noise @ 1 MHz		-170			-170		dBc/Hz
Supply Current		64	80		64	80	mA

For price, delivery, and to place orders, please contact Hittite Microwave Corporation:
 20 Alpha Road, Chelmsford, MA 01824 Phone: 978-250-3343 Fax: 978-250-3373
 Order On-line at www.hittite.com

GaAs InGaP HBT MMIC ULTRA LOW PHASE NOISE, DISTRIBUTED AMPLIFIER, 2 - 18 GHz

Gain & Return Loss

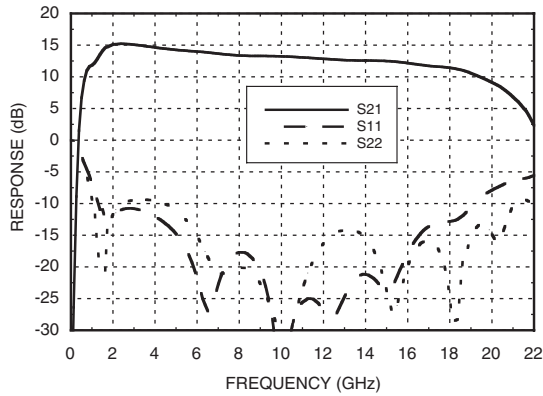

Gain vs. Temperature

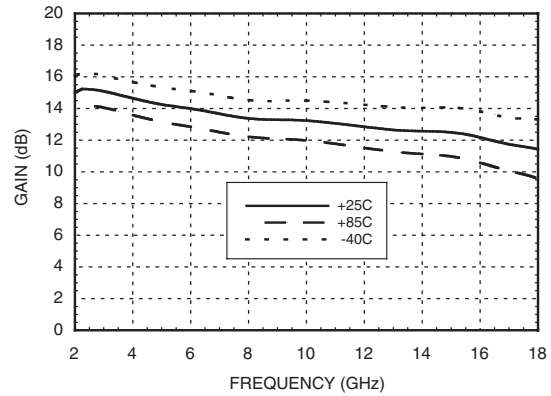

Input Return Loss vs. Temperature

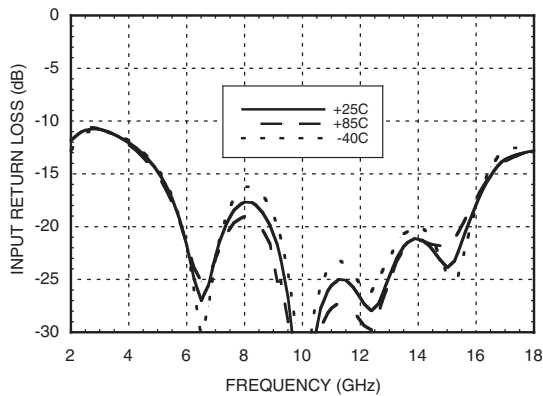

Output Return Loss vs. Temperature

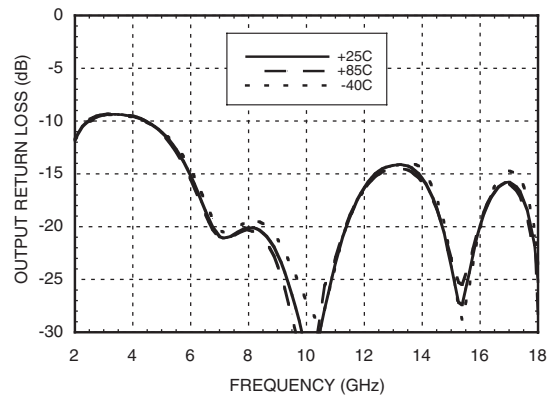

Power Compression

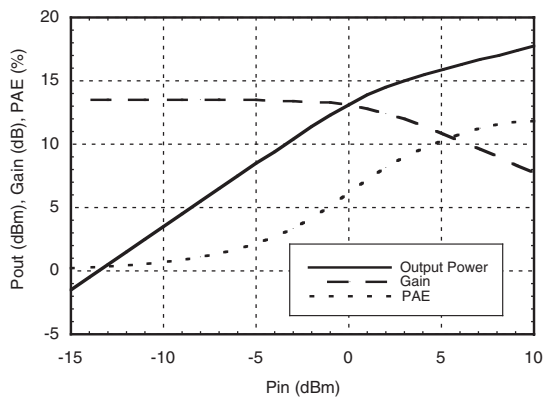

Noise Figure vs. Temperature

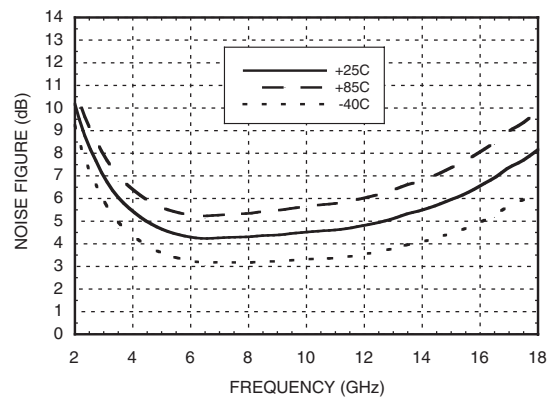

GaAs InGaP HBT MMIC ULTRA LOW PHASE NOISE, DISTRIBUTED AMPLIFIER, 2 - 18 GHz

P1dB vs. Temperature

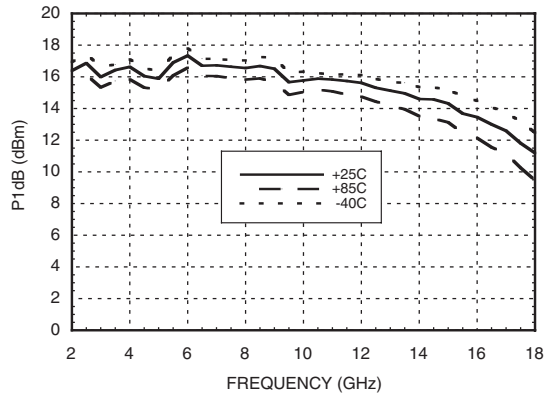

Psat vs. Temperature

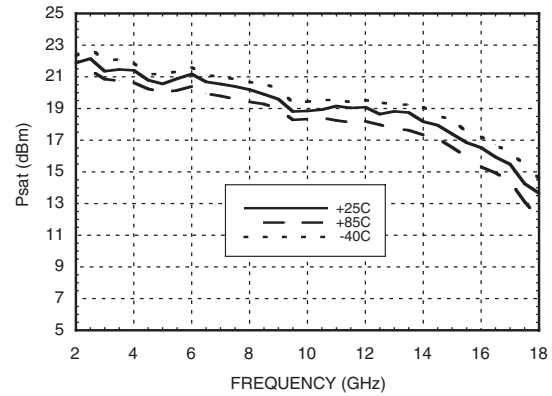

Output IP3 vs. Temperature

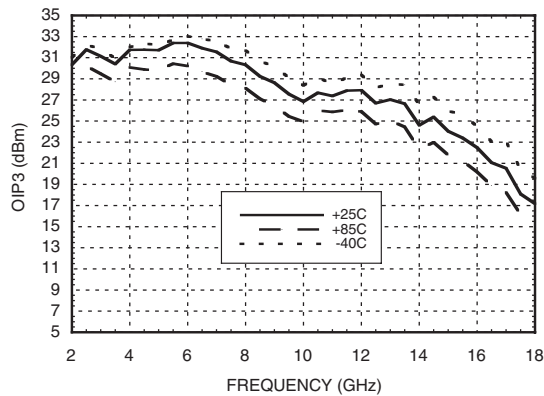

Phase Noise @ 12 GHz

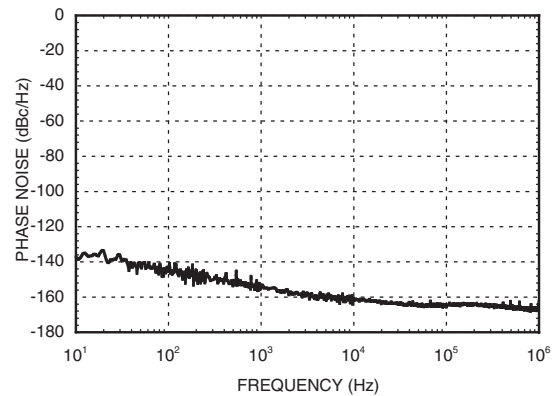

Phase Noise at P1dB @ 12 GHz

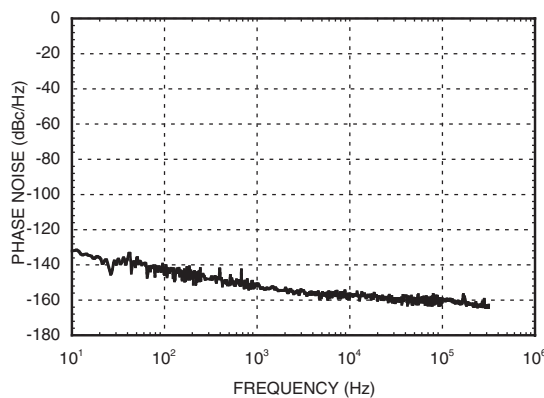

Phase Noise at Psat @ 12 GHz

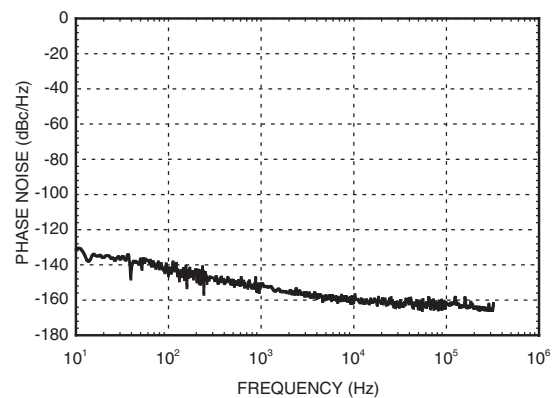

GaAs InGaP HBT MMIC ULTRA LOW PHASE NOISE, DISTRIBUTED AMPLIFIER, 2 - 18 GHz

Absolute Maximum Ratings

Vcc1= Vcc2= 5V	7V
RF Input Power (RFin)	+15 dBm
Channel Temperature	175 °C
Continuous Pdiss (T = 85 °C) (derate 6 mW/°C above 85 °C)	0.55 W
Thermal Resistance (channel to ground paddle)	169.5 °C/W
Storage Temperature	-65 to +150 °C
Operating Temperature	-40 to +85 °C

Typical Supply Current vs. Vcc1, Vcc2

Vcc, Vcc2 (V)	Icc + Icc2 (mA)
+4.5	53
+5.0	64
+5.5	71



ELECTROSTATIC SENSITIVE DEVICE
OBSERVE HANDLING PRECAUTIONS

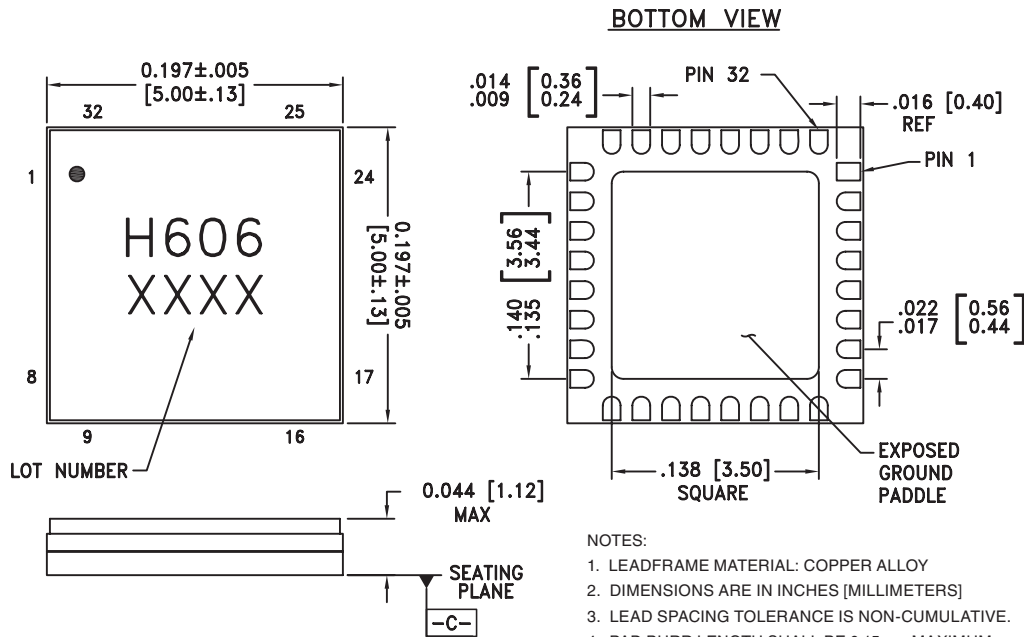

Outline Drawing



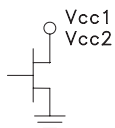

**GaAs InGaP HBT MMIC ULTRA LOW
PHASE NOISE, DISTRIBUTED AMPLIFIER, 2 - 18 GHz**

5
AMPLIFIERS - SMT
Pin Descriptions

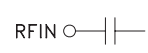
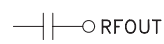
Pin Number	Function	Description	Interface Schematic
1, 3, 7 - 15, 17 - 19, 23 - 32	N/C	No connection. These pins may be connected to RF ground. Performance will not be affected.	
2, 16	Vcc1, Vcc2	Vcc1= Vcc2= 5V. Power supply voltage for the amplifier.	
4, 6, 20, 22, Ground Paddle	GND	Ground paddle must be connected to RF/DC ground.	
5	RFIN	This pin is AC coupled and matched to 50 Ohms from 2 - 18 GHz.	
21	RFOUT	This pin is AC coupled and matched to 50 Ohms from 2 - 18 GHz.	

**GaAs InGaP HBT MMIC ULTRA LOW
PHASE NOISE, DISTRIBUTED AMPLIFIER, 2 - 18 GHz**

Evaluation PCB

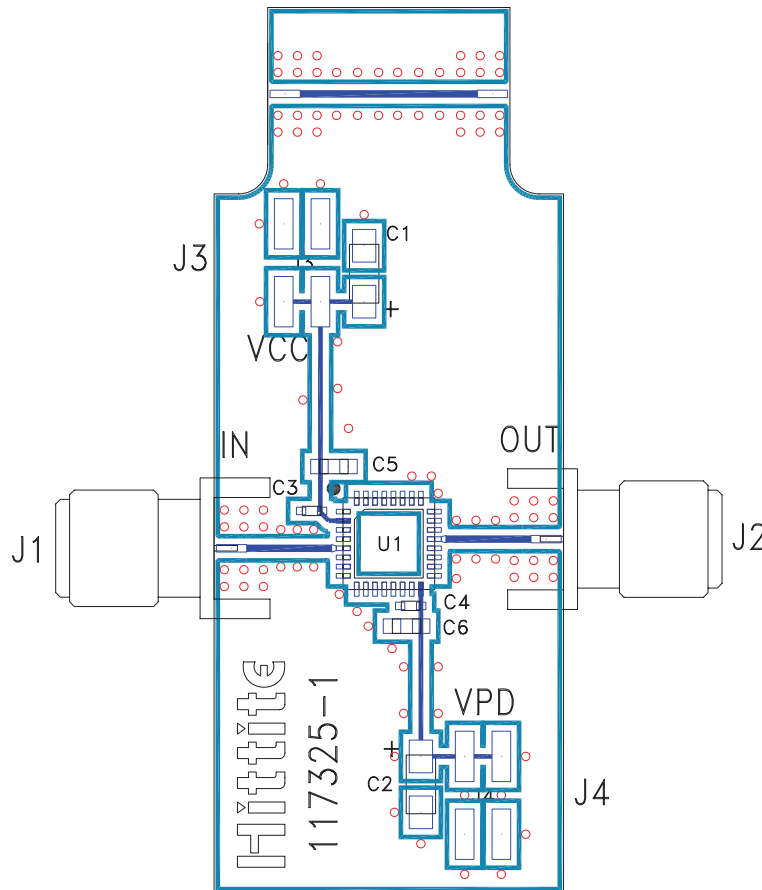

List of Materials for Evaluation PCB 117156 [1]

Item	Description
J1 - J2	SRI K Connector
J3 - J4	2mm Molex Header
C1, C2	4.7 µF Capacitor, Tantalum
C3, C4	100 pF Capacitor, 0402 Pkg.
C5, C6	1000 pF Capacitor, 0603 Pkg.
U1	HMC465LP5 / HMC465LP5E
PCB [2]	117325 Evaluation PCB

[1] Reference this number when ordering complete evaluation PCB

[2] Circuit Board Material: Rogers 4350

The circuit board used in the final application should use RF circuit design techniques. Signal lines should have 50 ohm impedance while the package ground leads and package bottom should be connected directly to the ground plane similar to that shown. A sufficient number of via holes should be used to connect the top and bottom ground planes. The evaluation board should be mounted to an appropriate heat sink. The evaluation circuit board shown is available from Hittite upon request.