

SP6T Absorptive RF Switch

Features

- High Isolation Of > 40 dB @ 2 GHz
- Low Insertion Loss Of 1.9 dB @ 2 GHz
- DC To 3000 MHz Operating Frequency
- Integrated CMOS Control Logic
- Integrated ESD Protection on Digital I/O
- Single Positive Supply Voltage
- Ultra Small LPCC™ Packaging
- Impedance matched to 75 Ohm systems

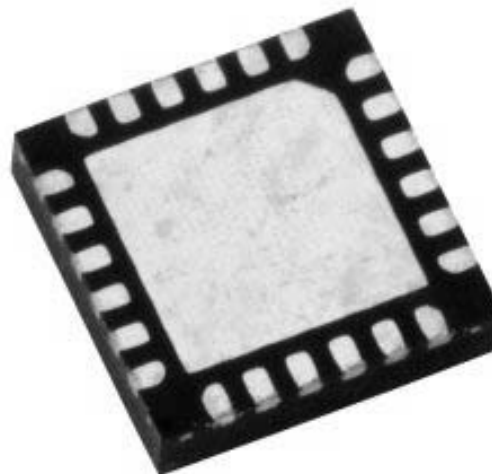

HRF-SW1031 in LPCC™ Package

Product Description

The Honeywell HRF-SW1031 is a high performance single pole six throw (SP6T) absorptive RF switch that is ideal for use in wireless basestation and handset applications that require minimum power and minimum insertion loss.

The HRF-SW1031 is manufactured with Honeywell's patented Silicon On Insulator (SOI) CMOS technology, which provides the performance of GaAs with the economy and integration capabilities of conventional CMOS technology.

RF Electrical Specifications @ + 25°C

Results @ Vdd = 5.0 +/- 10%, Vss = 0 unless otherwise stated, Z0 = 75 ohms

Parameter	Test Condition	Frequency	Minimum	Typical	Maximum	Units
Insertion Loss		DC – 1.0 GHz		1.7		dB
		2.0 GHz		1.9		dB
		3.0 GHz		2.4		dB
Isolation		DC – 1.0 GHz		54		dB
		2.0 GHz		41		dB
		3.0 GHz		33		dB
VSWR*		DC – 0.5 GHz		1.1:1		Ratio
		0.5 – 2.0 GHz		1.4:1		Ratio
		2.0 – 3.0 GHz		1.9:1	2.1:1	Ratio
1dB Compression	Input Power	Vss=Gnd	1.0 GHz	19		dBm
		Vss= -3	1.0 GHz	28		dBm
Input IP3	Two-Tone Inputs Up To + 5 dBm	Vss= Gnd	2.0 GHz	35		dBm
		Vss= -3	2.0 GHz	>35		dBm
Trise, Tfall*	10% To 90%			10		nS
Ton, Toff	50% Cntl To 90%/10%Rf			20		nS
Transients	In-Band			10		mV

*By design

DC Electrical Specifications @ + 25°C

Parameter	Minimum	Typical	Maximum	Units
Single V _{DD} Supply Voltage	3.3*	5.0	5.5	V
CMOS Logic Level (0)	0		0.8	V
CMOS Logic Level (1)	V _{DD} - 0.8		V _{DD}	V
Input Leakage Current			10	uA

*Note, performance curves are for Vdd = +5.0 +/- 10%

Absolute Maximum Ratings¹

Parameter	Absolute Maximum	Units
V _{DD}	+6.0	V
V _{in} Digital Logic 0	V _{ss} - 0.6	V
V _{in} Digital Logic 1	V _{dd} + 0.6	V
Maximum Input Power	> 35	dBm
ESD Voltage	400	V
Operating Temperature Range	+85	Degrees C
Storage Temperature Range	+125	Degrees C

(Note 1) Operation beyond any of these parameters may cause permanent damage.

Latch-Up: Unlike conventional CMOS RF switches, Honeywell's HRF-SW1031 is immune to latch-up.

ESD Protection: Although this device contains ESD protection circuitry on all digital inputs, conventional precautions should be taken to ensure that the Absolute Maximum Ratings are not exceeded.

Package Outline Drawing

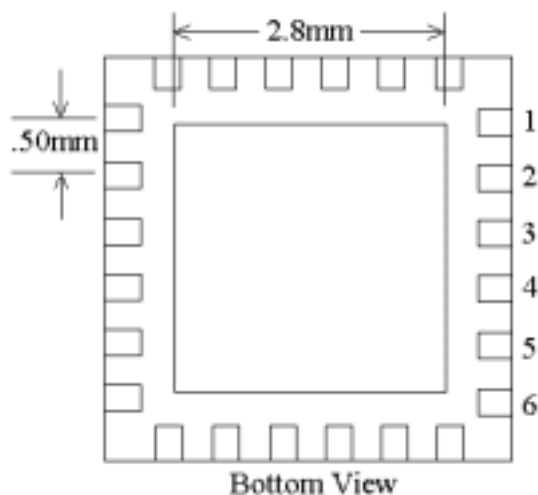

Bottom View, 24 Pin 4X4 mm LPCC™ Package
 ASAT LPCC Marketing Outline Dwg. # GMJ00004
 For more information see <http://www.asat.com>

Truth Table

C2	C1	C0	RF Output 1	RF Output 2	RF Output 3	RF Output 4	RF Output 5	RF Output 6
0	0	1	RFINPUT					
0	1	0		RFINPUT				
0	1	1			RFINPUT			
1	0	0				RFINPUT		
1	0	1					RFINPUT	
1	1	0						RFINPUT

"0" = CMOS Low, "1" = CMOS High

Note: For codes 000 and 111 all outputs are in the terminated isolation state.

Pin Configuration

Pin	Function	Pin	Function
1	GROUND	13	GROUND
2	GROUND	14	DIGITAL GROUND
3	RFOUTPUT5	15	RFOUTPUT2
4	GROUND	16	GROUND
5	GROUND	17	GROUND
6	RFOUTPUT4	18	RFOUTPUT1
7	VDD	19	GROUND
8	C2	20	GROUND
9	C1	21	RFINPUT
10	C0	22	GROUND
11	VSS	23	GROUND
12	RFOUTPUT3	24	RFOUTPUT6

Evaluation Circuit Board Connections

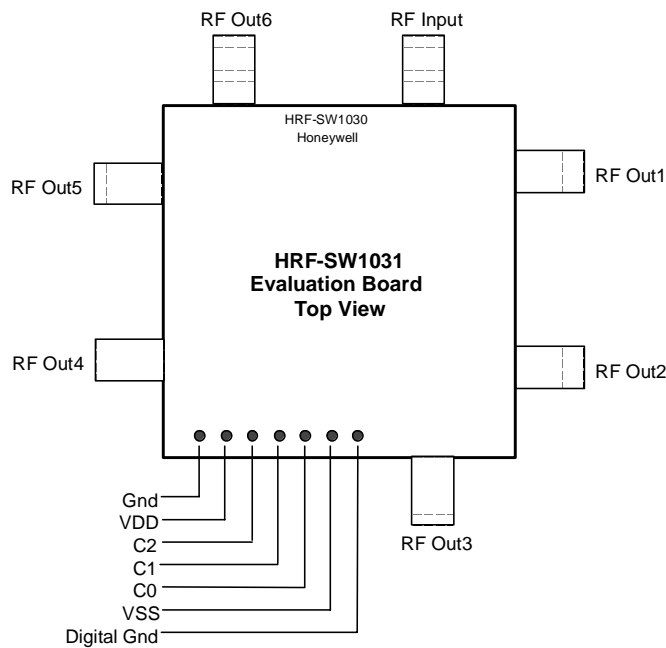

"0" = CMOS Low, "1" = CMOS High

Note:
HRF-SW1031 is the Z0 = 75 ohm version of the SW1030 evaluation board.

Performance Curves

Insertion Loss

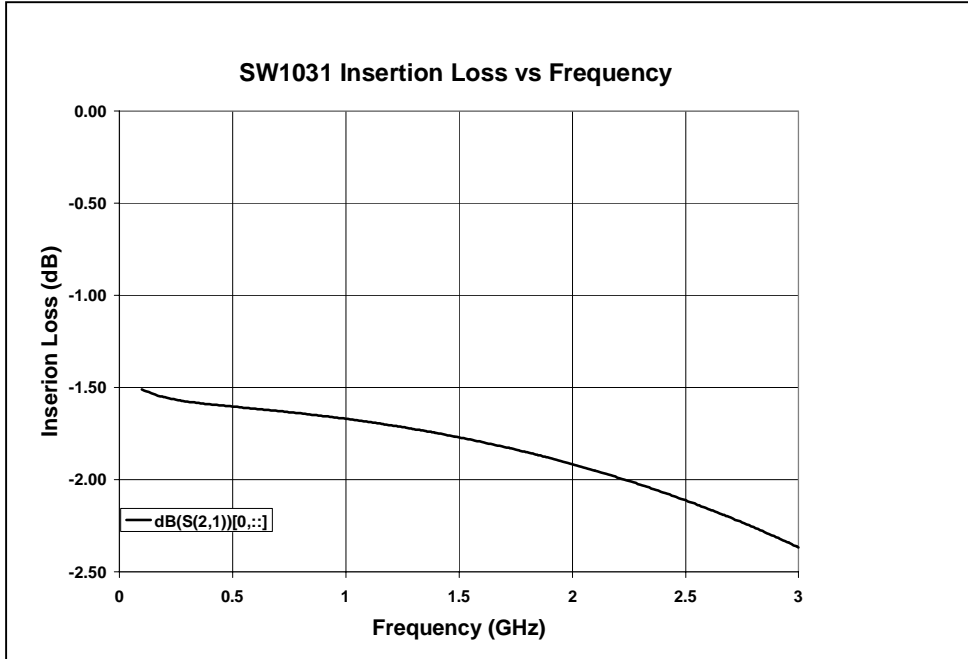

Isolation

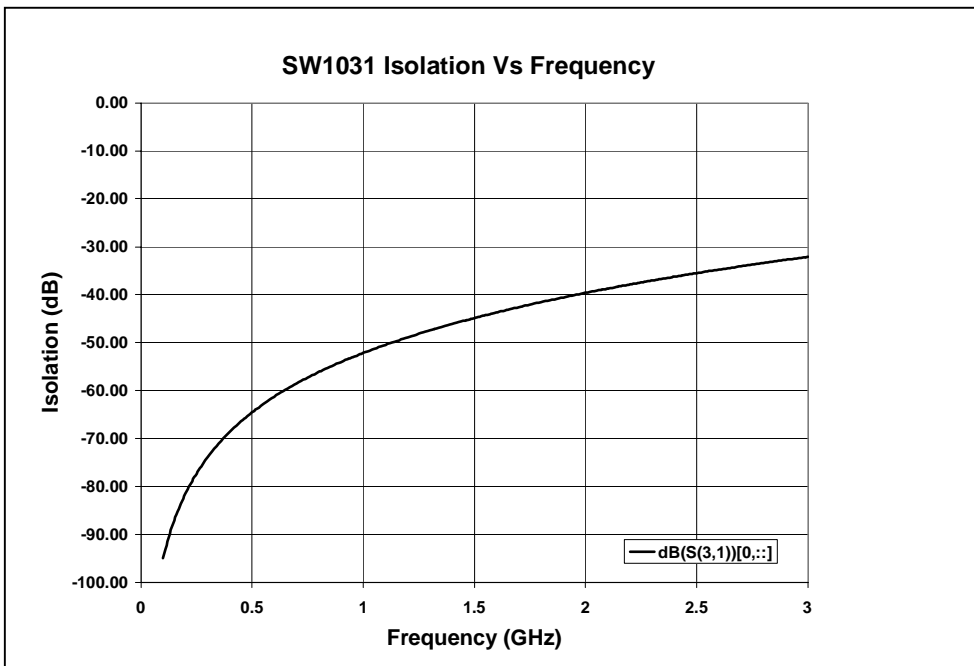

Return Loss

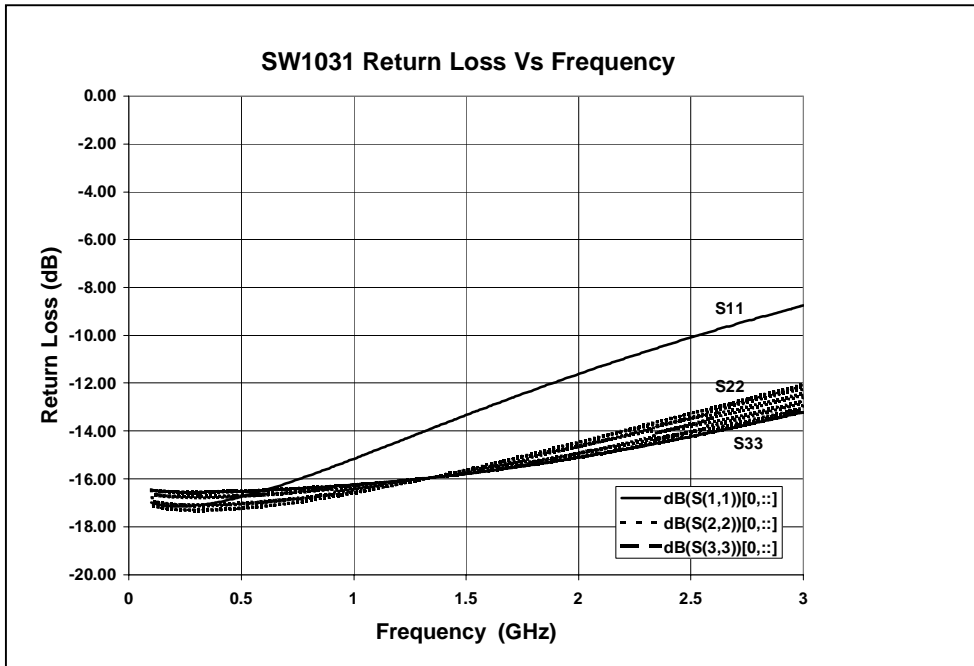

P1dB

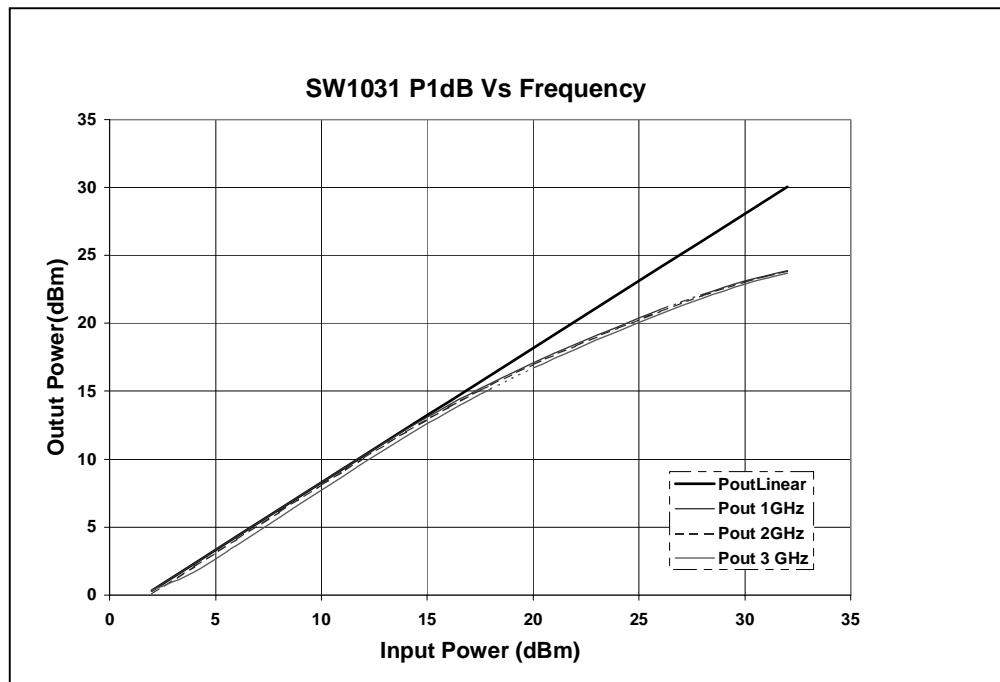

Evaluation Circuit Board

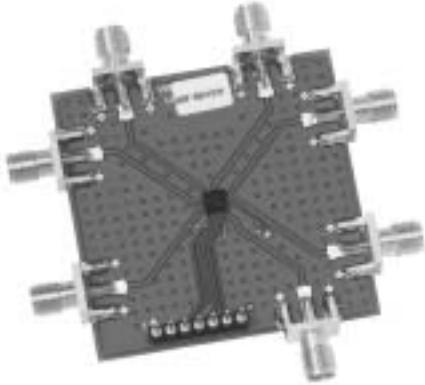

HRF-SW1031 Evaluation Board

Honeywell's evaluation board provides an easy to use method of evaluating the RF performance of our switch. Simply connect power, DC and RF signals to be measuring switch performance in less than 10 minutes.

Evaluation Circuit Board Layout Design Details

Item	Description
PCB	Impedance Matched Multi-Layer FR4
Switch	HRF-SW1031 RF Switch
Chip Capacitor	Panasonic Model ECU-E1C103KBQ Capacitor, .01uf 0402 10% 16V
RF Connector	Johnson Connectors Model 142-0701-801 SMA RF Coaxial Connector
DC Pin	Mil-Max Model 800-10-064-10-001 Header Pins

Ordering Information

Ordering Number	Product
HRF-SW1031-B	Delivered In Chip Tubes
HRF-SW1031-TR	Delivered On Tape And Reel ²
HRF-SW1031-E	Engineering Evaluation Board

(Note 2) Contact Honeywell for details

LPCC™ is a registered Trademark of ASAT Ltd.

Honeywell reserves the right to make changes to improve reliability, function or design. Honeywell does not assume any liability arising out of the application or use of any product or circuit described herein; neither does it convey any license under its patent rights nor the rights of others.