

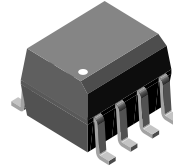

Optocoupler, Phototransistor Output, With Base Connection in SOIC-8 package

Features

- Isolation Voltage, 3000 V_{RMS}
- Industry Standard SOIC-8A Surface Mountable Package
- Compatible with Dual Wave, Vapor Phase and IR Reflow Soldering
- Lead-free component
- Component in accordance to RoHS 2002/95/EC and WEEE 2002/96/EC



1179002

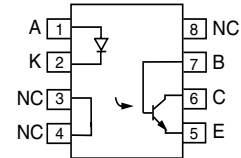

Agency Approvals

- UL1577, File No. E52744 System Code Y
- DIN EN 60747-5-2 (VDE0884)
DIN EN 60747-5-5 pending
Available with Option 1

In addition to eliminating through-holes requirements, this package conforms to standards for surface mounted devices.

A choice of 20, 50, and 100 % minimum CTR at I_F = 10 mA makes these optocouplers suitable for a variety of different applications.

Description

The IL211AT/ IL212AT/ IL213AT are optically coupled pairs with a Gallium Arsenide infrared LED and silicon NPN phototransistor. Signal information, including a DC level, can be transmitted by the device while maintaining a high degree of electrical isolation between input and output. The IL211AT/ IL212AT/ IL213AT comes in a standard SOIC-8 small outline package for surface mounting which makes it ideally suited for high density applications with limited space.

Order Information

Part	Remarks
IL211AT	CTR > 20 %, SOIC-8
IL212AT	CTR > 50 %, SOIC-8
IL213AT	CTR > 100 %, SOIC-8

Available only on Tape and Reel Option
(Conforms to EIA Standard RS481A)

For additional information on the available options refer to Option Information.

Absolute Maximum Ratings

T_{amb} = 25 °C, unless otherwise specified

Stresses in excess of the absolute Maximum Ratings can cause permanent damage to the device. Functional operation of the device is not implied at these or any other conditions in excess of those given in the operational sections of this document. Exposure to absolute Maximum Rating for extended periods of the time can adversely affect reliability.

Input

Parameter	Test condition	Symbol	Value	Unit
Peak reverse voltage		V _R	6.0	V
Forward continuous current		I _F	60	mA
Power dissipation		P _{diss}	90	mW
Derate linearly from 25 °			1.2	mW/°C

Output

Parameter	Test condition	Symbol	Value	Unit
Collector-emitter breakdown voltage		BV_{CEO}	30	V
Emitter-collector breakdown voltage		BV_{ECO}	7.0	V
Collector-base breakdown voltage		V_{CEO}	70	V
$I_{CMAX DC}$		$I_{CMAX DC}$	50	mA
I_{CMAX}	$t < 1.0$ ms	I_{CMAX}	100	mA
Power dissipation		P_{diss}	150	mW
Derate linearly from 25 °C			2.0	mW/°C

Coupler

Parameter	Test condition	Symbol	Value	Unit
Total package dissipation	(LED + Detector)	P_{tot}	240	mW
Derate linearly from 25 °C			3.2	mW/°C
Storage temperature		T_{stg}	- 55 to +150	°C
Operating temperature		T_{amb}	- 55 to +100	°C
Soldering time at 260 °C			10	sec.

Electrical Characteristics

$T_{amb} = 25$ °C, unless otherwise specified

Minimum and maximum values are testing requirements. Typical values are characteristics of the device and are the result of engineering evaluation. Typical values are for information only and are not part of the testing requirements.

Input

Parameter	Test condition	Symbol	Min	Typ.	Max	Unit
Forward voltage	$I_F = 10$ mA	V_F		1.3	1.5	V
Reverse current	$V_R = 6.0$ V	I_R		0.1	100	μA
Capacitance	$V_R = 0$	C_O		13		pF

Output

Parameter	Test condition	Symbol	Min	Typ.	Max	Unit
Collector-emitter breakdown voltage	$I_C = 10$ μA	BV_{CEO}	30			V
Emitter-collector breakdown voltage	$I_E = 10$ μA	BV_{ECO}	7.0			V
Collector dark current	$V_{CE} = 10$ V	I_{CEO}		5.0	50	nA
Collector-emitter capacitance	$V_{CE} = 0$	C_{CE}		10		pF

Coupler

Parameter	Test condition	Symbol	Min	Typ.	Max	Unit
Saturation voltage, collector-emitter	$I_F = 10$ mA	V_{CEsat}			0.4	V
Isolation test voltage	1 sec.	V_{ISO}	3000			V_{RMS}
Capacitance (input-output)		C_{IO}		0.5	50	pF
Resistance input to output		R_{IO}		100		GΩ
Collector-emitter breakdown voltage	$I_C = 10$ μA	BV_{CEO}	30			V

Current Transfer Ratio

Parameter	Test condition	Part	Symbol	Min	Typ.	Max	Unit
Current Transfer Ratio	$I_F = 10 \text{ mA}$, $V_{CE} = 5.0 \text{ V}$	IL211AT	CTR	20	50		%
		IL212AT	CTR	50	80		%
		IL213AT	CTR	100	130		%

Switching Characteristics

Parameter	Test condition	Symbol	Min	Typ.	Max	Unit
Switching time	$I_C = 2 \text{ mA}$, $R_L = 100 \Omega$, $V_{CC} = 10 \text{ V}$	t_{on} , t_{off}		3.0		μs

Typical Characteristics ($T_{amb} = 25^\circ\text{C}$ unless otherwise specified)

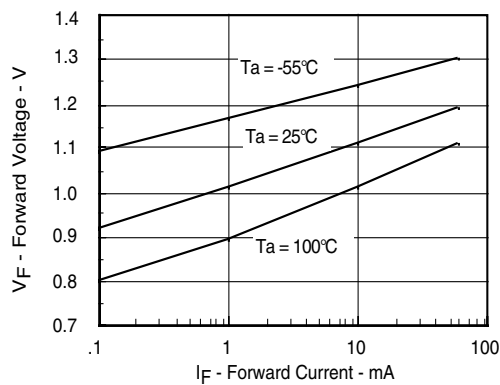

#211at_01

Figure 1. Forward Voltage vs. Forward Current

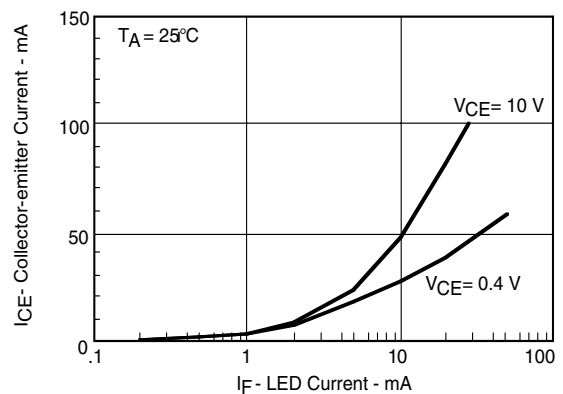

#211at_03

Figure 3. Collector-Emitter Current vs. LED Current

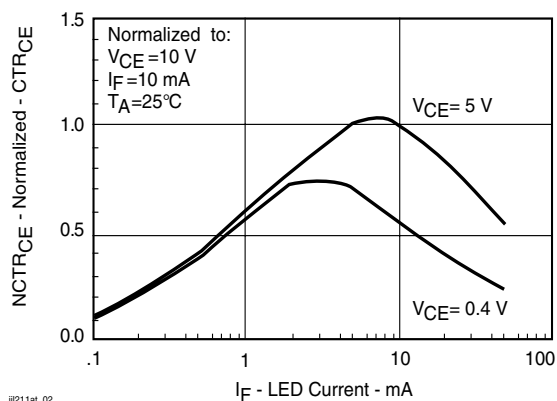

#211at_02

Figure 2. Normalized Non-saturated and Saturated CTR_{CE} vs. LED Current

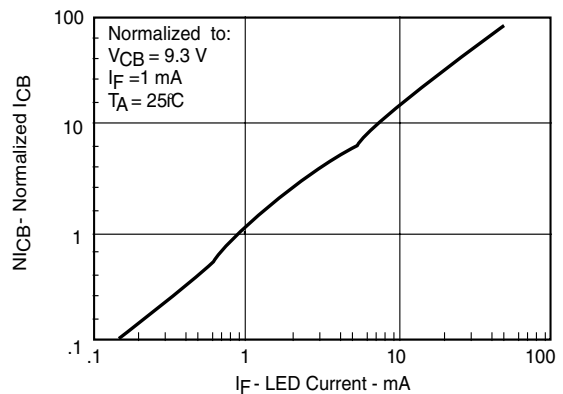

#211at_04

Figure 4. Normalized Collector-Base Photocurrent vs. LED Current

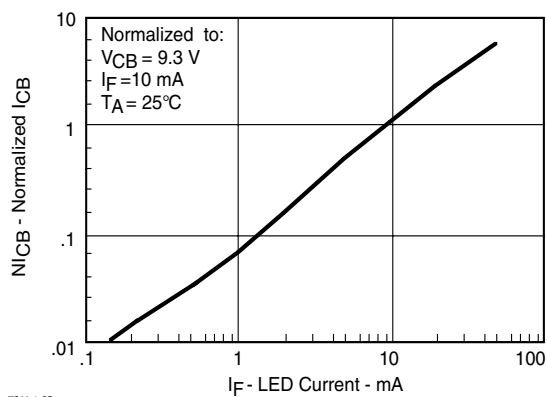

#211at_05

Figure 5. Normalized Collector-Base Photocurrent vs. LED Current

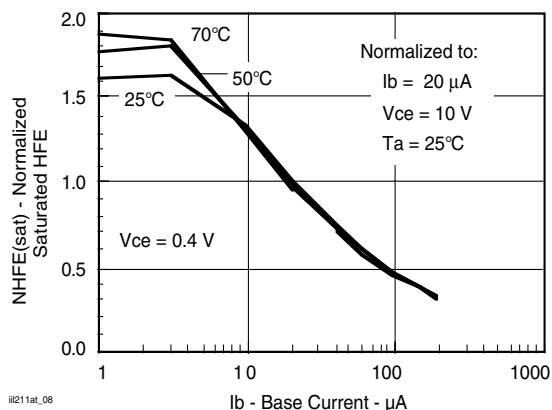

#211at_08

Figure 8. Normalized Saturated HFE vs. Base Current and Temperature

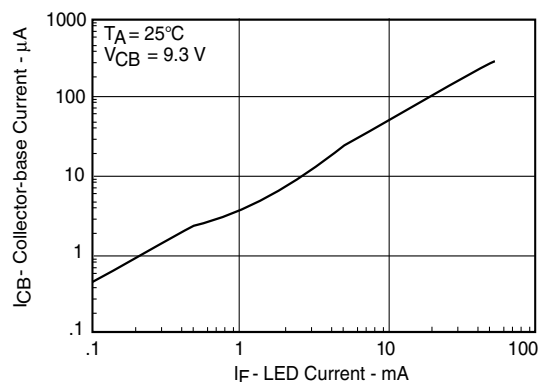

#211at_06

Figure 6. Collector-Base Photocurrent vs. LED Current

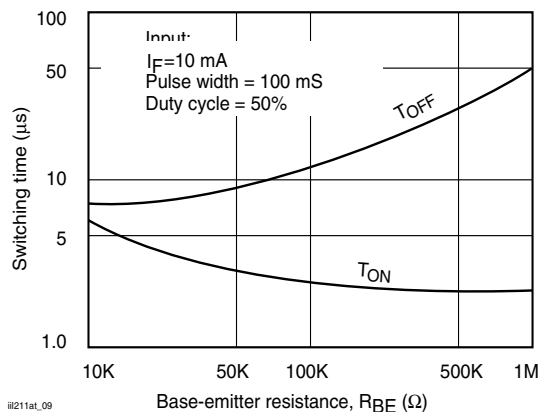

#211at_09

Figure 9. Typical Switching Characteristics vs. Base Resistance (Saturated Operation)

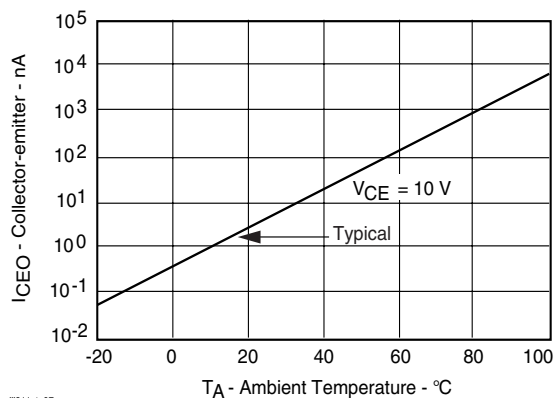

#211at_07

Figure 7. Collector-Emitter Leakage Current vs. Temp.

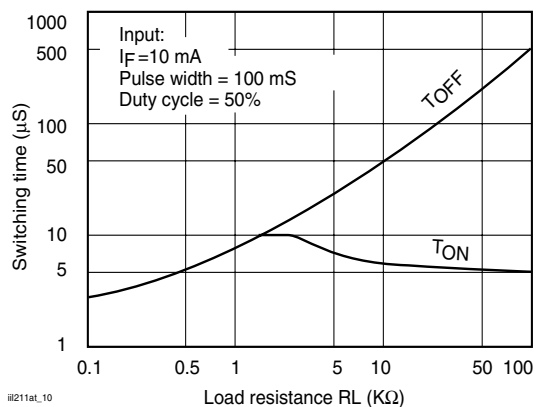

#211at_10

Figure 10. Typical Switching Times vs. Load Resistance

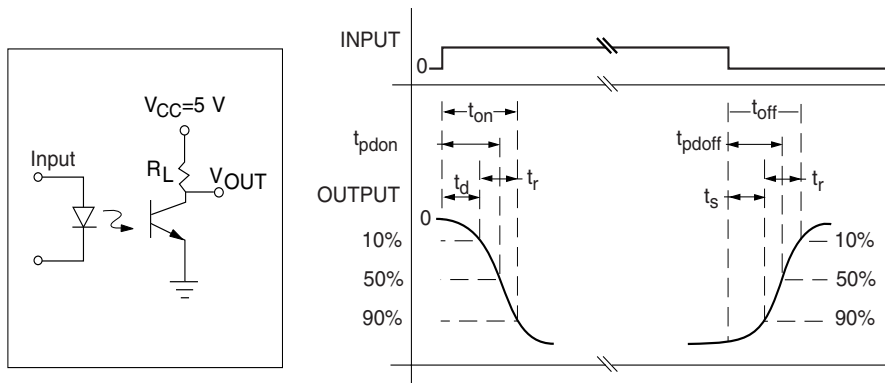

il211at_11

Figure 11. Switching Test Circuit

Package Dimensions in Inches (mm)

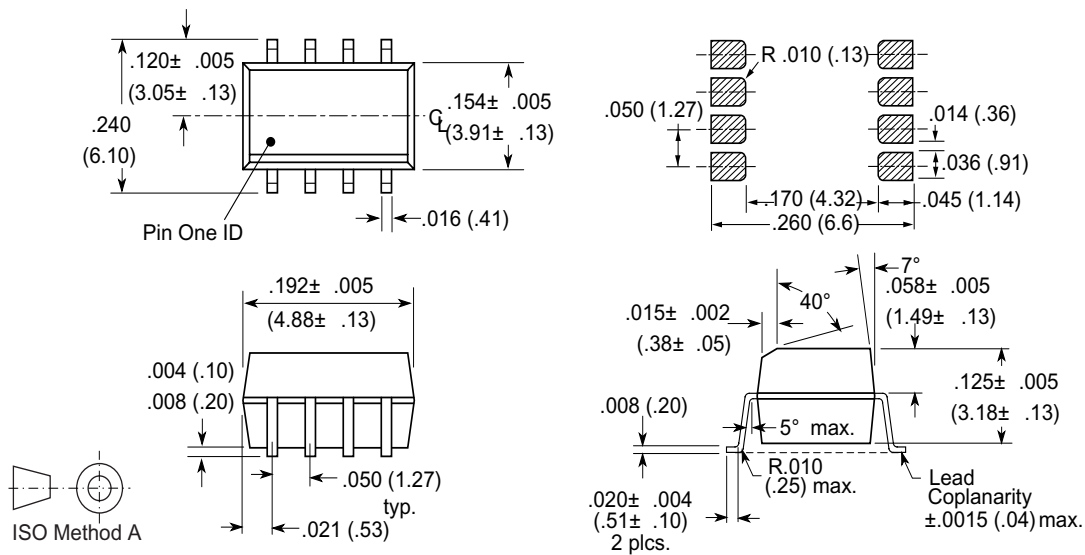

i178003

Ozone Depleting Substances Policy Statement

It is the policy of Vishay Semiconductor GmbH to

1. Meet all present and future national and international statutory requirements.
2. Regularly and continuously improve the performance of our products, processes, distribution and operating systems with respect to their impact on the health and safety of our employees and the public, as well as their impact on the environment.

It is particular concern to control or eliminate releases of those substances into the atmosphere which are known as ozone depleting substances (ODSs).

The Montreal Protocol (1987) and its London Amendments (1990) intend to severely restrict the use of ODSs and forbid their use within the next ten years. Various national and international initiatives are pressing for an earlier ban on these substances.

Vishay Semiconductor GmbH has been able to use its policy of continuous improvements to eliminate the use of ODSs listed in the following documents.

1. Annex A, B and list of transitional substances of the Montreal Protocol and the London Amendments respectively
2. Class I and II ozone depleting substances in the Clean Air Act Amendments of 1990 by the Environmental Protection Agency (EPA) in the USA
3. Council Decision 88/540/EEC and 91/690/EEC Annex A, B and C (transitional substances) respectively.

Vishay Semiconductor GmbH can certify that our semiconductors are not manufactured with ozone depleting substances and do not contain such substances.

We reserve the right to make changes to improve technical design
and may do so without further notice.

Parameters can vary in different applications. All operating parameters must be validated for each customer application by the customer. Should the buyer use Vishay Semiconductors products for any unintended or unauthorized application, the buyer shall indemnify Vishay Semiconductors against all claims, costs, damages, and expenses, arising out of, directly or indirectly, any claim of personal damage, injury or death associated with such unintended or unauthorized use.

Vishay Semiconductor GmbH, P.O.B. 3535, D-74025 Heilbronn, Germany
Telephone: 49 (0)7131 67 2831, Fax number: 49 (0)7131 67 2423