

ILA1238NS

AM/FM MONO RECEIVER

ILA1238NS (analog of CXA1238S, SONY) - high-quality one-chip stereoreceiver designed for receipt of AM/FM signals of broadcasting stations. The receiver contains: high-frequency amplifiers and AM and FM mixers, AM and FM intermediate frequency amplifiers, AM and FM detectors, output decoder of stereosignal for coding system with pilot tone.

- Low consumption current (in FM mode $I_{cc}=12.5$ mA, in AM mode $I_{cc}=9.5$ mA at $U_{cc}=6$ V)
- LED indication of tuning
- LED indication of "STEREO" mode
- Switching-off noiseless FM tuning
- Small number of peripheral components

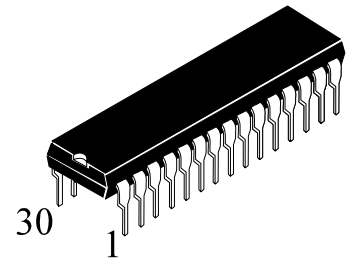

PACKAGE

30-pin mini-DIP

$T_A = -10^{\circ}\dots+70^{\circ}$ C

BLOCK DIAGRAM

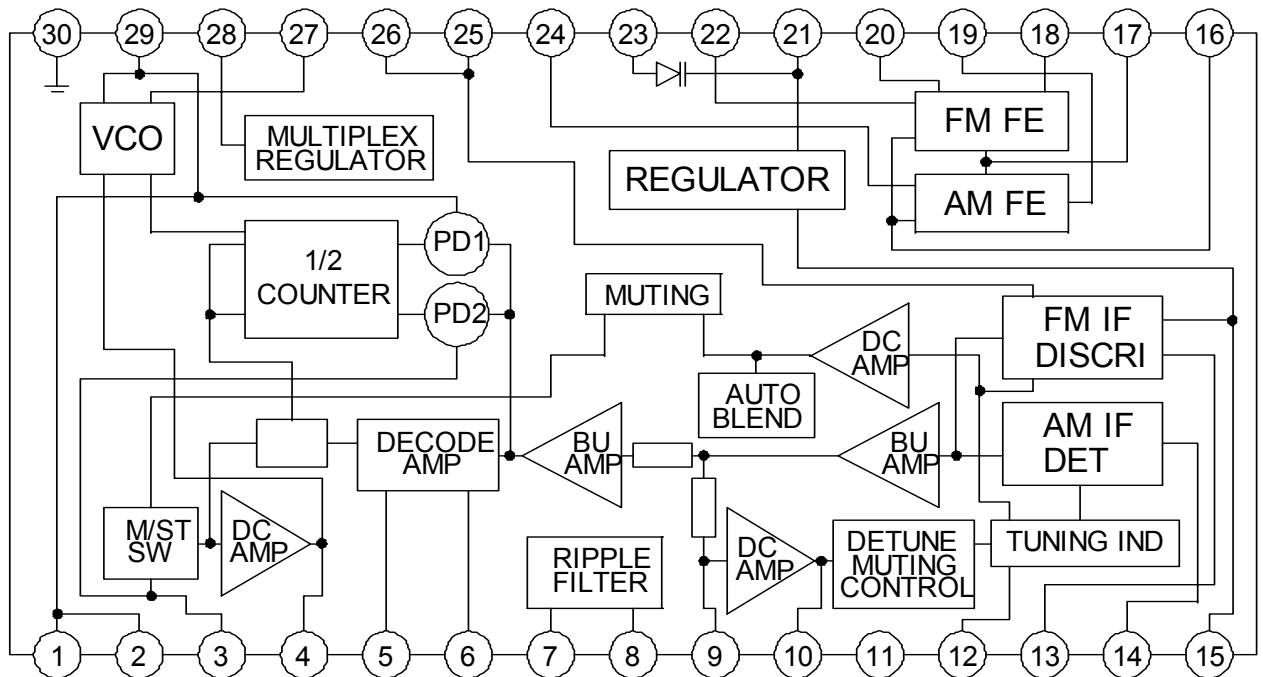

Note:

- VCO - voltage controlled oscillator,
- REGULATOR - reference voltage source,
- MULTIPLEX REGULATOR - reference voltage source for stereodecoder,
- FM FE - heterodyne oscillator, high frequency amplifier and FM path mixer,
- AM FE - heterodyne oscillator, high frequency amplifier and AM path mixer,
- FM IF DISCRI - intermediate frequency amplifier and FM path demodulator,
- AM IF DET - intermediate frequency amplifier and AM path detector,
- TUNING IND - tuning indicator driver,
- DETUNE MUTING CONTROL - muting control block,
- DC AMP - DC amplifier,
- BU AMP - buffer amplifier,
- M/ST SW - "MONO"- "STEREO" switch,
- DECODE AMP - decoder and LF signal amplifier,

ILA1238NS

RIPPLE FILTER - internal stress source with ripple filter,
 1/2 COUNTER - VCO frequency divider,
 PD1,PD2 - phase detectors of VCO frequency tuning
 AUTO BLEND - signal level block for VCO frequency tuning,
 MUTING - "MONO" and "STEREO" modes control block.

ABSOLUTE MAXIMUM RATINGS

Symbol	Parameter	Value	Unit
Ucc	Supply voltage	10	V
Topr	Operation temperature	-10 ... +70	°C
Tstg	Storage temperature	-55 ... +150	°C
Tjmax	Junction maximum temperature	125	°C
Pd	Allowable power dissipation	500	mW

RECOMMENDED OPERATION CONDITIONS

Symbol	Parameter	Value	Unit
Ucc	Supply voltage	2.0 ... 9.0	V

PINS DESCRIPTION

№	Symbol	Voltage, V				Equivalent electrical circuit	Description
		Ucc=3V		Ucc=6V			
		FM	AM	FM	AM		
1	PLL LPF1	0.86	0.86	0.86	0.86		Low frequency filter for VCO phase selftuning circuit
29	PLL LPF2	0.86	0.86	0.86	0.86		
2	PILOT DET LPF1	0.95	0.95	0.95	0.95		Pins for connecting capacitance of low frequency filter of pilot tone detector
3	PILOT DET LPF2	0.95	0.95	0.95	0.95		
4	ST IND VCO CHECK	1.6	1.6	4.5	4.5		Pin of indicator of "STEREO" mode and frequency control 76 kHz

ILA1238NS

PINS DESCRIPTION (CONTINUED)

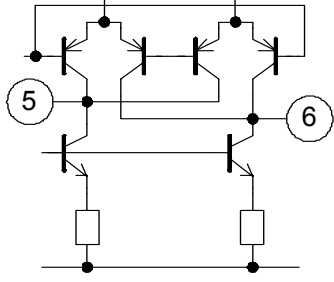
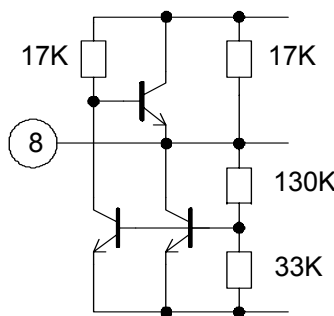
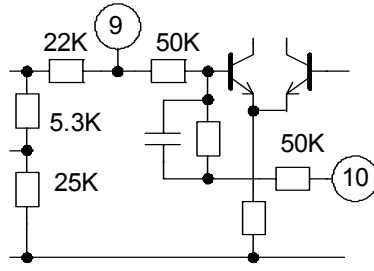
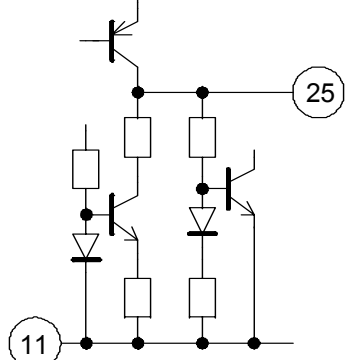
№	Symbol	Voltage, V				Equivalent circuit	Description
		U _{cc} =3V		U _{cc} =6V			
		FM	AM	FM	AM		
5	Rch OUT	1.25	1.45	1.35	2.0		Right channel pin
6	Lch OUT	1.25	1.45	1.35	2.0		Left channel pin
7	U _{cc}	3.0	3.0	6.0	6.0		Supply
8	Ripple FILTER	2.5	2.5	4.0	4.0		Internal voltage source filter
9	AGC/AFC1	1.47	1.15	1.47	1.15		Pins of heterodyne AFC filter for FM path and AGC for AM path
10	AGC/AFC2	1.15	1.47	1.15	1.47		
11	GND	0	0	0	0		Common output of paths IF FM, IF AM and detectors
25	MUTE	0.05	0.1	0.05	0.1		Connection pin of muting time constant capacitance

ILA1238NS

PINS DESCRIPTION (CONTINUED)

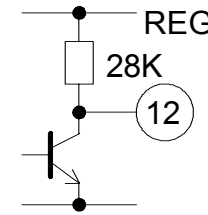
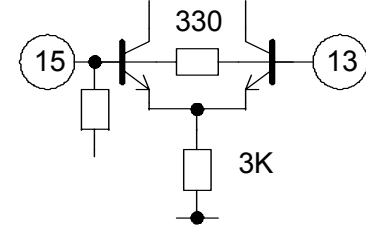
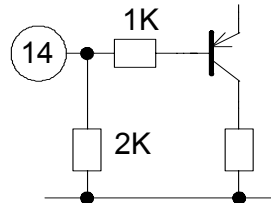
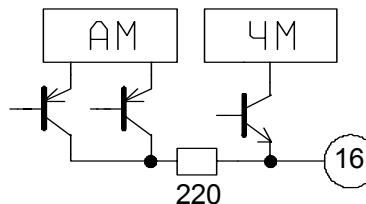
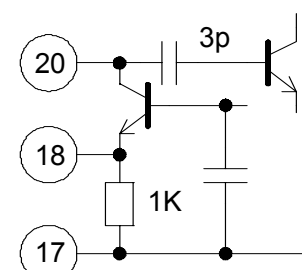
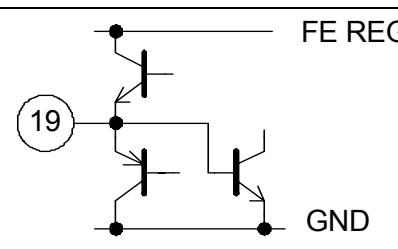
№	Symbol	Voltage, V				Equivalent circuit	Description
		U _{cc} =3V		U _{cc} =6V			
		FM	AM	FM	AM		
12	TUNE IND	1.6	1.6	4.5	4.5		Signal level indicator in FM and AM modes
13	FM IF IN	1.28	0	1.28	0		FM IF input Bands switching output: for AM - to be connected to common output, for FM - in free state
15	BAND SELECT	1.28	0	1.28	0		
14	AM IF IN	0	0	0	0		input pin of AM IF
16	FM/AM FE OUT	0.4	0.35	0.8	0.35		Output pin of FM IF and AM IF mixers
17	FE GND	0	0	0	0		Common output of AM RF and FM RF Input of FM RF amplifier Output of FM RF amplifier
18	FM RF IN	0.4	0	0.4	0		
20	FM RF	1.28	1.28	1.28	1.28		
19	AM RF IN	1.28	1.28	1.28	1.28		Input of AM RF

ILA1238NS

PINS DESCRIPTION (CONTINUED)

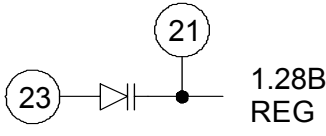
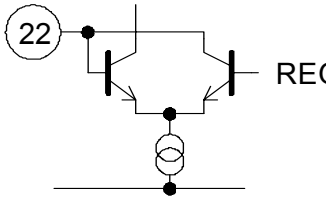
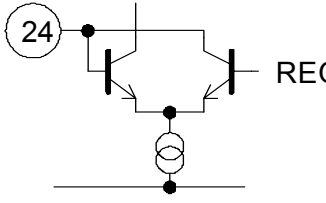
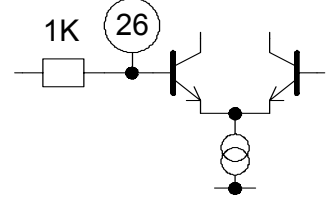
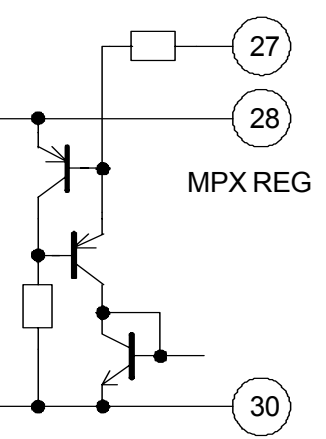
№	Symbol	Voltage, V				Equivalent circuit	Description
		U _{cc} =3V		U _{cc} =6V			
		FM	AM	FM	AM		
21	REG	1.28	1.28	1.28	1.28		Output of reference voltage source Output of AFC vericap
23	AFC						
22	FM OSC	1.28	1.28	1.28	1.28		FM heterodyne output
24	AM OSC	1.28	1.28	1.28	1.28		AM heterodyne output
26	FM DISCRI	2.0	2.70	3.08	3.80		Discriminator connection output
27	VCO						VCO control output for stereo-decoder Reference voltage output for stereo-decoder Common output for stereo-decoder
28	MPX REG	1.65	1.65	1.65	1.65		
30	GND	0	0	0	0		

ILA1238NS

ELECTRICAL CHARACTERISTICS (Ta=25°C, Ucc=6 V)

№	Parameter, unit	Symbol	Value		Test conditions
			Min.	Max.	
1	Consumption current in AM mode, mA	Icc1	5.0	12	Ucc=6.0 V
2	Consumption current in FM mode, mA	Icc2	7.0	15	Ucc=6.0 V
3	FM RF block voltage gain, dB	Au1	28	42	Ucc=6.0 V U _I =40 dBmKv f _i =100 MHz
4	FM IF sensitivity, dBmKv	S1	-	31	Ucc=6.0 V U _I =*1 f _i =10.7 MHz Df=22.5 kHz fm=1 kHz
5	FM IF input signal level when switching over "MONO" - "STEREO", dBmKv	V _{I1}	38	48	U _I =*2 f _i =10.7 MHz fm=1 kHz
6	FM IF input signal level when switching over "STEREO" - "MONO", dBmKv	V _{I3}	35	46	U _I =*3 f _i =10.7 MHz fm=1 kHz
7	Automixing, dBmKv	V _{I2}	1	41	f _i =10.7 MHz fm=1 kHz
8	FM IF frequency deviation of standard (*4), kHz	DF1	-50	50	U _I =90 dBmKv f _i =(10.7+0.05) MHz fm=1 kHz
9	Output current on tuning indicator output in FM mode, mA	Io2	1.8	7.0	U _I =60 dBmKv f _i =10.7 MHz
10	Output current on "STEREO" mode indicator output, mA	Io1	1.8	5.0	Ucc=6.0 V U _I =245 mV f _i =10.7 MHz fm=1 kHz
11	Output signal attenuation factor in MUTE mode, dB	A1	16	30	U _I =245 mV MONO fm=1 kHz
12	Channel separation ratio, dB	Cdnc	30	-	Ucc=6.0 V U _I =90 dBmKv f _i =10.7 MHz Df=22.5 kHz fm=1 kHz Modulation on R and L channels
13	Output voltage in FM "MONO" mode, mV	Uo1	35	138	Ucc=6.0 V U _I =90 dBmKv f _i =10.7 MHz Df=22.5 kHz fm=1 kHz
14	Output voltage in FM "STEREO" mode, mV	Uo2	20	138	Ucc=6.0 V U _I =90 dBmKv f _i =10.7 MHz Df=22.5 kHz fm=1 kHz

ILA1238NS

ELECTRICAL CHARACTERISTICS (Ta=25°C, Ucc=6 V) (continued)

№	Parameter, unit	Symbol	Value		Test conditions
			Min.	Max.	
15	Harmonic factor in FM "MONO" mode, %	Kh1	-	2.0	Ucc=6.0 V U _I =90 dBmKv f _i =10.7 MHz Df=75 kHz f _m =1 kHz
16	Harmonic factor in FM "STEREO" mode, %	Kh2	-	2.0	Ucc=6.0 V U _I =90 dBmKv f _i =10.7 MHz Df=75 kHz f _m =1 kHz
17	AM RF voltage gain, dB	AU2	19	28	U _I =60 dBmKv f _i =1660 kHz
18	Sensitivity (*5) of AM IF, dBmKv	S2	15	29	Ucc=6.0 V U _o =15.5 mV f _i =465 kHz f _m =1 kHz 30% MOD
19	Output current on tuning indicator output in AM mode, mA	I _{o3}	1.3	7.0	U _I =85 dBmKv f _i =465 kHz
20	Output voltage in AM mode, mV	U _{o3}	35	138	Ucc=6.0 V U _I =85 dBmKv f _i =465 kHz f _m =1 kHz 30% MOD
21	Harmonic factor in AM mode, %	Kh3	-	2.0	Ucc=6.0 V U _I =95 dBmKv f=1660 kHz f _m = 1kHz 30% MOD

Notes:

*1 - Input signal level must be within the limits, that the signal on output makes minus 3 dB of output signal at U_I=31.6 mB.

*2 - Input signal level is set equal to 0 mKv and then is raised up to the moment when "STEREO" mode indicator switches on.

*3 - Input signal level is set equal to 1 mV and then is reduced to the moment when "STEREO" mode indicator switches off.

*4 - Frequency deviation at which voltage constant on output 10 (AGC/AFC2) is equal to the voltage on output 21 (REG), of path central frequency (10.7 MHz).

*5 - Sensitivity means that signal level on AM IF input at which voltage on channel outputs is set equal to 15.5 mV (active value)

ILA1238NS

TYPICAL APPLICATION CIRCUIT

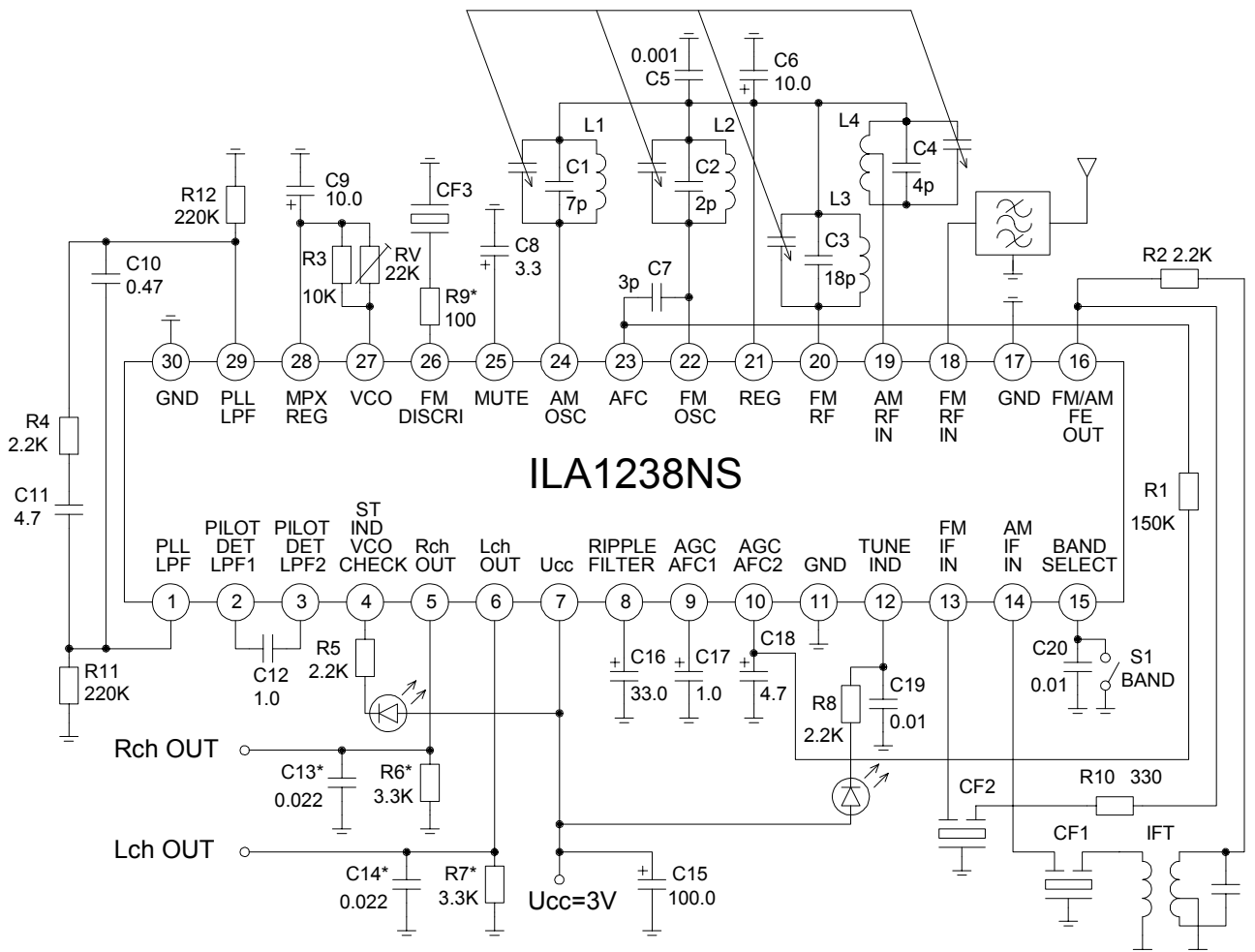

CF1 - filter 465 kHz, CF2 - filter 10.7 MHz,
 CF3 - piezoelectric discriminator,
 IFT - matching transformer for 465 kHz (parameters are given above).

Fig.10