

Miniature Type IRM(Lateral)

IRM-8608S

Features:

- LOW VOLTAGE AND LOW POWER CONSUMPTION.
- PHOTODIODE WITH INTEGRATED CIRCUIT.
- HIGH SENSITIVITY.
- TTL AND CMOS COMPATIBILITY.
- HIGH IMMUNITY AGAINST AMBIENT LIGHT.
- HIGH PROTECTION AGAINST EMI.
- METAL CASE CAN BE CUSTOMIZED.
- LONG RECEPTION DISTANCE.

Descriptions:

The device is a miniature type infrared remote control system receiver which has been developed and designed by utilizing the most updated IC technology. The pin diode and preamplifier are assembled on a lead frame, the epoxy package is designed as an IR filter. The demodulated output signal can directly be decoded by a microprocessor.

Applications:

- Light detecting portion of remote control.
- TV.
- VCR.
- Audio equipment.
- Air conditioner.
- CATV set top box.
- Electric fan.
- Multi-media equipment.
- Optical switch.

Package Dimensions:

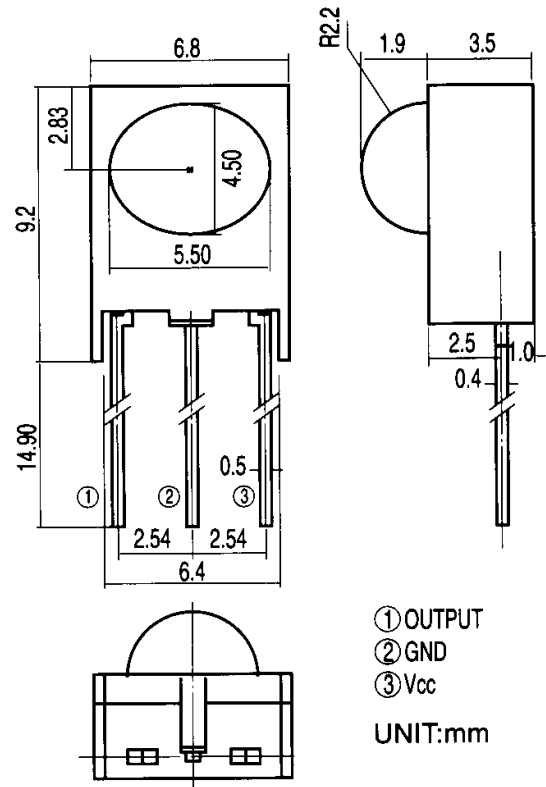

Absolute Maximum Ratings (Ta=25°C)

PARAMETER	SYMBOL	RATING	UNIT
Supply Voltage	Vcc	0 ~ 6.3	V
Operating Temperature	Topr	-30 ~ +85	°C
Storage Temperature	Tstg	-40 ~ +85	°C
Soldering Temperature *	Tsol	260	°C

* 4mm from body, < 5 sec

Electro-Optical Characteristics (Ta=25°C)

PARAMETER	SYMBOL	MIN.	TYP.	MAX.	UNIT	CONDITION
Supply Voltage	Vcc	4.5	5	5.5	V	DC Voltage
Supply Current	Icc	-	-	3	mA	No Signal Input
B.P.F Center Frequency	fo	-	38	-	KHz	-
Peak Wavelength	λ_p	-	940	-	nm	-
Reception Distance	d	8	-	-	m	At The Ray Axis *1
		4	-	-		
Half Angle (Horizontal)	θ_h	-	45	-	deg	-
Half Angle (Vertical)	θ_v	-	35	-	deg	-
High Level Pulse Width	TH	400	-	800	μs	*2
Low Level Pulse Width	TL	400	-	800	μs	
High Level Output Voltage	VH	4.5	-	-	V	30cm Over The Ray Axis
Low Level Output Voltage	VL	-	0.2	0.5	V	

* 1: The ray receiving surface at a vertex and relation to the ray axis in the range of $\theta=0^\circ$ and 45° .

* 2: A range from 30 cm to the arrival distance. Average value of 50 pulses.

NOTE:

The specified electro-optical characteristics is satisfied under the following conditions at the controllable distance.

1. Measurement place

A place that is nothing of extreme light reflect in the room.

2. External light

Project the light of ordinary white fluorescent lamps which are not high frequency lamps, they must be less than 10 Lux at the module surface. ($E_e \leq 10\text{Lux}$)

3. Standard transmitter

A transmitter whose output is so adjusted as to $V_o=400\text{mVp-p}$ and the output waveform shown in Fig.-1.

According to the measuring method shown in Fig.-2. the standard transmitter is specified.

However, the infrared photodiode to be used for the transmitter should be $\lambda_p=940\text{nm}$, $\Delta\lambda=50\text{nm}$. The photodiode used is PD438B ($V_r=5\text{V}$). (Standard light/Light source temperature 2856°K).

The carrier frequency differs depending on the items and details shown in table-1.

4. Measuring system

According to the measuring system shown in Fig.-3

Fig.-1 Transmitter Output

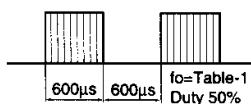

D.U.T. Output Pulse

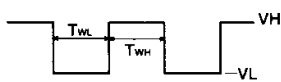

Block Diagram:

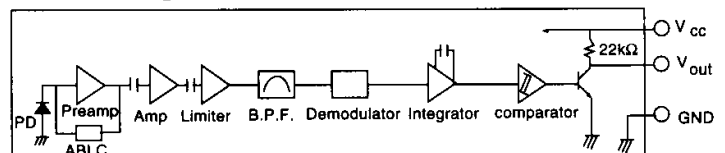

Fig.-2 Measuring Method

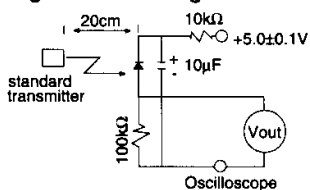
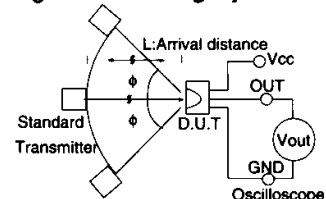

Fig.-3 Measuring System



Application Circuit:

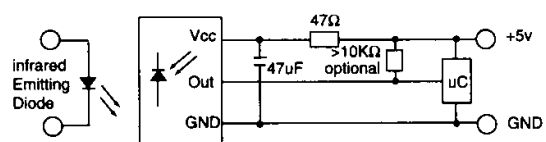

Fig-1 RELATIVE SPECTRAL SENSITIVITY VS. WAVELENGTH

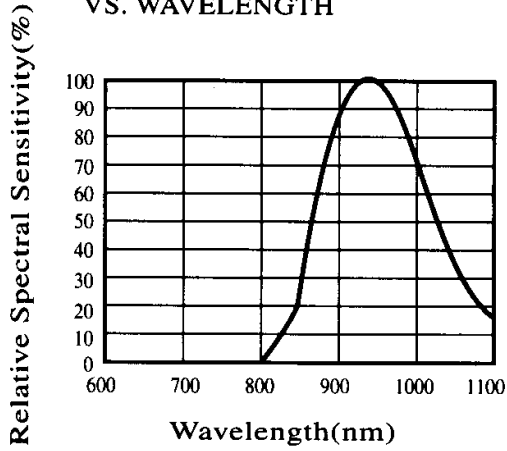

Fig-2 RELATIVE TRANSMISSION DISTANCE VS. DIRECTION

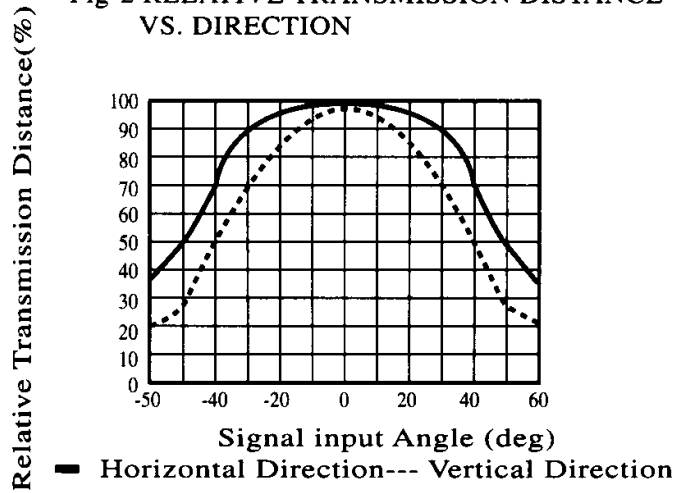

Fig-3 OUTPUT PULSE LENGTH VS. ARRIVAL DISTANCE

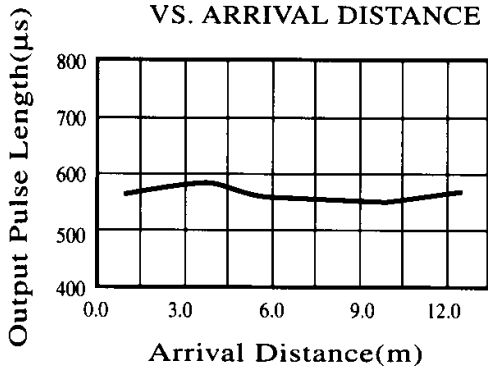

Fig-4 ARRIVAL DISTANCE VS. SUPPLY VOLTAGE

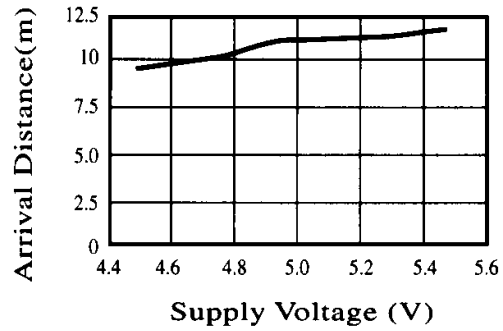

Fig-5 RELATIVE TRANSMISSION DISTANCE VS. CENTER CARRIER FREQUENCY

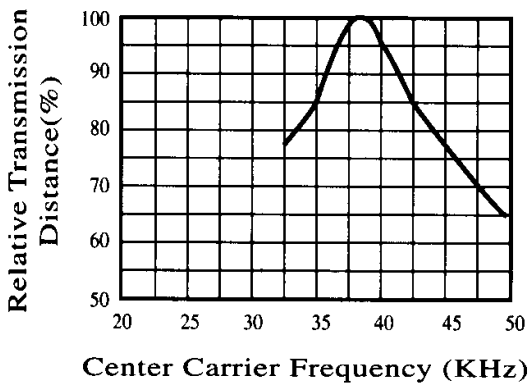
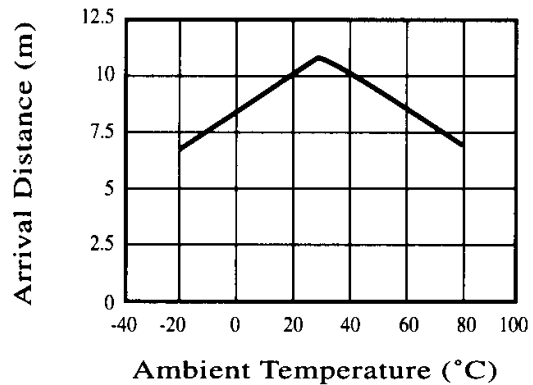

Fig-6 ARRIVAL DISTANCE VS. AMBIENT TEMPERATURE





ISO9001 QS9000
APPROVED

Reliability Test Item and Condition

NO	ITEM	TEST CONDITION	DEVICE HOURS/CYCLE	SAMPLE SIZE	AC/RE
1	Solder Heat	TEMP.:260°C±5°C	5 SEC	22PCS/each	0/1
2	Temperature Cycling	H: +85°C 30MIN. +25°C↓ 5MIN. L:-40°C 30MIN.	50 CYCLE	22PCS/each	0/1
3	Thermal Shock	H:+85°C 5MIN. ↓ 10SEC L:-10°C 5MIN	50 CYCLE	22PCS/each	0/1
4	High Temperature Storage	TEMP:85°C	1000 HRS	22PCS/each	0/1
5	Low Temperature Storage	TEMP:-40°C	1000 HRS	22PCS/each	0/1
6	DC Operating Life	Vcc=5V	1000 HRS	22PCS/each	0/1
7	High Temperature/ High Humidity	TA:85°C RH:85%	1000 HRS	22PCS/each	0/1

Inspection standard

Among electrical characteristics, total numbers shall be inspected on items blow.

@ Front distance between emitter & detector.

@ Supply current.

@ H level output voltage.

@ L level output voltage.

Items except above mentioned are not inspected particularly, but shall fully satisfy the standard value.

	CRITICAL DEFECT(CR)	MAJOR DEFECT(MA)	MINOR DEFECT(MI)
AQL	0.1	0.65	1.5