

Ultra-Low $V_{CE(sat)}$ IGBT

IXGH 60N60
IXGK 60N60
IXGT 60N60

$V_{CES} = 600\text{ V}$
 $I_{C25} = 75\text{ A}$
 $V_{CE(sat)} = 1.7\text{ V}$

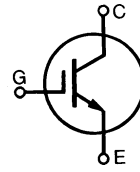

Symbol	Test Conditions	Maximum Ratings	
V_{CES}	$T_J = 25^\circ\text{C}$ to 150°C	600	V
V_{CGR}	$T_J = 25^\circ\text{C}$ to 150°C ; $R_{GE} = 1\text{ M}\Omega$	600	V
V_{GES}	Continuous	± 20	V
V_{GEM}	Transient	± 30	V
I_{C25}	$T_C = 25^\circ\text{C}$, limited by leads	75	A
I_{C90}	$T_C = 90^\circ\text{C}$	60	A
I_{CM}	$T_C = 25^\circ\text{C}$, 1 ms	200	A
SSOA (RBSOA)	$V_{GE} = 15\text{ V}$, $T_{VJ} = 125^\circ\text{C}$, $R_G = 10\ \Omega$ Clamped inductive load, $L = 30\ \mu\text{H}$	$I_{CM} = 100$ @ $0.8\ V_{CES}$	A
P_C	$T_C = 25^\circ\text{C}$	300	W
T_J		-55 ... +150	$^\circ\text{C}$
T_{JM}		150	$^\circ\text{C}$
T_{stg}		-55 ... +150	$^\circ\text{C}$
M_d	Mounting torque (M3)	1.13/10	Nm/lb.in.
	Maximum lead temperature for soldering 1.6 mm (0.062 in.) from case for 10 s	300	$^\circ\text{C}$
Weight	TO-247	6	g
	TO-264	10	g
	TO-268	4	g

TO-247 AD (IXGH)

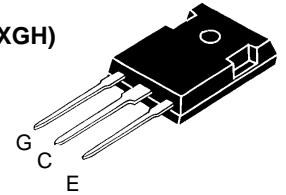

TO-268 (IXGT)

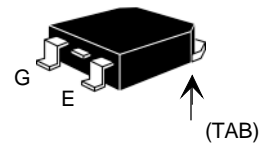

TO-264 (IXGK)

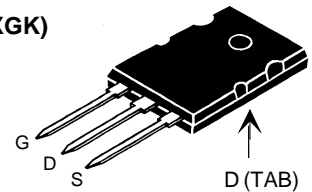

G = Gate, C = Collector,
E = Emitter, TAB = Collector

Features

- International standard package JEDEC TO-247 AD, TO-264, TO-268
- New generation HDMOS™ process
- Low $V_{CE(sat)}$ for minimum on-state conduction losses
- High current handling capability
- MOS Gate turn-on drive simplicity

Applications

- AC motor speed control
- DC servo and robot drives
- DC choppers
- Uninterruptible power supplies (UPS)
- Switch-mode and resonant-mode power supplies

Advantages

- Easy to mount with 1 screw (isolated mounting screw hole)
- Low losses, high efficiency
- High power density
- High power, surface mount package

Symbol	Test Conditions	Characteristic Values ($T_J = 25^\circ\text{C}$, unless otherwise specified)		
		min.	typ.	max.
BV_{CES}	$I_C = 250\ \mu\text{A}$, $V_{GE} = 0\text{ V}$	600		V
$V_{GE(th)}$	$I_C = 250\ \mu\text{A}$, $V_{CE} = V_{GE}$	2.5		V
I_{CES}	$V_{CE} = 0.8 \cdot V_{CES}$, $V_{GE} = 0\text{ V}$ $T_J = 25^\circ\text{C}$ $T_J = 125^\circ\text{C}$			200 μA 1 mA
I_{GES}	$V_{CE} = 0\text{ V}$, $V_{GE} = \pm 20\text{ V}$			$\pm 100\text{ nA}$
$V_{CE(sat)}$	$I_C = I_{C90}$, $V_{GE} = 15\text{ V}$			1.7 V

Symbol	Test Conditions	Characteristic Values ($T_J = 25^\circ\text{C}$, unless otherwise specified)			
		min.	typ.	max.	
g_{fs}	$I_C = I_{C90}$; $V_{CE} = 10\text{ V}$, Pulse test, $t \leq 300\ \mu\text{s}$, duty cycle $\leq 2\%$	30	55	S	
C_{ies}	$V_{CE} = 25\text{ V}$, $V_{GE} = 0\text{ V}$, $f = 1\text{ MHz}$		3700	pF	
C_{oes}			290	pF	
C_{res}			86	pF	
Q_g	$I_C = I_{C90}$, $V_{GE} = 15\text{ V}$, $V_{CE} = 0.5 V_{CES}$		130	nC	
Q_{ge}			30	nC	
Q_{gc}			45	nC	
$t_{d(on)}$	Inductive load, $T_J = 25^\circ\text{C}$ $I_C = I_{C90}$, $V_{GE} = 15\text{ V}$, $L = 100\ \mu\text{H}$, $V_{CE} = 0.8 V_{CES}$, $R_G = R_{off} = 2.7\ \Omega$ Remarks: Switching times may increase for V_{CE} (Clamp) $> 0.8 \cdot V_{CES}$, higher T_J or increased R_G		50	ns	
t_{ri}			25	ns	
$t_{d(off)}$			300	600	ns
t_{fi}			360	570	ns
E_{off}			8	15	mJ
$t_{d(on)}$	Inductive load, $T_J = 125^\circ\text{C}$ $I_C = I_{C90}$, $V_{GE} = 15\text{ V}$, $L = 100\ \mu\text{H}$ $V_{CE} = 0.8 V_{CES}$, $R_G = R_{off} = 2.7\ \Omega$ Remarks: Switching times may increase for V_{CE} (Clamp) $> 0.8 \cdot V_{CES}$, higher T_J or increased R_G		50	ns	
t_{ri}			25	ns	
E_{on}			3	mJ	
$t_{d(off)}$			650	ns	
t_{fi}			550	ns	
E_{off}		17	mJ		
R_{thJC}			0.42	K/W	
R_{thCK}	(IXGH)	0.25		K/W	
	(IXGK)	0.15		K/W	

TO-247 AD (IXFH) Outline

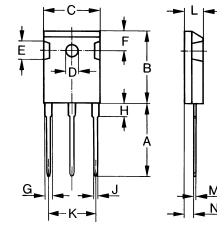

Dim.	Millimeter		Inches	
	Min.	Max.	Min.	Max.
A	19.81	20.32	0.780	0.800
B	20.80	21.46	0.819	0.845
C	15.75	16.26	0.610	0.640
D	3.55	3.65	0.140	0.144
E	4.32	5.49	0.170	0.216
F	5.4	6.2	0.212	0.244
G	1.65	2.13	0.065	0.084
H	-	4.5	-	0.177
J	1.0	1.4	0.040	0.055
K	10.8	11.0	0.426	0.433
L	4.7	5.3	0.185	0.209
M	0.4	0.8	0.016	0.031
N	1.5	2.49	0.087	0.102

TO-264 AA (IXFK) Outline

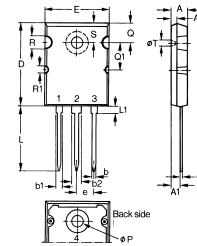

Dim.	Millimeter		Inches	
	Min.	Max.	Min.	Max.
A	4.82	5.13	.190	.202
A1	2.54	2.89	.100	.114
A2	2.00	2.10	.079	.083
b1	1.12	1.42	.044	.056
b2	2.39	2.69	.094	.106
b2	2.90	3.09	.114	.122
c	0.53	0.83	.021	.033
D	25.91	26.16	1.020	1.030
E	19.81	19.96	.780	.786
e	5.46 BSC		.215 BSC	
J	0.00	0.25	.000	.010
K	0.00	0.25	.000	.010
L	20.32	20.83	.800	.820
L1	2.29	2.59	.090	.102
P	3.17	3.66	.125	.144
Q	6.07	6.27	.239	.247
Q1	8.38	8.69	.330	.342
R	3.81	4.32	.150	.170
R1	1.78	2.29	.070	.090
S	6.04	6.30	.238	.248
T	1.57	1.83	.062	.072

TO-268AA (IXFT) (D³ PAK)

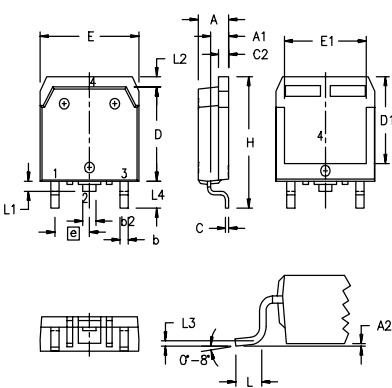

Dim.	Millimeter		Inches	
	Min.	Max.	Min.	Max.
A	4.9	5.1	.193	.201
A ₁	2.7	2.9	.106	.114
A ₂	.02	.25	.001	.010
b	1.15	1.45	.045	.057
b ₂	1.9	2.1	.75	.83
C	.4	.65	.016	.026
D	13.80	14.00	.543	.551
E	15.85	16.05	.624	.632
E ₁	13.3	13.6	.524	.535
e	5.45 BSC		.215 BSC	
H	18.70	19.10	.736	.752
L	2.40	2.70	.094	.106
L1	1.20	1.40	.047	.055
L2	1.00	1.15	.039	.045
L3	0.25 BSC		.010 BSC	
L4	3.80	4.10	.150	.161

Min. Recommended Footprint

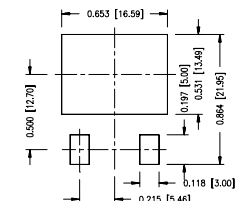

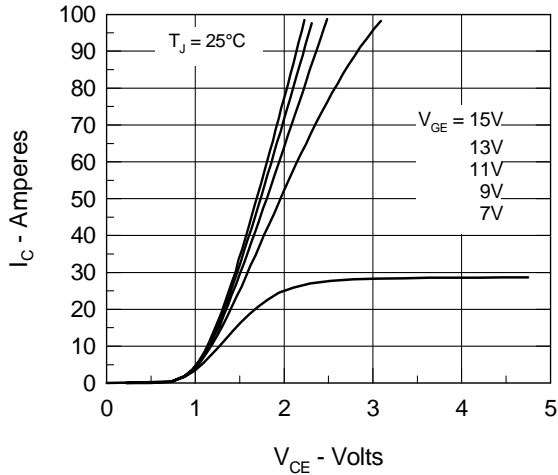

Fig. 1. Saturation Voltage Characteristics

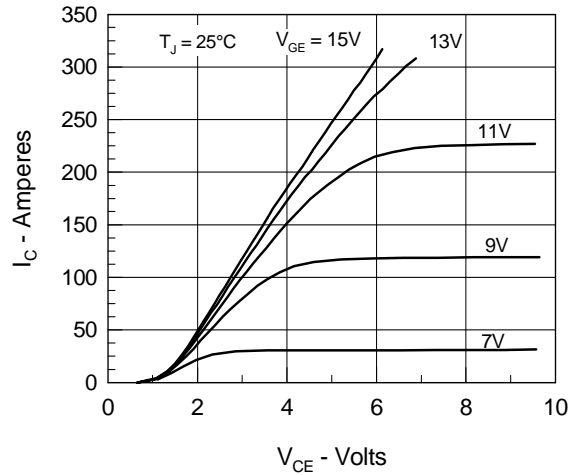

Fig. 2. Extended Output Characteristics

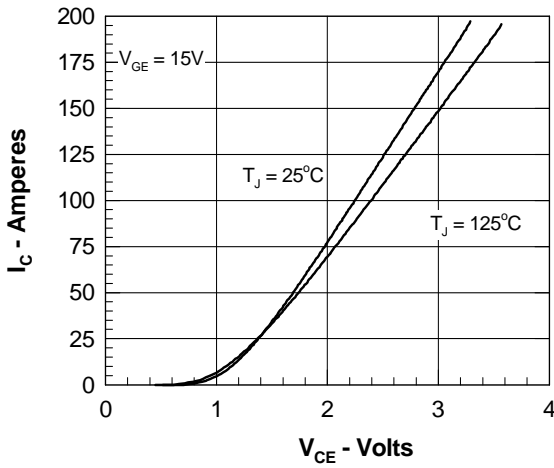

Fig. 3. Saturation Voltage Characteristics

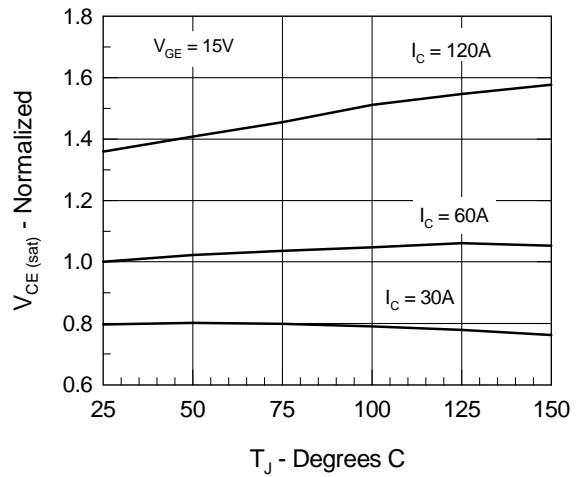

Fig. 4. Temperature Dependence of $V_{CE(sat)}$

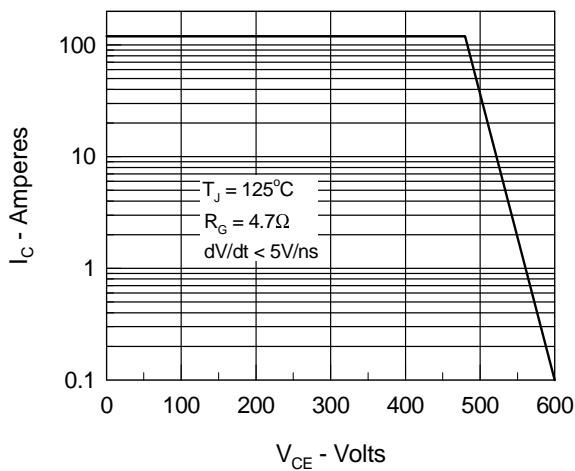

Fig. 5. Turn-off Safe Operating Area

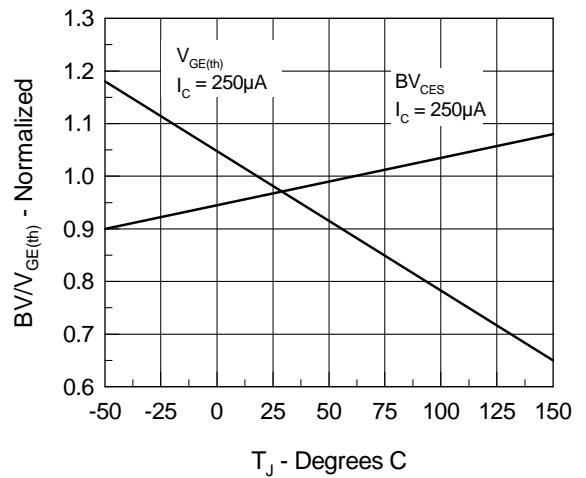

Fig. 6. Temperature Dependence of BV_{CES} & $V_{GE(th)}$

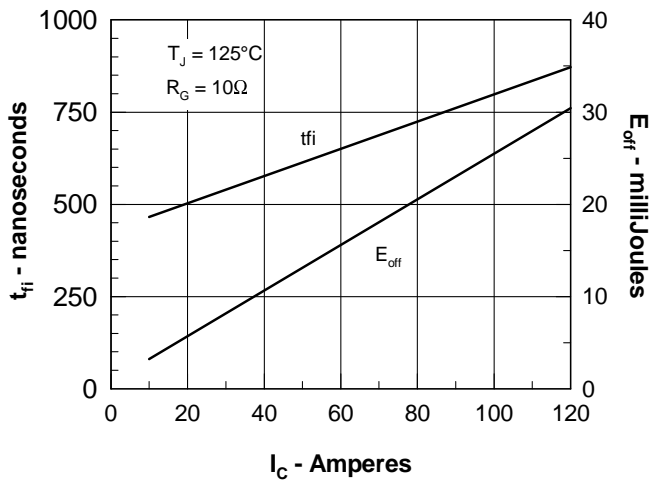

Fig. 7. Dependence of t_{fi} and E_{OFF} on I_C.

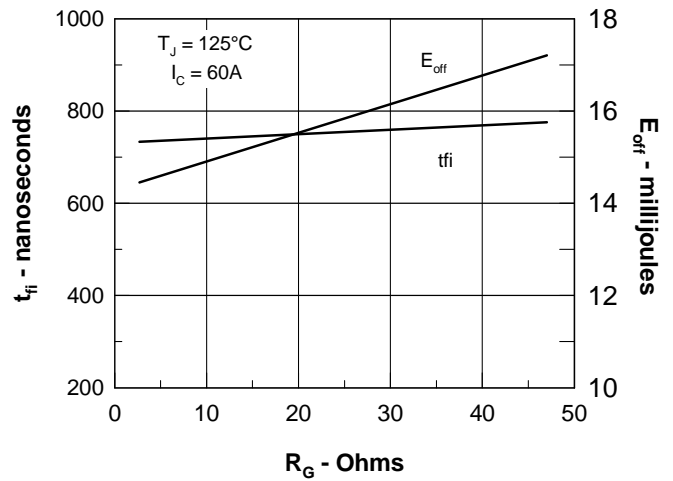

Fig. 8. Dependence of t_{fi} and E_{OFF} on R_G.

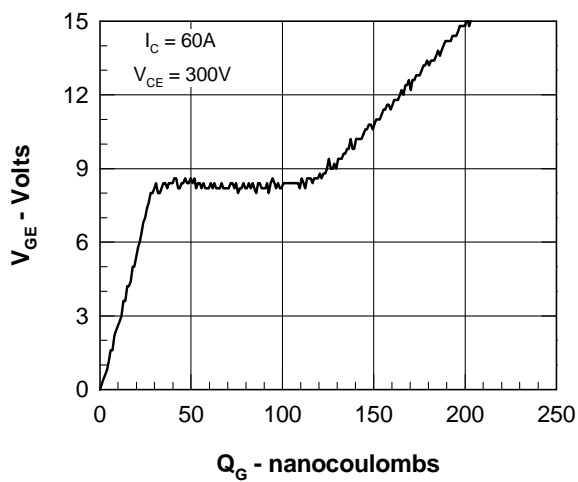

Fig. 9. Gate Charge

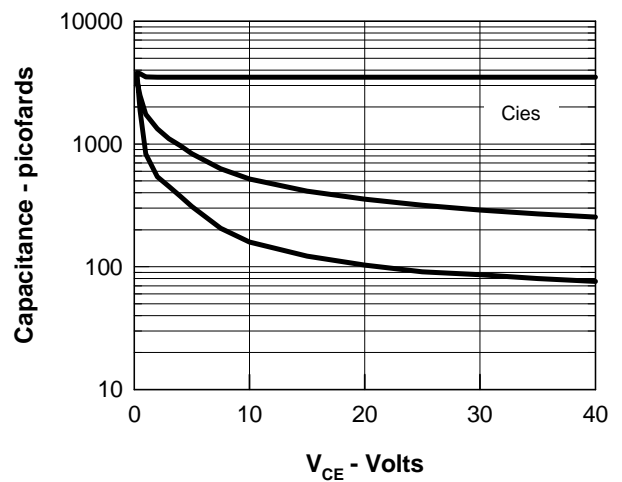

Fig. 10. Junction Capacitance Curves

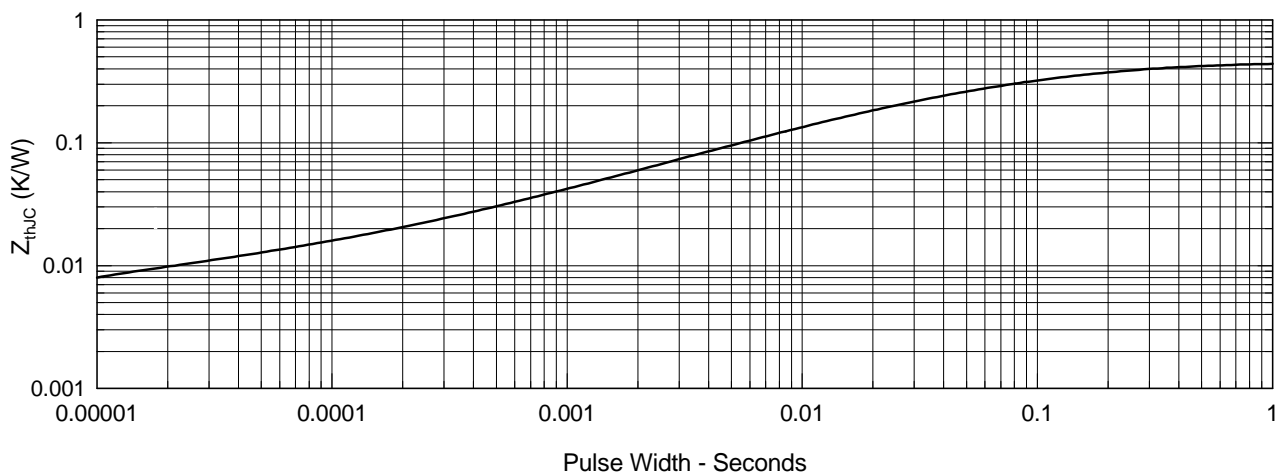

Fig. 11. Transient Thermal Resistance