

PRODUCT SPECIFICATION

DATE:05/18/2004

cosmo ELECTRONICS CORPORATION	SMD LED : KL191UYG	NO. 61L01005	REV. 1
		SHEET 1 OF 8	

Features

Package: 1.6x0.8x0.6mm(0603) standard package

Feature of the device: extremely wide viewing angle
; ideal for backlighting and coupling
in light guides

Wavelength: 570nm(Yellow Green)

Viewing angle: Extremely Wide(120°)

Grouping parameter: luminous intensity

Assembly methods: suitable for all SMT assembly methods

Soldering methods: IR reflow soldering

Taping: Package in 8mm tape on 7" diameter reel

Package Dimensions

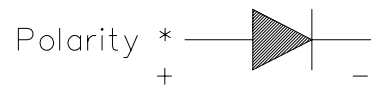
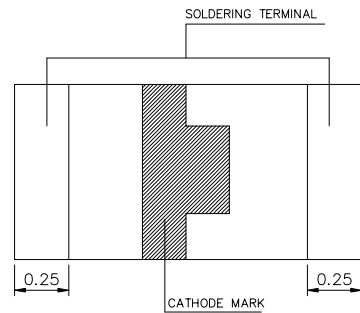
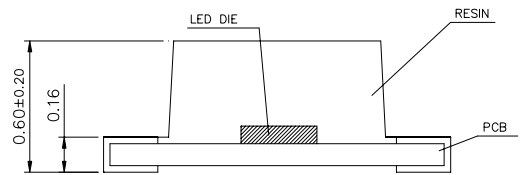
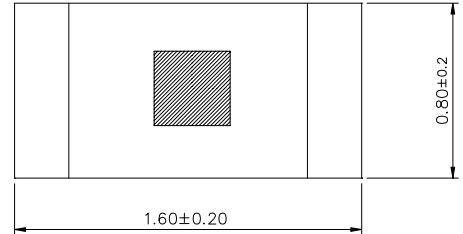

Applications

Automotive : Dashboards , stop lamps , turn signals

Backlighting : LCDs , Key pads , advertising

Status indicators : Consumer , Key pads , advertising

Absolute Maximum Ratings (Ta=25°C)

Parameter	Symbol	Spec	Unit
Reverse Voltage	VR	5	V
Forward Current	IF	30	mA
Operating Temperature	Top	-25~+80	°C
Storage Temperature	Tstg	-30~+85	°C
Power Dissipation	Pd	78	mW
Peak Forward Current (Duty ≤ 1/10, t ≤ 0.1msec)	IFp	100	mA

For reflow soldering

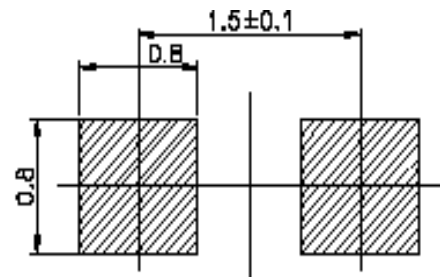

Notes: Tolerances Unless Dimension ±0.1mm, Angle ±0.5°, Unit=mm

PRODUCT SPECIFICATION

DATE:05/18/2004

cosmo ELECTRONICS CORPORATION	SMD LED : KL191UYG	NO. 61L01005	REV. 1
		SHEET 2 OF 8	

Electro-optical Characteristics at Ta=25°C

Code for parts	Lighting color	Material	Electro-optical Data (20mA)				Wavelength (nm) typ			Reverse Current IR(uA)@VR=5V
			Vf		Iv		λ d	λ p	Δ λ	
			Typ.	Max	Min	Typ.				
KL-191UYG	Ultra bright yellow green	AllnGaP	2.2	2.5	25	50	570	574	20	100

The Reliability criteria of SMD LED

Item	Symbol	Test Condition	Limit	
			Min	Max
Forward Voltage	VF	IF=10mA	–	U.S.L*1.2
Reverse Current	IR	VR=5V	–	U.S.L*2.0
Power	PO	IF=10mA	L.S.L*0.7	–

*U.S.L: Upper Standard Level

*L.S.L: Lower Standard Level

Results of Reliability Test

NO	Item	Test Condition	TestHours/ Cycles	Sample NO	Ac / Re
1	Temperature Cycle	H:+100°C 30min ∩ 5min L: -40°C 30min	100CYCES	11 PCS	0 / 1
2	High Temperature Storage	Temp : 100°C	500HRS	11 PCS	0 / 1
3	Low Temperature Storage	Temp : -40°C	500HRS	11 PCS	0 / 1
4	DC Operating Life	IF: 20mA	500HRS	11 PCS	0 / 1
5	High Temperature / High Humidity	60°C / 90% RH	500HRS	11 PCS	0 / 1

PRODUCT SPECIFICATION

DATE:05/18/2004

cosmo ELECTRONICS CORPORATION	SMD LED : KL191UYG	NO. 61L01005	REV. 1
		SHEET 3 OF 8	

Typical Electro-Optical Characteristics Curves

Relative spektrale Emission $I_{rel}=f(\lambda)$, $T_a=25^\circ\text{C}$, $I_F=10\text{mA}$

$V(\lambda)$ =Standard eye response curve

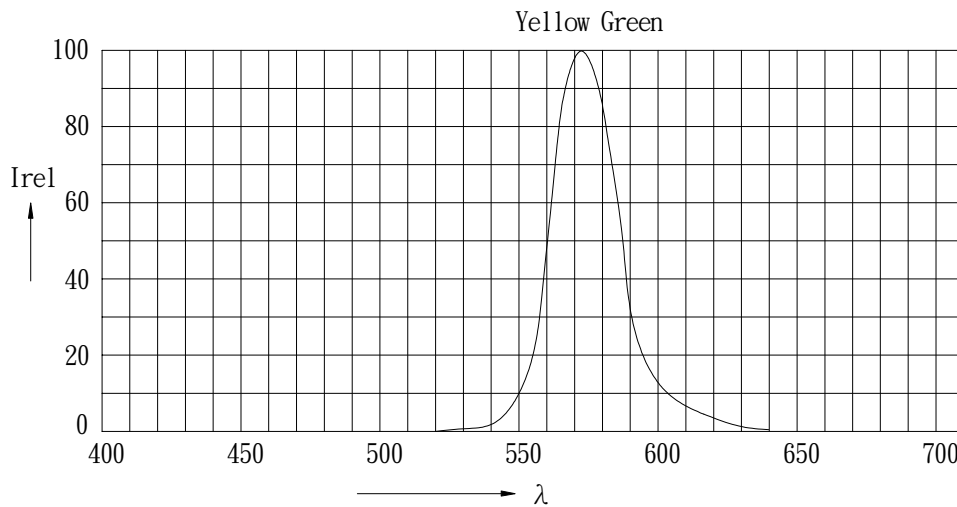

Forward Current $I_F=f(V_F)$, $T_A=25^\circ\text{C}$

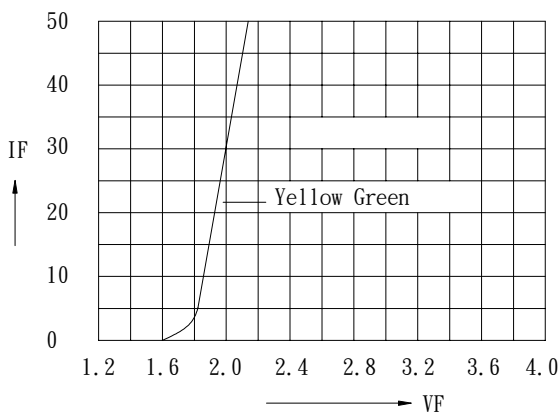

Relative Luminous Intensity $I_v/I_v(10\text{mA})=f(I_F)$
 $T_A=25^\circ\text{C}$

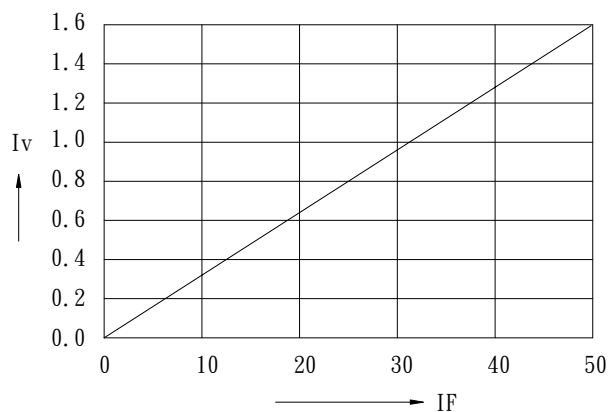

PRODUCT SPECIFICATION

DATE:05/18/2004

cosmo ELECTRONICS CORPORATION	SMD LED : KL191UYG	NO. 61L01005	REV. 1
		SHEET 4 OF 8	

Max. Permissible Forward Current $I_F=f(T_a)$

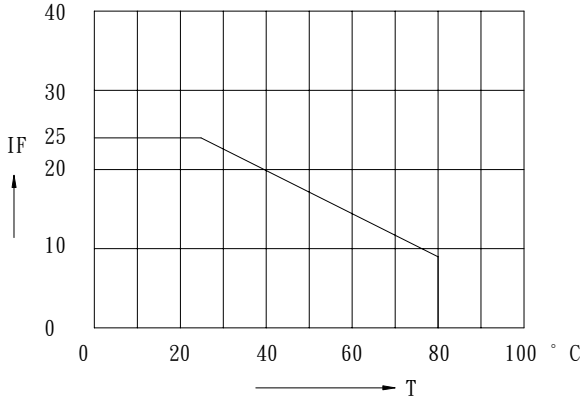

Radiation Characteristic $I_{rel}=f(\phi)$

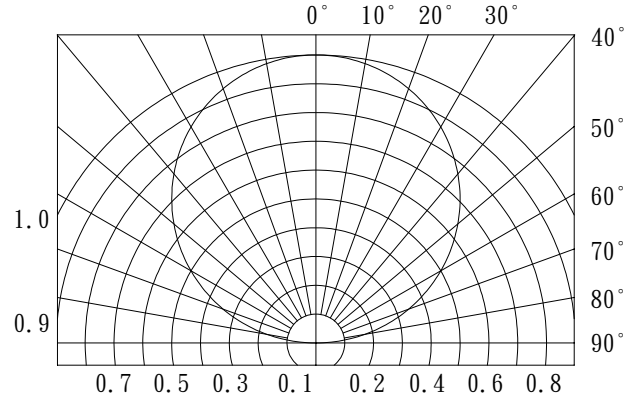

Method of Taping / Polarity and Orientation

Packing unit 3000/reel

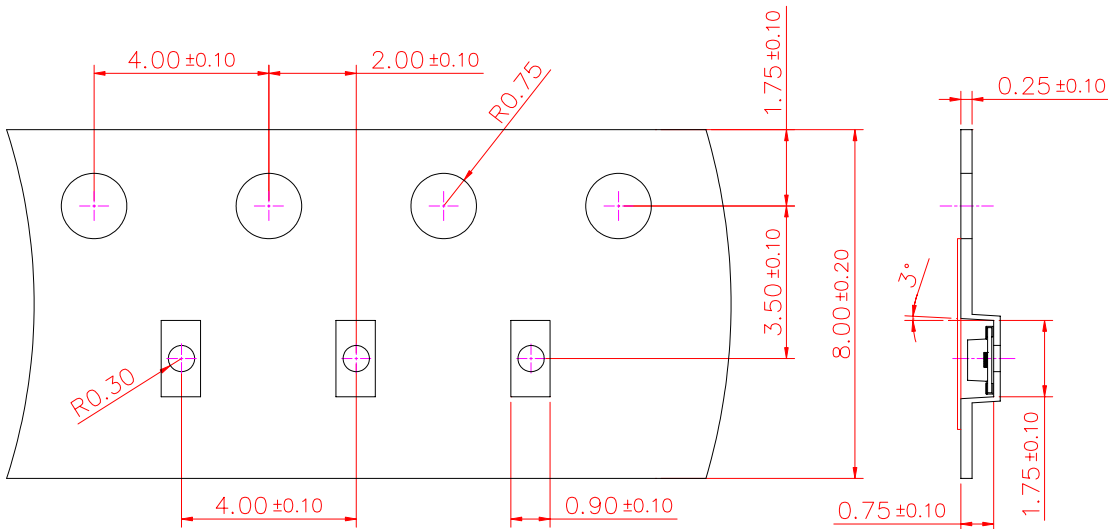

Unit : mm

Direction

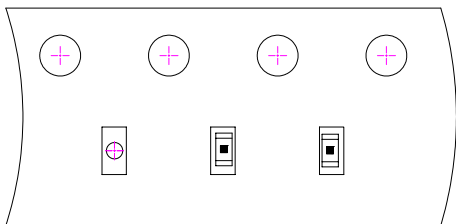

U: Taping upward

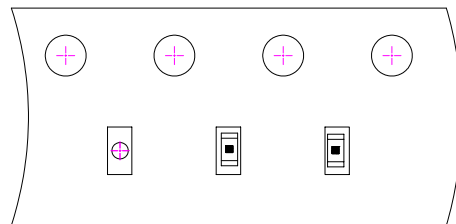

D: Taping downward

Notes: All dimensions are in millimeters (inches)

PRODUCT SPECIFICATION

DATE:05/18/2004

cosmo ELECTRONICS ORPORATION	SMD LED : KL191UYG	NO. 61L01005	REV. 1
		SHEET 5 OF 8	

Package Dimensions of Reel

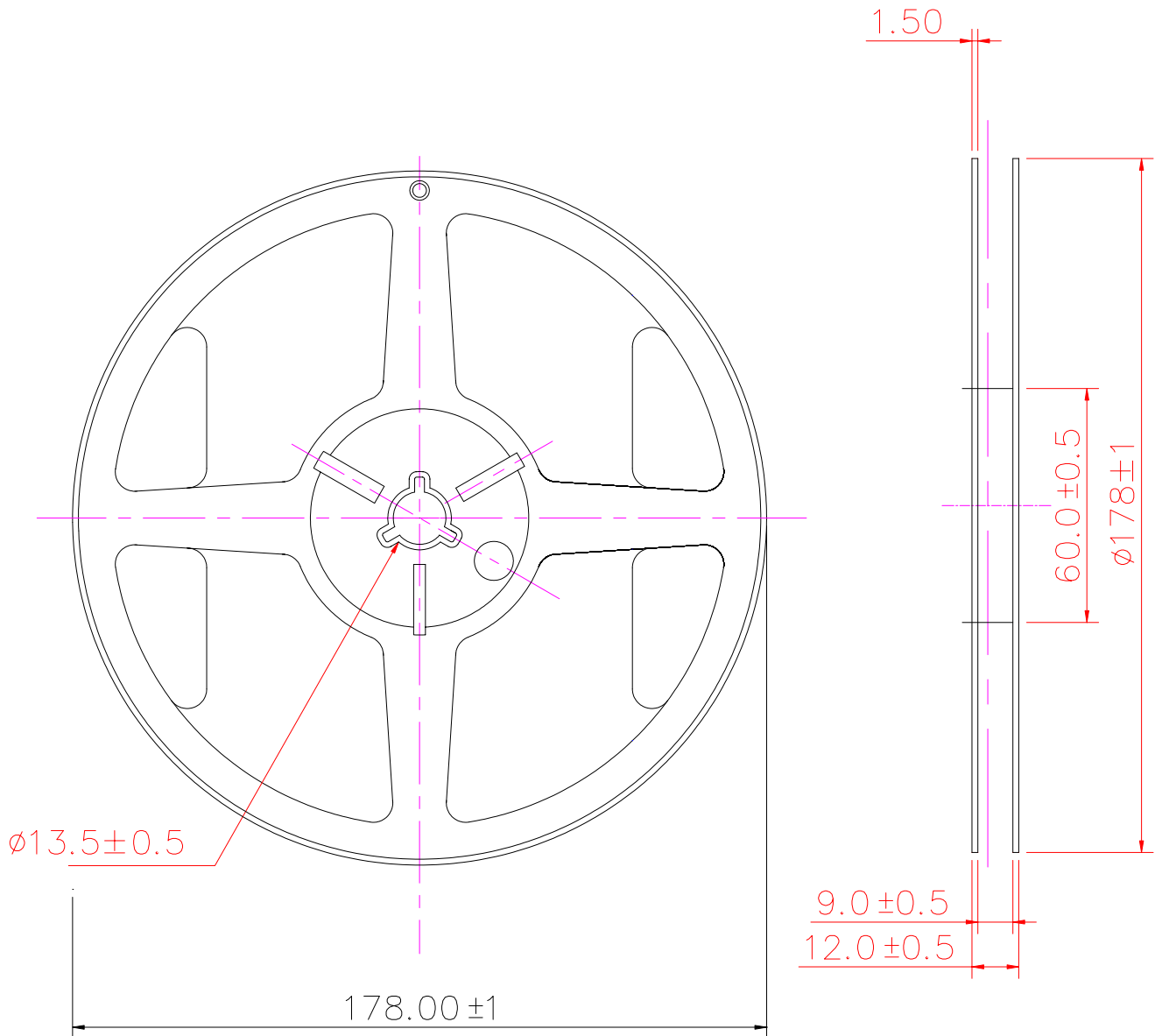

Unit: mm

PRODUCT SPECIFICATION

DATE:05/18/2004

cosmo ELECTRONICS CORPORATION	SMD LED : KL191UYG	NO. 61L01005	REV. 1
		SHEET 6 OF 8	

Packaging

Product lable

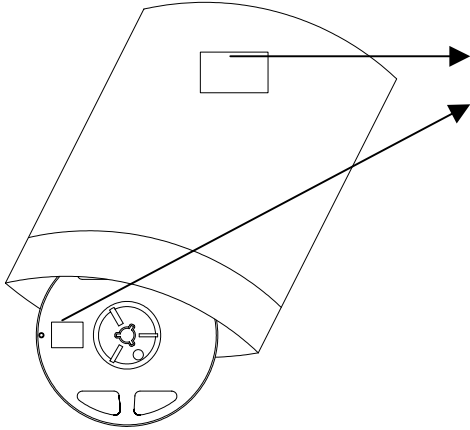

CUSTOMER:
CUSTOMER P/N:
DEVICE TYPE:
BIN:
COLOR RANK:
LOT NO:
QTY:

CAUTION: After open the aluminum laminate bag the lamps should be storage in the Follow condition

Temperautre:5 to 30 °C ,Humidity:70%,Storage time:72hrs max

Backing condition :If backing is necessary , we recommended the backing condition is 60 +/- 5°C 10hours

Packing

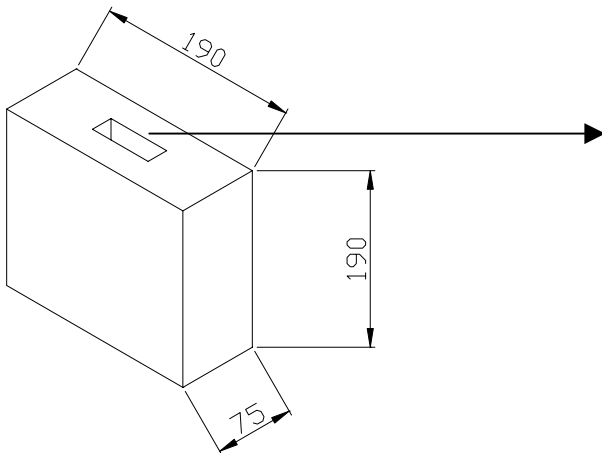

CUSTOMER:
CUSTOMER P/N:
DEVICE TYPE:
BIN:
COLOR RANK:
LOT NO:
QTY:

PRODUCT SPECIFICATION

DATE:05/18/2004

cosmo ELECTRONICS CORPORATION	SMD LED : KL191UYG	NO. 61L01005	REV. 1
		SHEET 7 OF 8	

Cautions for use

Over-current-proof

Customer must apply resistors for protection ,others slight voltage shit will cause big current change (Burn out will happen).

Storage time

The operation of temperature and RH are : $5^{\circ}\text{C}\sim 35^{\circ}\text{C}$,RH60%.

Once the package is opened , the products should be used within a week.

Otherwise , they should be kept in a damp proof box with descanting agent.

Considering the tape life , we suggest our customers to use our products within a year(from production date) If opened more than one week in an atmosphere $5^{\circ}\text{C}\sim 35^{\circ}\text{C}$, RH60% , they should be treated at $60^{\circ}\text{C} \pm 5^{\circ}\text{C}$ for 15 hrs.

COSMO-Innotek will not be held responsible for any damage to the user that may result from accidents or any other reasons during operation of the user's unit if use to exceed the absolute maximum ratings, or not keep the matters that demand special attention.

Others

Soldering Heat Reliability

Available for Pb free soldering process

Please refer to the following figure :

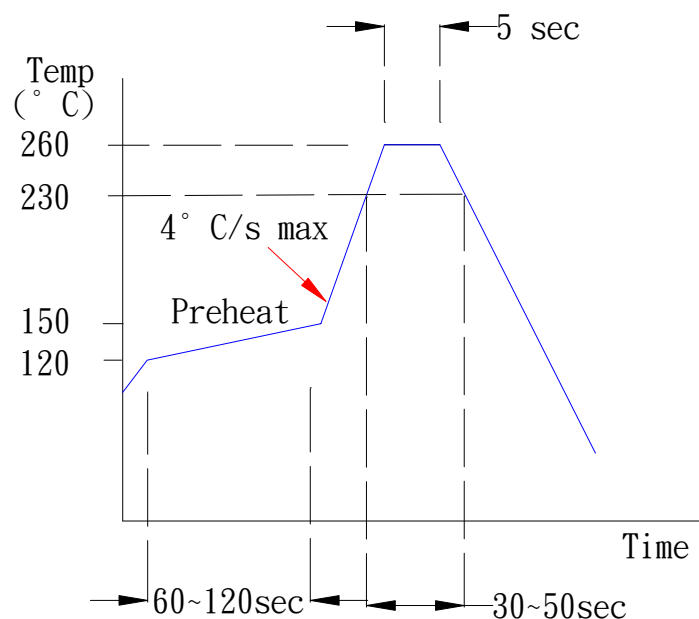

PRODUCT SPECIFICATION

DATE:05/18/2004

cosmo ELECTRONICS CORPORATION	SMD LED : KL191UYG	NO. 61L01005	REV.
		SHEET 8 OF 8	1

Soldering Iron

Basic spec is ≤ 5 sec when 260°C . If temperature is higher, time shorter ($+10^{\circ}\text{C} \rightarrow -1$ sec).
Power dissipation of Iron should be smaller than 15W, and temperature should be controllable.
Surface temperature of the device should be under 230°C .

Rework

Customer must finish rework within 5sec under 245°C .
The head of Iron can not touch copper foil.
Twin-head type is preferred.

