

## VARIABLE CAPACITANCE DIODE

### FEATURES

- Very Small URD Surface Mount Package
- Very Low Operating Voltage (1 to 8 V)
- Large Capacitance Ratio (A = 7.0 minimum)
- Excellent Linearity (CV Curve)
- Very Small Capacitance Deviation at Tape/Reel

### APPLICATIONS

- Communications Equipment
- Multi-Channel Cordless Telephone
- Voltage Controlled Oscillator
- UHF Wireless Communication Systems

### DESCRIPTION

The KV1811E is a variable capacitance diode designed for UHF applications.

The KV1811E is available in a very small URD Surface Mount Package.

### CLASSIFICATION

(Unit: pF)

C		RANK				
		3	4	5	6	7
C <sub>1</sub>	MIN	19.51	20.22	21.03	21.83	22.64
	MAX	20.42	21.23	22.03	22.84	23.55

Note: Rank is determined after testing and marked on the reel. All the diodes on a reel have the same rank, but rank can not be specified when ordering.

### ORDERING INFORMATION

KV1811E  Tape/Reel Code

TAPE/REEL CODE  
TR: Tape Right

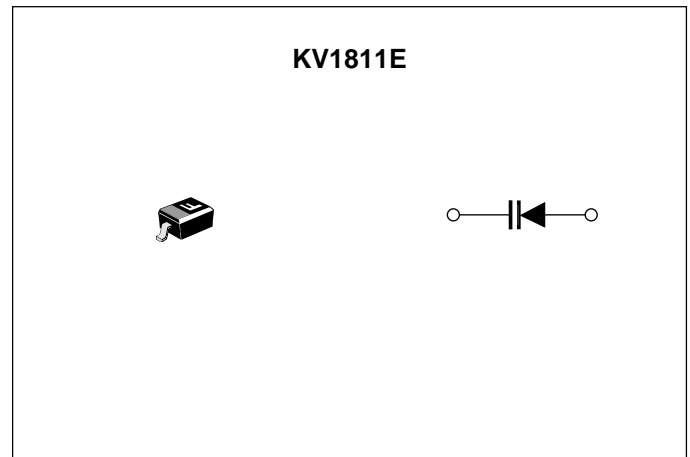

# KV1811E

---

## ABSOLUTE MAXIMUM RATINGS

Reverse Voltage ..... 25 V  
Forward Current ..... 10 mA  
Power Dissipation ..... 50 mW

Storage Temperature Range ..... -55 to +150 °C  
Operating Temperature Range ..... -55 to +85 °C

## ELECTRICAL CHARACTERISTICS

Test conditions:  $T_A = 25\text{ °C}$

SYMBOL	PARAMETER	TEST CONDITIONS	MIN	TYP	MAX	UNITS
$V_{REV}$	Reverse Voltage	$I_{REV} = 10\ \mu\text{A}$	20			V
$I_{REV}$	Reverse Current	$V_{REV} = 16\ \text{V}$			5.0	nA
$C_1$	Diode Capacitance 1	$V_{REV} = 1\ \text{V}, f = 1\ \text{MHz}$	19.51	21.50	23.55	pF
$C_8$	Diode Capacitance 8	$V_{REV} = 8\ \text{V}, f = 1\ \text{MHz}$	2.14	2.50	2.92	pF
$R_S$	Series Resistance	$C = 8\ \text{pF}, f = 470\ \text{MHz}$			1.8	$\Omega$
A	Capacitance Ratio	$C_1 / C_8$	7.0			

Note 1: Diode Capacitance measured with HP 4279A or equivalent instruments (at OSC level 20 mVrms,  $\pm 5$  mVrms).

Note 2: Series Resistance measured with HP 4191A or equivalent instruments.

## TYPICAL PERFORMANCE CHARACTERISTICS

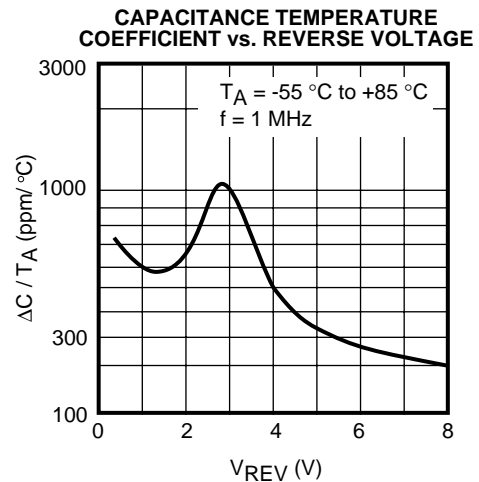
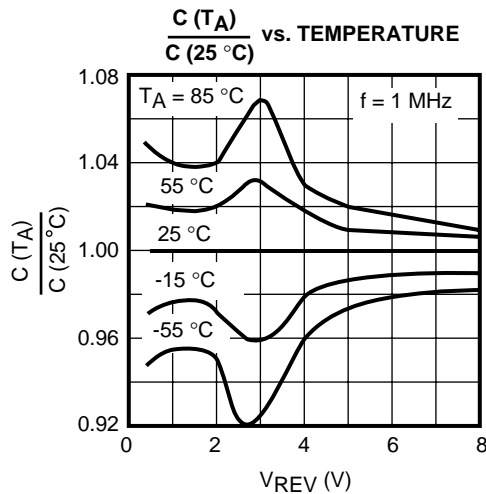
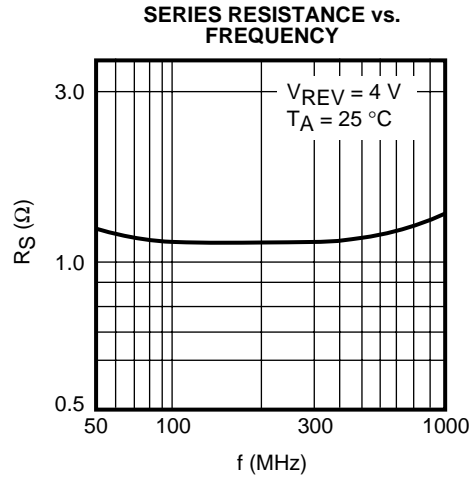
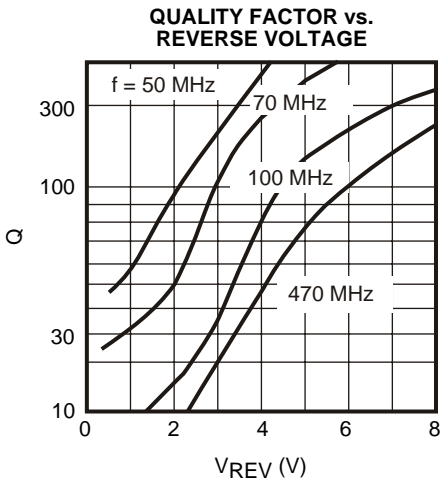
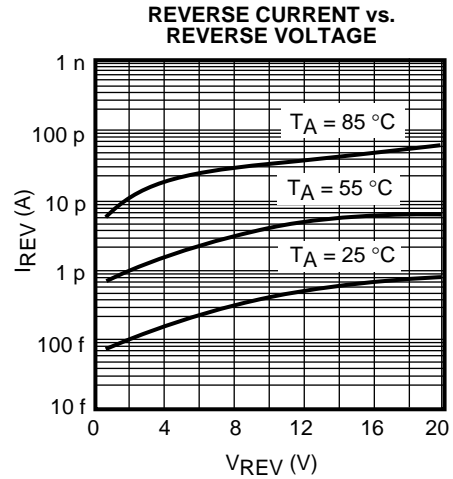
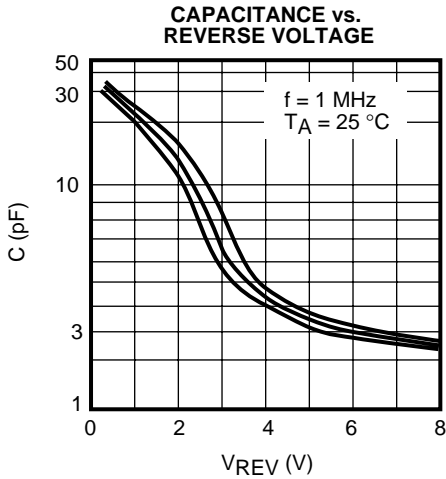

## PACKAGE OUTLINE

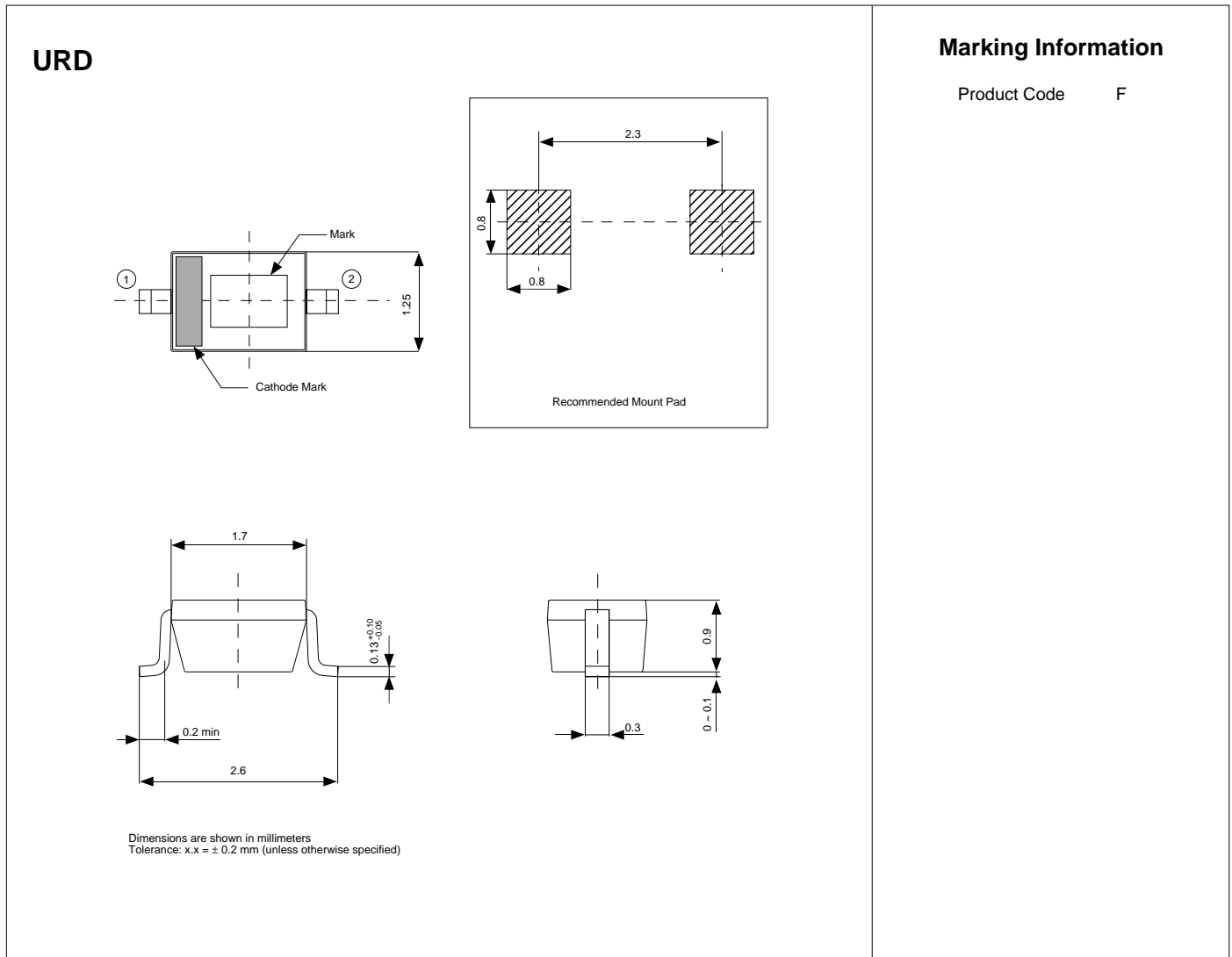

Toko America, Inc. Headquarters  
1250 Feehanville Drive, Mount Prospect, Illinois 60056  
Tel: (847) 297-0070 Fax: (847) 699-7864

### TOKO AMERICA REGIONAL OFFICES

Midwest Regional Office  
Toko America, Inc.  
1250 Feehanville Drive  
Mount Prospect, IL 60056  
Tel: (847) 297-0070  
Fax: (847) 699-7864

Western Regional Office  
Toko America, Inc.  
2480 North First Street, Suite 260  
San Jose, CA 95131  
Tel: (408) 432-8281  
Fax: (408) 943-9790

Eastern Regional Office  
Toko America, Inc.  
107 Mill Plain Road  
Danbury, CT 06811  
Tel: (203) 748-6871  
Fax: (203) 797-1223

Semiconductor Technical Support  
Toko Design Center  
4755 Forge Road  
Colorado Springs, CO 80907  
Tel: (719) 528-2200  
Fax: (719) 528-2375

Visit our Internet site at <http://www.tokoam.com>

The information furnished by TOKO, Inc. is believed to be accurate and reliable. However, TOKO reserves the right to make changes or improvements in the design, specification or manufacture of its products without further notice. TOKO does not assume any liability arising from the application or use of any product or circuit described herein, nor for any infringements of patents or other rights of third parties which may result from the use of its products. No license is granted by implication or otherwise under any patent or patent rights of TOKO, Inc.