

T-7S-07-15

LA2800N

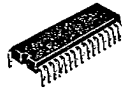

3061

Monolithic Linear IC

Telephone Answering Machine

©2572

General Description

The LA2800N is a telephone answering machine-use bipolar IC that performs the basic functions required for telephone answering machine and has the microcomputer interfaces to control these functions. The LA2800N is housed in a 30-pin DIP shrink package.

The LA2800N can be used in conjunction with the LA4070 that contains the power amp for telephone answering machine, various drivers, and a 5V regulator to make up a telephone answering machine system.

Functions

- 1) Preamp for recording/playback x 2 (with ALC)
(Recording: DC bias)
- 2) Microphone amp
- 3) Beep tone input amp
- 4) Analog switches for switchover of (1) to (3)
- 5) Voice detector
- 6) Zero-cross comparator for beep tone detection
- 7) CPC detector (CPC: Calling Party Control)
- 8) Line amp
- 9) Microcomputer interfaces

Features

- . Since the basic functions required for telephone answering machine can be controlled by using a microcomputer, a unique telephone answering machine can be made available by preparing a software program.
- . The recording amp gain and DC bias current can be set independently by an external resistor.
- . Low distortion

Maximum Ratings at Ta=25°C

Maximum Supply Voltage
 Allowable Power Dissipation
 Operating Temperature
 Storage Temperature

V_{CCmax}
 P_{dmax} $T_a \leq 70^\circ C$
 T_{opg}
 T_{stg}

unit
 15 V
 400 mW
 -20 to +70 °C
 -40 to +125 °C

Continued on next page.

Case Outline 3061-D30SIC
 (unit:mm)

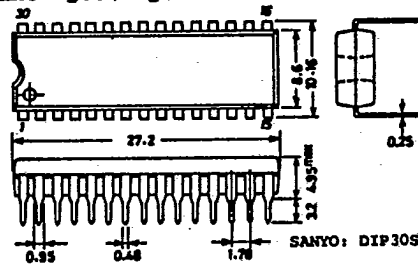

8067AT/5217KI, TS No.2572-1/9

LA2800N

7-75-07-15

Continued from preceding page.

				unit
Allowable Flow-in Current	I ₁₈		1.0	mA
Allowable Flow-in Current	I ₂₀		1.0	mA
Allowable Flow-in Current	I ₂₂		1.0	mA
Allowable Flow-in Current	I ₂₄		1.0	mA
Allowable Flow-in Current	I ₂₅		1.0	mA
Allowable Flow-in Current	I ₂₆		1.0	mA
Allowable Flow-in Current	I ₂₇		1.0	mA
Allowable Flow-in Current	I ₂₈		1.0	mA
Allowable Flow-in Current	I ₂₉		1.0	mA
Allowable Flow-in Current	I ₃₀		1.0	mA

Operating Conditions at Ta=25°C

				unit
Recommended Supply Voltage	V _{CC}		9	V
Operating Voltage Range	V _{CCOP}		7 to 12	V

Operating Characteristics at Ta=25°C, V_{CC}=9V

			min	typ	max	unit
[Preamp]	OGM REC					
Voltage Gain	V _{GC}	Closed loop -70dBs input, Input pin7, Test pin10	47	49	51	dB
Total Harmonic Distortion	THD	Input -40dBs 1kHz, Input pin7, Test pin10		0.5	1.0	%
ALC Turn Point	V _{ALC}	Input pin7, Test pin10	-58	-54	-50	dB
ALC Saturation	V _{OS}	Input -40dBs 1kHz, Input pin7, Test pin10	453	570	718	mVrms
Equivalent Input Noise Voltage	V _{NI}	Input short (2.2kohms contained) FLAT, Test pin10			50	uVrms
[REC Amp]	OGM REC					
Voltage Gain	V _{GR}	Pin1-GND, Z=50kohms, Input pin12, Test pin5	-6.8	-3.8	-0.8	dB
Output Bias Voltage		Pin1-GND, Z=100kohms, Test pin5	1.1	1.8	2.3	V
[Line Amp]	OGM OUT					
Voltage Gain	V _{GL}	Input pin12, Test pin23	8	9.3	11	dB
Maximum Output Voltage	V _{OMAX}	Input pin12, Test pin23	2.0			Vrms
[Beep Tone Detector]	OGM PLAY					
Output Signal Duty Ratio	D-R	Pin 12 input -22dBs, Input pin12, Test pin22	40	50	60	%
Output Terminal ON-State Voltage	V _{SAT}	Pin 12 GND, 5V applied through R=20kohms, Input pin12, Test pin22			0.4	V
[Voice Detector]	OGM PLAY					
Sensitivity	V _{VOICE LF}	1kHz, Pin 12 input -24dBs, Input pin12, Test pin18			0.3	V
	V _{VOICE H}	Pin12 input -28dBs, Input pin12, Test pin18	4		6	V
Output Terminal ON-State Voltage	V _{SAT}	1V applied to pin17, 5V applied to pin18 through R=20kohms Input pin17, Test pin18			0.3	V
[Output Terminal ON-State Voltage]						
Pin 20 (CPC Output) Voltage		Pin21 GND, 5V applied to pin20 through R=20kohms, Test pin 20			0.3	V
[Voltage Applied to Control Pin]						
Voltage Applied to Control pin (Pins 24 to 30)	V _H	"1"=H level, Applied through resistor	1			V
	V _L	"0"=L level			0.3	V

LA2800N

T-75-07-15

Test Circuit

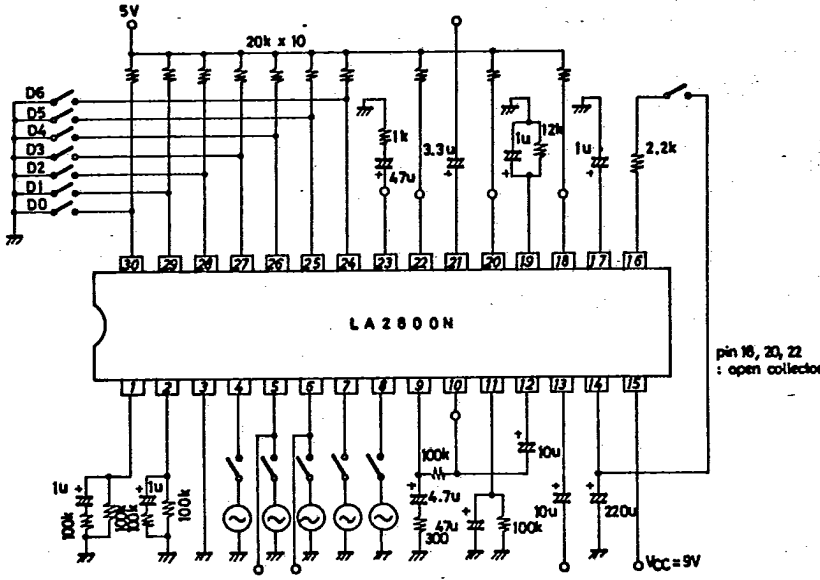

Equivalent Circuit Block Diagram

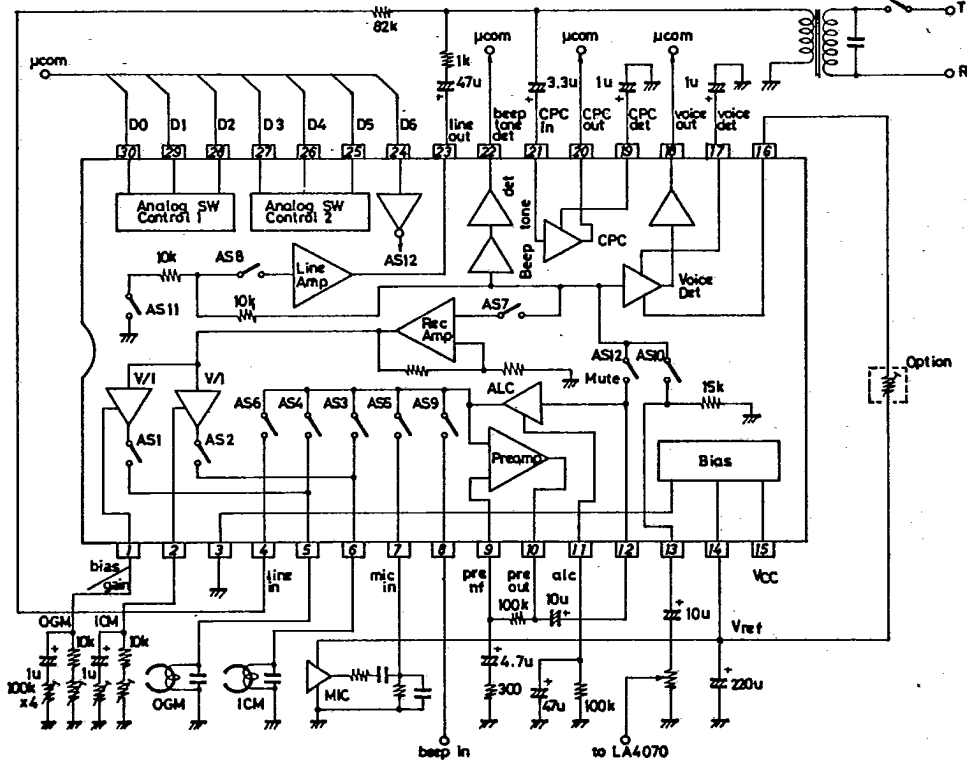

T-75-07-15

LA2800N

Mode Select (On-chip switches AS1 to AS12 are controlled by D0 to D6.)
 D0 to D6(pin30 to pin24): "1"="H"level,"D"="L"level
 AS1 to AS12:"1"=ON,"0"=OFF

D2,D1,D0 → AS1 to AS6,AS9										
MODE	D2	D1	D0	AS1	AS2	AS3	AS4	AS5	AS6	AS9
CLA	0	0	0	0	0	1	0	0	0	0
OGM REC	0	0	1	1	0	0	0	1	0	0
BEEP REC	0	1	0	1	0	0	0	0	0	1
OGM PLAY	0	1	1	0	0	0	1	0	0	0
PLAY	0	0	0	0	0	1	0	0	0	0
DICTIONATION REC	1	0	1	0	1	0	0	1	0	0
OGM OUT	0	1	1	0	0	0	1	0	0	0
ICM REC	1	1	1	0	1	0	0	0	1	0
2 WAY REC	1	1	1	0	1	0	0	0	1	0
CALL COUNTER OUT	0	1	0	1	0	0	0	0	0	1
ICM OUT	0	0	0	0	0	1	0	0	0	0
ALARM	0	1	0	1	0	0	0	0	0	1
OGM CHANGE	1	0	0	1	0	0	0	0	1	0
LINE MUTE I	0	1	1	0	0	0	1	0	0	0
LINE MUTE II	0	0	0	0	0	1	0	0	0	0
REMOTE CONTROL SIGNAL MUTE	0	0	0	0	0	1	0	0	0	0
2 WAY BEEP	1	1	0	0	1	0	0	0	0	1

D5,D4,D3 → AS8,AS10,AS7,AS11							
MODE	D5	D4	D3	AS8	AS10	AS7	AS11
CLA	0	0	0	0	0	0	0
OGM REC	0	0	1	0	0	1	0
BEEP REC	0	0	1	0	0	1	0
OGM PLAY	0	1	0	0	1	0	0
PLAY	0	1	0	0	1	0	0
DICTIONATION REC	0	0	1	0	0	1	0
OGM OUT	1	1	0	1	1	0	0
ICM REC	0	1	1	0	1	1	0
2 WAY REC	0	0	1	0	0	1	0
CALL COUNTER OUT	1	1	0	1	1	0	0
ICM OUT	1	1	0	1	1	0	0
ALARM	0	1	0	0	1	0	0
OGM CHANGE	0	1	1	0	1	1	0
LINE AMP MUTE I,II	0	1	0	0	1	0	0
REMOTE CONTROL SIGNAL MUTE	0	1	0	0	1	0	0
2 WAY BEEP	1	1	1	1	1	1	1

D6 → AS12		
MODE	D6(MUTE)	AS12
LINE IN MUTE	0	1

LA2800N

T-75-07-15

Description of Equivalent Circuit Block Diagram

- 1) D1 to D6 (pin 30 to pin 24)
Each pin can be driven by the microcomputer output. D0 to D2 switches and D3 to D5 switches are independent.
- 2) BIAS
Provides V_{ref} (pin 14) of approximately 4.2V.
- 3) Peramp
Amplifies the input signal at pins 4 to 8. The open-loop gain characteristic of the amp is shown in Fig.G-6.
- 4) ALC
The ALC operates in the input range of -54dBs to approximately -10dBs. The ALC saturation output level is 570mA. The ALC characteristic is shown in Fig.G-1

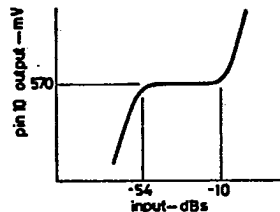

- 5) MUTE(AS12)
Mutes the preamp output. When pin 24 is at "1" level, the AS12 opens.
- 6) Recamp
Amp used for recording
- 7) V/I(pin1, pin2) recording current
V/I conversion is made to draw the recording current for DC bias. The conversion gain and bias current can be changed arbitrarily by external constants connected to pin 1 and pin 2. When the OGM head and the ICM head have the same characteristics, the number of parts can be reduced by shorting pin 1 and pin 2.
- 8) Lineamp
Buffer amp for line output
- 9) Beep tone det
A microcomputer is used to identify the beep tone signal or remote control signal included in the pin 22 output.
Zero-cross comparator for pin 12 input signal (V12)
The duty ratio of the pin 22 output waveform is shown in Fig.G-3.



- 10) Voice det
Detects the presence or absence of a call. Pin 12 input signal (V12) level detection
 $V_{12} \geq -24\text{dBs}$ -----Pin 18 "L"
Adjustment of detection level. R can be used to set the detection level. Refer to the figure shown right.
The Voice detection sensitivity - V_{CC} characteristic is shown in Fig.G-4

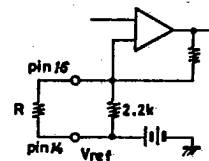

LA2800N

T-75-07-15

- 11) CPC det (Calling Party Control)
Detects ON-hook of calling party.

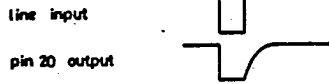

The relation between peak value and pulse width of the line input signal that can be detected is shown in Fig.G-5

Mode Description

- 1) CLA (Clear): Input(pin 6), Output(pin 22)
 - . Standby mode
 - . Beep tone usable for microcomputer control
- 2) OGM REC (Outgoing Message Rec.): Input(pin 7), Output(pins 5,22)
 - . Outgoing message recording
- 3) BEEP REC: Input(pin 8), Output(pins 5,22)
 - . BEEP signal recording before and after outgoing message
- 4) OGM PLAY: Input (pin 5), Output(pins 13,22)
 - . Outgoing message playback and check
- 5) PLAY: Input (pin 6), Output(pins 13,22)
 - . Incoming message playback
 - . Recorded dictation playback
- 6) DICT REC: Input(pin 7), Output(pins 6,22)
 - . MIC-used dictation recording (recording of message to family or brief message contents)
- 7) OGM OUT: Input(pin 5), Output (pins 13,22,23)
 - . Outgoing message line-output (at remote control operation mode, etc)
 - . Outgoing message playback
- 8) ICM REC (Incoming Message Rec.): Input(pin 4), Output(pins 6,13,22)
 - . Incoming message recording (remote-controlled from the place where you have gone)
 - . Recording of dictation sent from the place where you have gone
- 9) 2-WAY REC: Input(pin 4),Output(pins 6,22)
 - . Recording of both conversations while talking over the telephone
 - . Incoming message recording
- 10) CALL COUNTER OUT: Input (pin 8), Output(pins 13,22,23)
 - . Speaker-output and line-output of alarm sound
 - . Used when sending alarm sound at the end of outgoing message
 - . Possible to send back the call of you calling party to surprise such party by line-inputting to pin 8.
- 11) ICM OUT: Input(pin 6), Output(pins 13,22,23)
 - . Incoming message playback
 - . Listening to the incoming message through the telephone installed in the place where you have gone.
 - . Incoming message line-output
 - . Recorded dictation playback
- 12) ALARM: Input(pin 8), Output(pins 13,22)
 - . Speaker-output of alarm sound at the time of recording start
 - . Speaker-output of various kinds of signal
- 13) OGM CHANGE: Input (pin 4), Output (pins 5,13,22)
 - . Change of outgoing message by remote control from the place where you have gone
- 14) LINE MUTE I
 - . Same as OGM PLAY

LA2800N

T-75-07-15

- 15) LINE MUTE II
 - . Same as PLAY
- 16) REMOTE CONTROL SIGNAL MUTE
 - . Same as PLAY
- 17) 2-WAY BEEP: Input(pin 8), Output(pins 6,13,22,23)
 - . Speaker-output of alarm sound and incoming message recording and also line-output to your calling party
 - . Your calling party is made known that the incoming message is being recorded.
 - . Line-output is down 6dB from line-output at other mode.
- 18) LINE IN MUTE: D6(pin 24)
 - . Output muting

D6(pin 24)	AS12	
1(H level)	0(open)	MUTE
0(L level)	1(closed)	MUTE release

[Reference] General Description of LA4070

- Functions**
- . Power amp ($V_{CC}=9V, R_L=8ohms, P_o=0.5W$)
 - . 5V regulator ($I_{OUT}=70mA$ max)
 - . Driver ($200mA$ max X 2, $100mA$ max X 2, with killer diode)

Case Outline: DIP-14T

Main Characteristics

		min	typ	max	unit
Power Amp Gain	$f=1kHz, R_L=8ohms, R_g=600ohms$	20	22	24	dB
Power Amp Output	THD=10%		0.5		W
Power Amp Distortion	$P_o=0.2W$		0.5	1.5	%
Regulator Output Voltage		4.5	5.0	5.5	V
Regulator Output Current				70	mA
Driver (Active-low)	$I_{OUT}=200mA$ (Pins 9,11)	0.35	0.5		V
Output Saturation Voltage	$I_{OUT}=100mA$ (Pins 5,7)	0.35	0.5		V

Equivalent Circuit Block Diagram

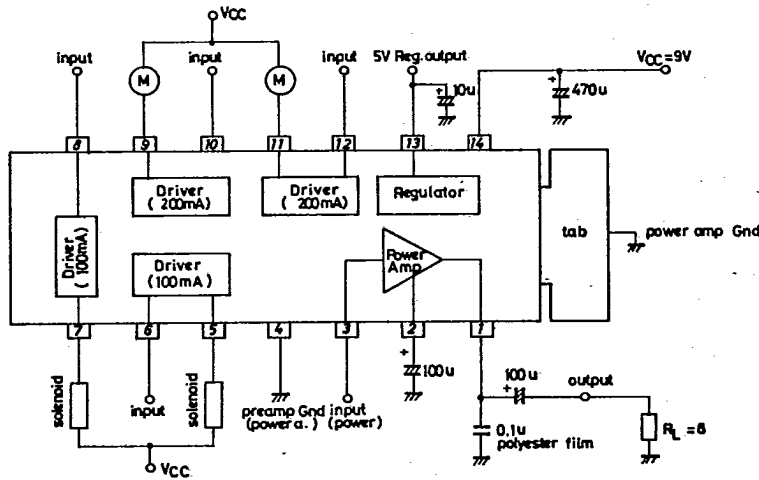

LA2800N

T-75-07-15

Fig.G-1 Preamp ALC Characteristic, Distortion

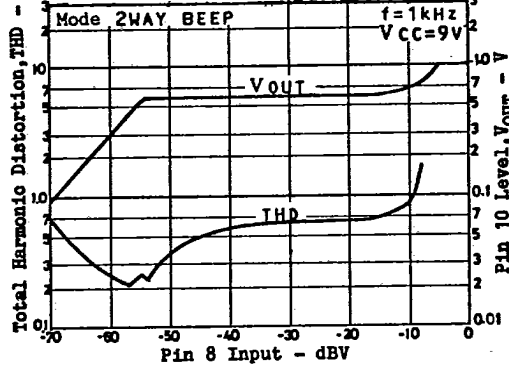

Fig.G-2 Input - Output Characteristic, Distortion

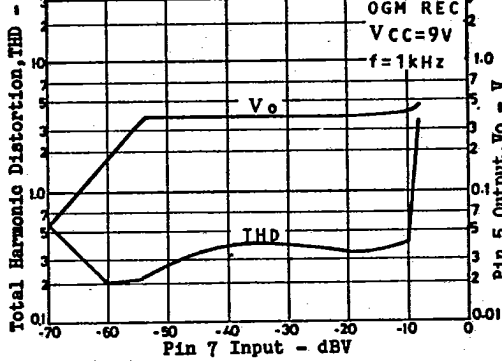

Fig.G-3 Beep Tone, Input - Duty Ratio

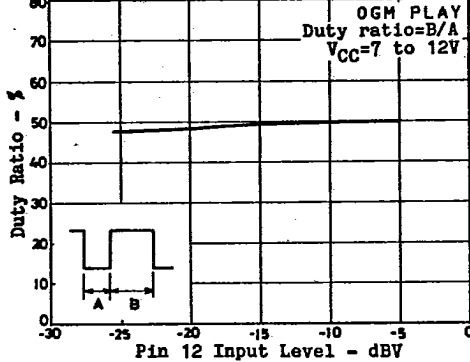

Fig.G-3 Beep Tone, VCC - Duty Ratio

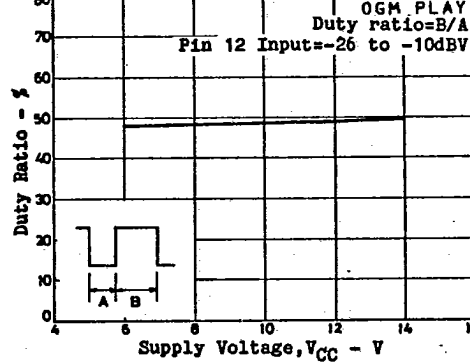

Fig.G-4 Voice Detector Detection Sensitivity

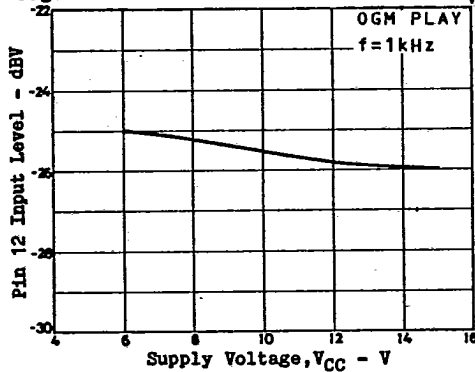

Fig.G-5 CPC Line Input - Response Pulse Width

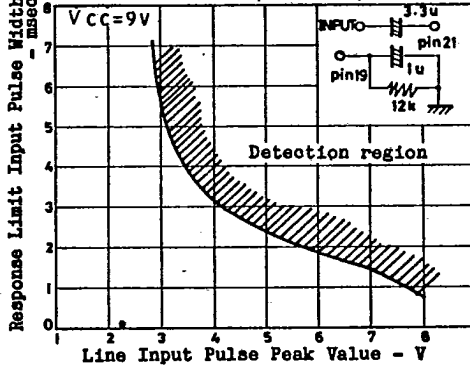

Fig.G-6 Preamp, f - VGO

