

### Specifications

Parameter	Unit	Minimum	Typical	Maximum
Center Frequency	MHz	70.987	71	71.013
Insertion Loss	dB	-	20	23
1 dB Bandwidth	MHz	-	0.17	-
2 dB Bandwidth	MHz	0.2	0.24	-
3 dB Bandwidth	MHz	0.23	0.28	-
40 dB Bandwidth	MHz	-	0.76	0.8
50 dB Bandwidth	MHz	-	0.79	1.2
Passband Variation	dB	-	0.01	0.1
Absolute Delay	usec	-	4.37	4.5
Ultimate Rejection(Over $f_0 \pm 0.6\text{MHz}$ )	dB	50	51	-
Material Temperature coefficient	KHz/°C	0.071		
Ambient Temperature	°C	25		
Package Size	DIP3512 (35.0x12.8x4.7mm3)			

#### Notes:

1. All specifications are based on the test circuit shown
2. In production, devices will be tested at room temperature to a guardbanded specification to ensure electrical compliance over temperature
3. Electrical margin has been built into the design to account for the variations due to temperature drift and manufacturing tolerances
4. This is the optimum impedance in order to achieve the performance show

### Matching Configuration

INPUT  
50 Ω



OUTPUT  
50 Ω

**Source/Load Impedance=50 ohm**

Notes - Component values may change depending on board layout.



**SIPAT Co., Ltd.**  
( CETC No. 26 Research Institute )  
Nanping Huayuan Road No. 14  
Chongqing, China, 400060

Part Number	LBS07103		
Rev. Date	2006-10-12		
Rev.	1.0	Page 1/3	

*Package Dimension*

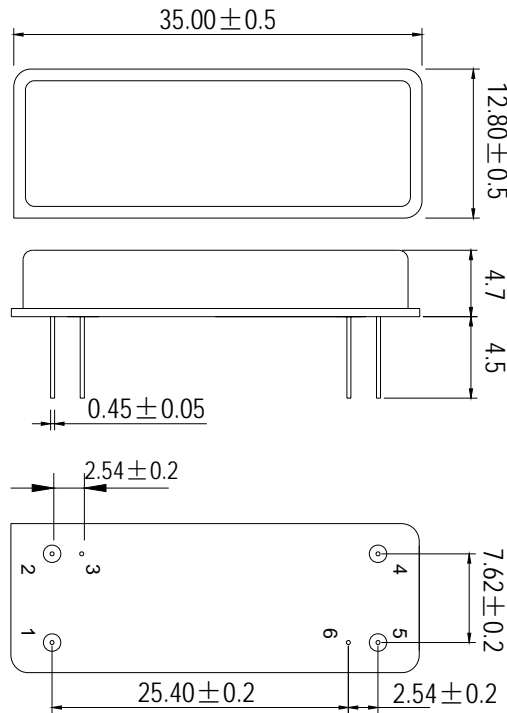

Input	1
Output	5
Ground	2,3,4,6

**Package: DIP3512**

**Unit: mm**



**SIPAT Co., Ltd.**  
( CETC No. 26 Research Institute )  
Nanping Huayuan Road No. 14  
Chongqing, China, 400060

Part Number	LBS07103	
Rev. Date	2006-10-12	
Rev.	1.0	Page 2/3

Typical Performance

Frequency Respond

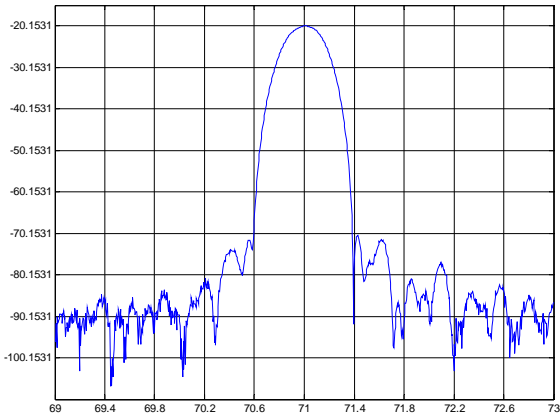

Passband Respond

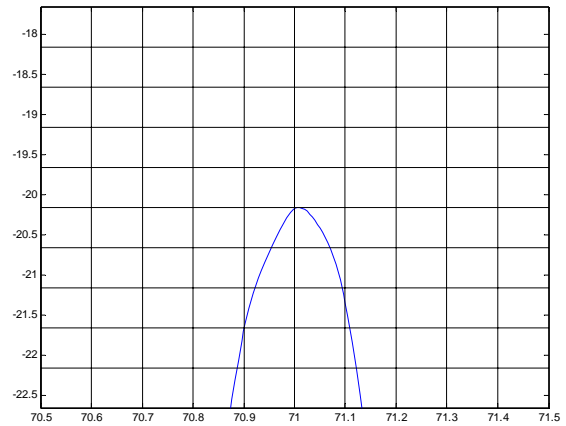

Group Delay Variation( $f_0 \pm 0.1\text{MHz}$ )

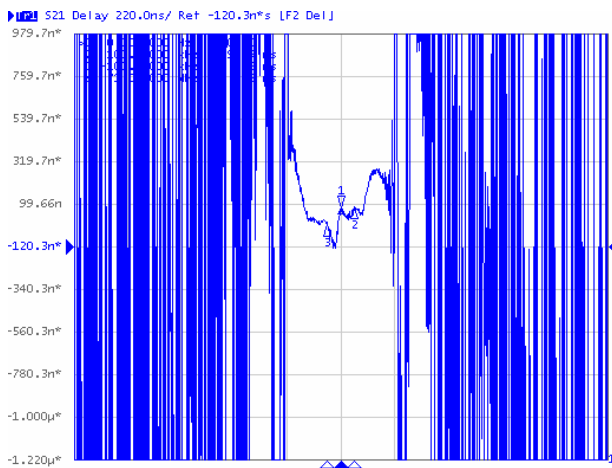

Phase Linearity( $f_0 \pm 0.1\text{MHz}$ )

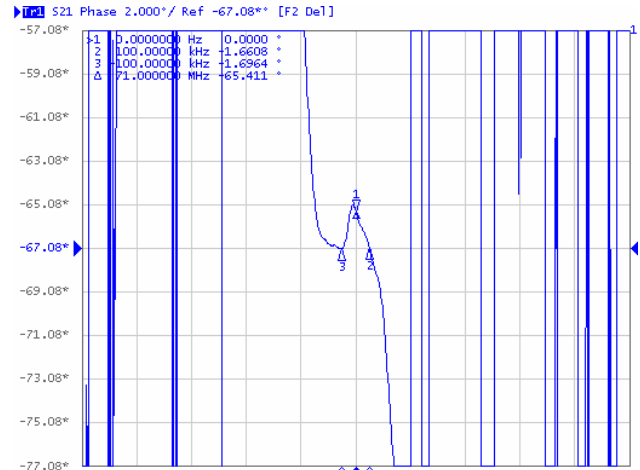

Smith Chart S11

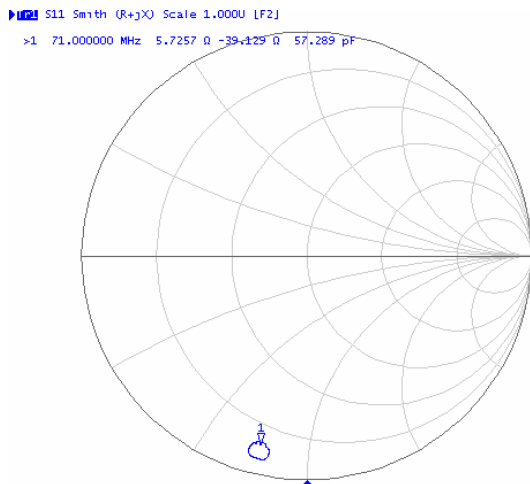

Smith Chart S22

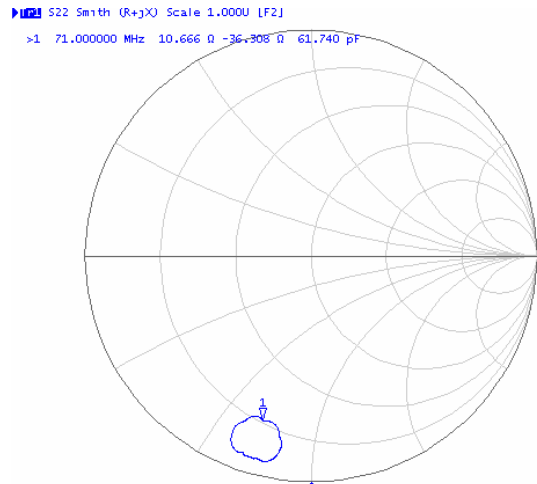

**SIPAT Co., Ltd.**  
( CETC No. 26 Research Institute )  
Nanping Huayuan Road No. 14  
Chongqing, China, 400060

Part Number	LBS07103	
Rev. Date	2006-10-12	
Rev.	1.0	Page 3/3