

LC503QBL1-30G-A

Features

- 5mm Package
- High Optical Power
- High Luminous Intensity
- Water Clear Lens
- All Plastic Mold Type
- This product has Stand-Offs



ATTENTION
OBSERVE PRECAUTIONS
ELECTROSTATIC
SENSITIVE DEVICES

Applications

- Outdoor Message Centers
- VMS
- Automotive Interior Lighting
- Traffic Signals
- Pedestrian Signals
- Decorative Lighting

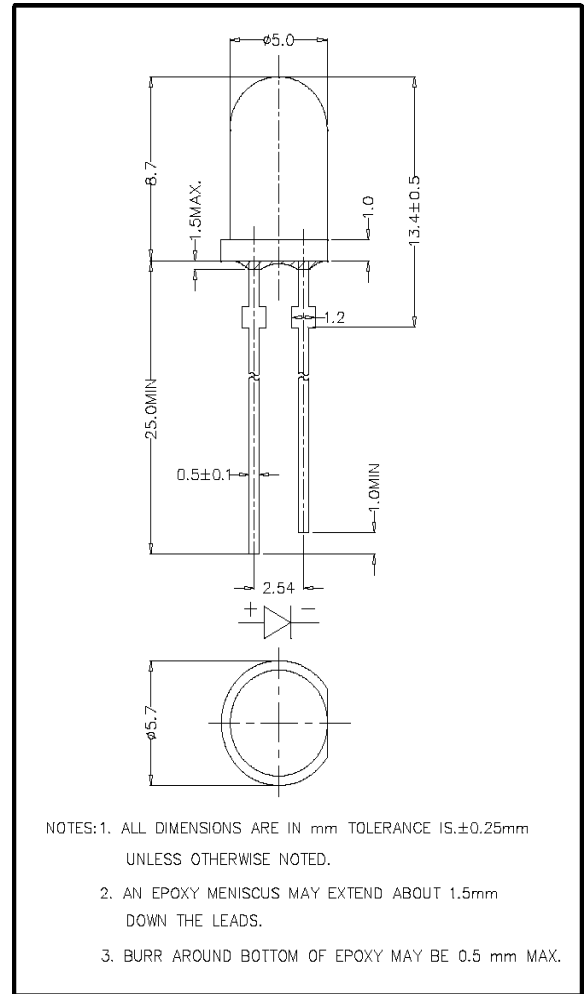

Maximum Ratings ($T_a=25^\circ\text{C}$)

Characteristic	Symbol	Max.	Unit
Forward Current	I_F	25	mA
Reverse Voltage	V_R	5	V
Power Dissipation	P_D	105.00	mW
Operating Temperature	T_{opr}	-40 ~ +95	$^\circ\text{C}$
Storage Temperature	T_{stg}	-40 ~ +100	$^\circ\text{C}$
Soldering Temperature	T_{sol}	260	$^\circ\text{C}$
Soldering Time	-	for 3 sec. max	-

Opto-Electrical Characteristics ($T_a=25^\circ\text{C}$)

Characteristic	Symbol	Test Condition	Min	Typ	Max	Unit
Forward Voltage	V_F	$I_F=20\text{mA}$	-	3.60	4.20	V
Reverse Current	I_R	$V_R=5\text{V}$	-	-	100	μA
Luminous Intensity	I_v	$I_F=20\text{mA}$	770.00	2100.00	-	mcd
Viewing Angle	$2\theta^{1/2}$	-	-	30°	-	deg.
Peak Wavelength	λ_p	$I_F=20\text{mA}$	-	468	-	nm
Dominant Wavelength	λ_d	$I_F=20\text{mA}$	-	470	-	nm
Spectral Line Half Width	$\Delta\lambda$	$I_F=20\text{mA}$	-	26	-	nm

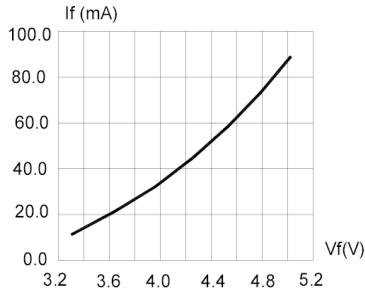

FIG.1 FORWARD CURRENT VS. FORWARD VOLTAGE.

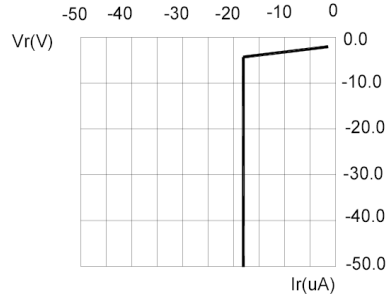

FIG.2 REVERSE CURRENT VS. REVERSE VOLTAGE.

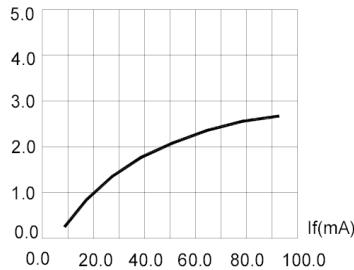

FIG.3 RELATIVE LUMINOUS INTENSITY VS. FORWARD CURRENT.

Half Power Δ WL=28nm
Domi WL= 470nm

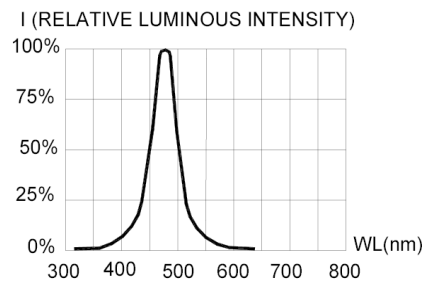

FIG.4 RELATIVE LUMINOUS INTENSITY VS. WAVELENGTH.

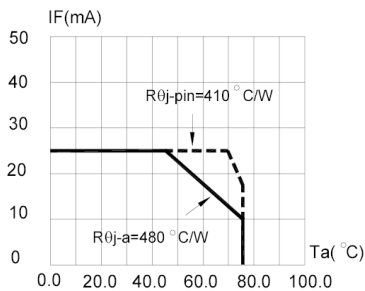

FIG.5 MAXIMUM FORWARD DC CURRENT VS AMBIENT TEMPERATURE (Tjmax=95 °C)

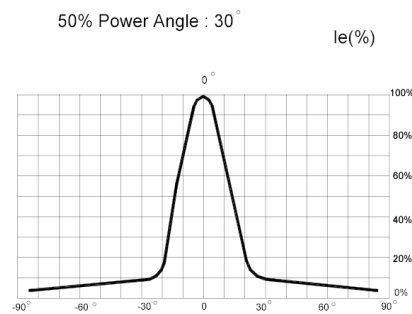

FIG.6 FAR FIELD PATTERN

1. Cathode PAD Area (0.18 X 0.18inch²)
2. Height above nominal seating plane in inches(0.3inch)