

FEATURES

- **Solid State Relay and Optocoupler in One Package**
- **Package—Single 8 Pin DIP**
- **I/O Isolation, 3750 V_{RMS}**
- **Surface Mount Option**
- **Optocoupler**
 - Bidirectional Current Detection
- **Solid-state Relay**
 - Typical RON 20 Ω
 - Load Voltage 350 V
 - Load Current 120 mA
 - Current Limit Protection
 - High Surge Capability
 - Linear, AC/DC Operation
 - Clean Bounce Free Switching
 - Low Power Consumption
 - High Reliability Monolithic Receptor

APPLICATIONS

- **General Telecom Switching**
 - On/off Hook Control
 - Dial Pulse
 - Ring Current Detection
 - Loop Current Sensing

Description

The LH1529 Telecom switch consists of an optically coupled solid state relay (SSR) and a bidirectional input optocoupler. The SSR is ideal for performing switchhook and dial-pulse switching while the optocoupler performs ring detection and loop current sensing functions. Both the SSR and optocoupler provide 3750 V_{RMS} of input to output isolation.

The SSR is integrated on a monolithic receptor die using high voltage BCDMOS technology. The SSR features low ON-resistance, high breakdown voltage and current-limit circuitry that protects the relay from telephone line induced lightning surges.

The optocoupler provides bidirectional current sensing via two antiparallel GaAs infrared emitting diodes. The opto channel provides a minimum CTR of 33% at 6 mA.

The LH1529 comes in a 8 pin, plastic DIP. To order packages with "S" bend leads, specify LH1529X00S.

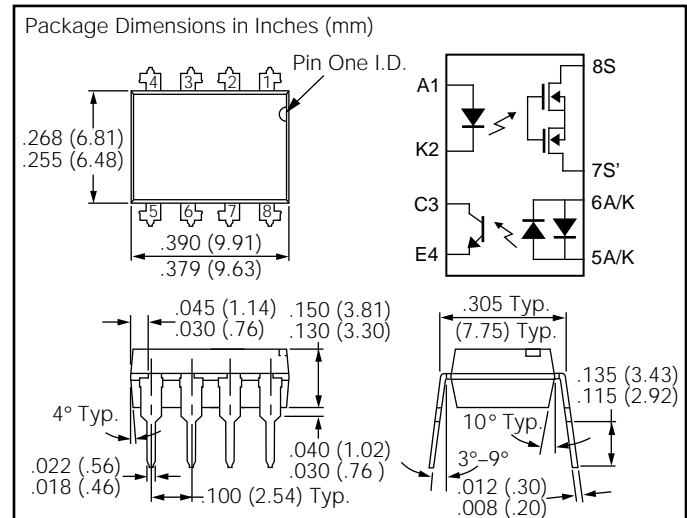

"S" Bend Leads: Package Dimensions in Inches (mm)

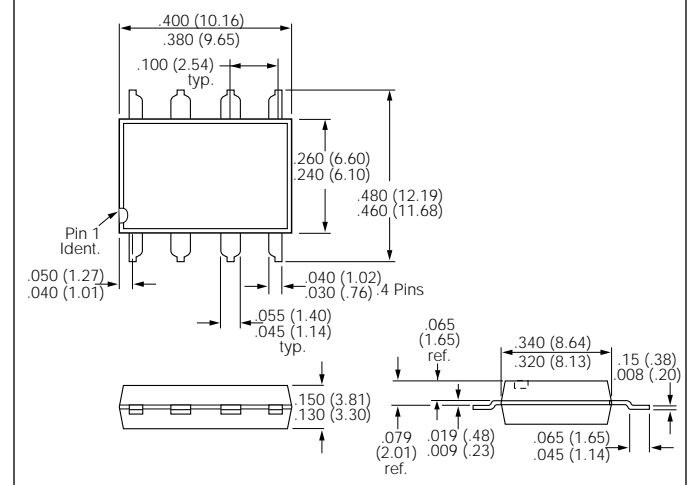

Absolute Maximum Ratings

Package

- Ambient Temperature Range..... -40 to +85°C
- Storage Temperature Range -40 to +150°C
- Soldering Temperature (t=10 sec. max.)..... 260°C
- Isolation Test Voltage..... 3750 V_{RMS}
- Isolation Resistance

- V_{IO}=500 V, T_A=25°C..... ≥10¹² Ω
- V_{IO}=500 V, T_A=100°C..... ≥10¹¹ Ω

Total Power Dissipation 600 mW

SSR

- LED Continuous Forward Current..... 50 mA
- LED Reverse Voltage (I_R≤10 μA)..... 8 V
- DC or Peak AC Load Voltage (I_L≤50 μA)..... 350 V
- Continuous DC Load Current 120 mA

Optocoupler

- LED Continuous Forward Current..... 50 mA
- LED Reverse Voltage (I_R≤10 μA)..... 3 V
- Collector to Emitter Breakdown Voltage..... 30 V
- Phototransistor Power Dissipation..... 150 mW

Electrical Characteristics ($T_A=25^\circ$)

Parameter	Symbol	Min.	Typ.	Max.	Unit	Test Condition
SSR						
LED Forward Current for Switch Turn-on	I_{Fon}		0.7	2.0	mA	$I_L=100$ mA, $t=10$ ms
LED Forward Current for Switch Turn-off	I_{Foff}	0.2	0.6		mA	$V_L=\pm 300$ V
LED Forward Voltage	V_F	1.15	1.26	1.45	V	$I_F=10$ mA
ON-Resistance	R_{ON}	12	20	25	W	$I_F=5$ mA, $I_L=\pm 50$ mA
OFF-Resistance	R_{OFF}		5000		G Ω	$I_F=0$ mA, $V_L=\pm 100$ V
Current Limit	I_{limit}	170	210	250	mA	$I_F=5$ mA, $t=5$ ms
Output Off-state Leakage Current			0.02	200 1.0	nA μ A	$I_F=0$ mA, $V_L=\pm 100$ V $I_F=0$ mA, $V_L=\pm 350$ V
Output Capacitance Pins 7 to 8			55 10		pF pF	$I_F=0$ mA, $V_L=1$ V $I_F=0$ mA, $V_L=50$ V
Turn-on Time	T_{on}		1.3	2.5	ms	$I_F=5$ mA, $I_L=50$ mA
Turn-off Time	T_{off}		0.6	2.5	ms	$I_F=5$ mA, $I_L=50$ V
Optocoupler						
LED Forward Voltage	V_F	0.9	1.2	1.5	V	$I_F=10$ mA
DC Current Transfer Ratio	CTR	33	165		%	$I_F=6.0$ mA, $V_{CE}=0.5$ V
Saturation Voltage	V_{CEsat}		.07	0.5	V	$I_F=16.0$ mA, $I_C=2$ mA
Dark Current Leakage	I_{CEO}			500	nA	$I_F=0$ mA, $V_{CE}=5$ V
Trickle Current Leakage	I_{CEO}			1	μ A	$I_F=5$ μ A, $V_{CE}=5$ V

Figure 1. Recommended operating conditions

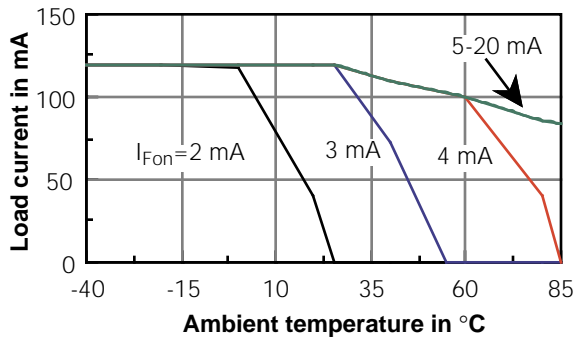

Figure 3. Typical SSR current vs. voltage

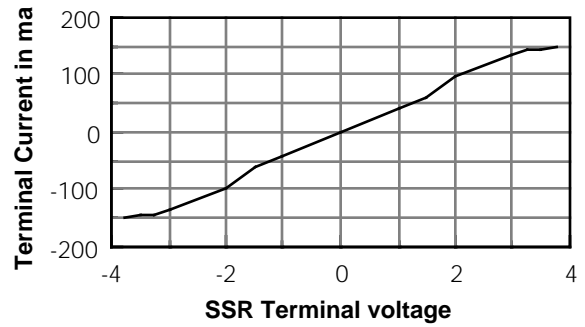

Figure 2. LED forward current vs. forward voltage

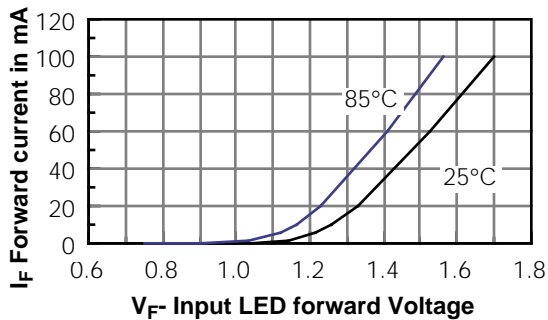

Figure 4. Change in ON-resistance vs. LED current

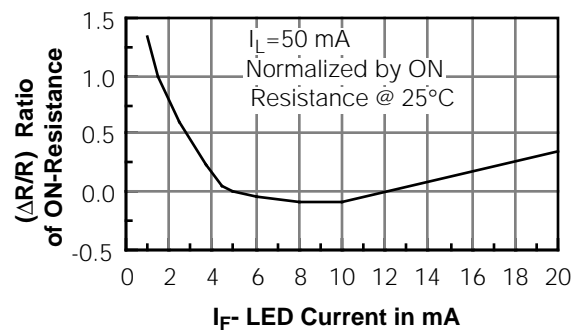

Figure 5. Change in ON-resistance vs. temp.

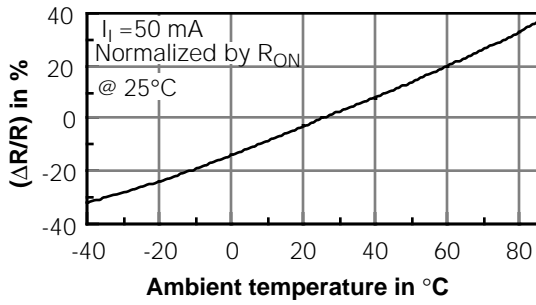

Figure 6. Turn-on current vs. temperature

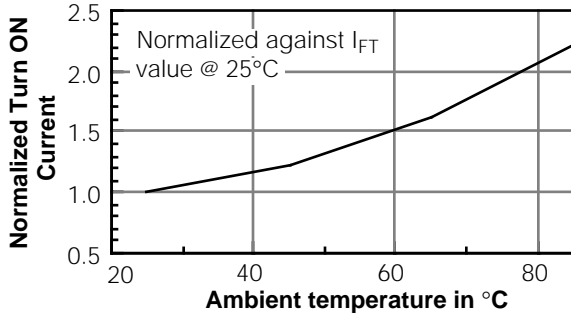

Figure 7. Current limit vs. temperature

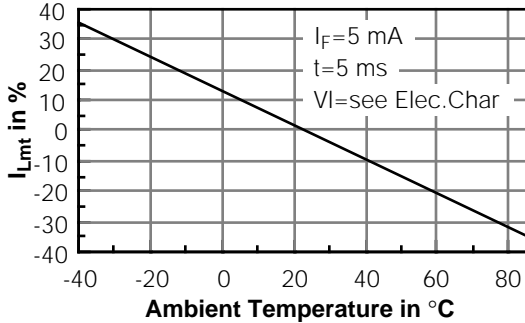

Figure 8. SSR turn-on time vs. resistive load

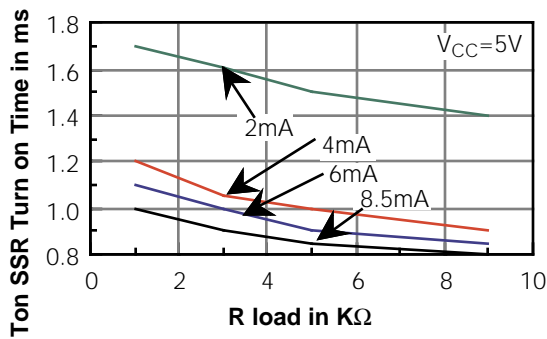

Figure 13. Switching test circuit for SSR channel

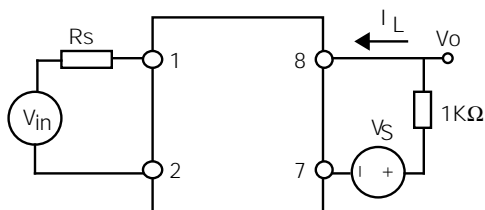

Figure 9. Collector current vs. collector voltage

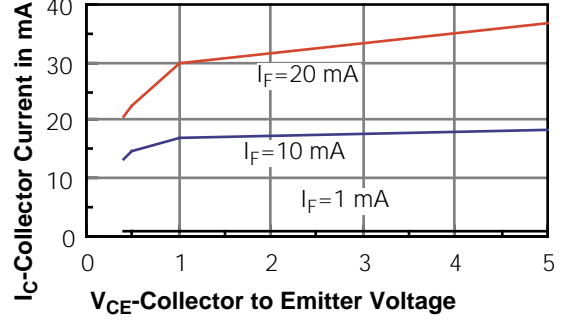

Figure 10. Collector current vs. collector voltage

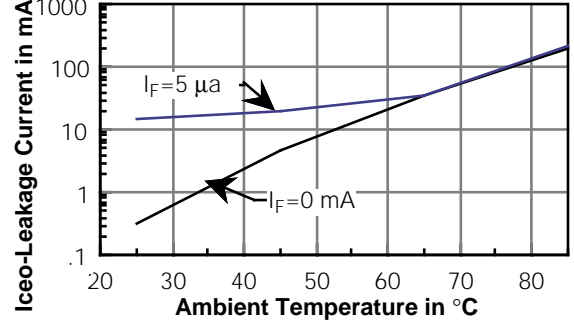

Figure 11. I_CEO leakage current vs. temperature

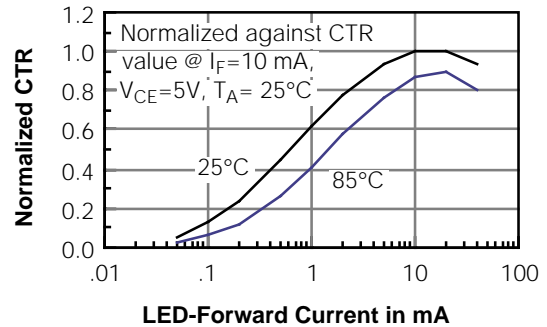

Figure 12. Non-saturated current transfer ratio

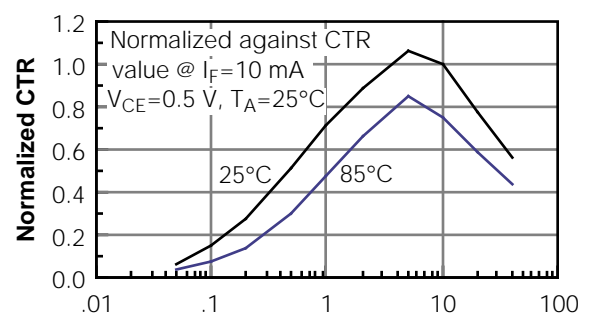

Figure 14. Switching waveform

